



Advisory Circular

Subject: FLIGHT TEST GUIDE FOR
CERTIFICATION OF TRANSPORT
CATEGORY AIRPLANES

Date: 3/31/98 **AC No:** 25-7A
Initiated By: ANM-110 **Change:**

- 1. PURPOSE.** This revised advisory circular (AC) provides updated guidance for the flight test evaluation of transport category airplanes. These guidelines provide an acceptable means of demonstrating compliance with the pertinent regulations of 14 CFR part 25. The methods and procedures described herein have evolved through many years of flight testing of transport category airplanes and, as such, represent current certification practice. Like all AC material, these guidelines are not mandatory and do not constitute regulations. They are derived from previous FAA experience in finding compliance with the airworthiness requirements and represent methods and procedures found to be acceptable by that experience. Although mandatory terms such as "shall" and "must" are used in this AC, because the AC method of compliance is not in itself mandatory, these terms apply only to applicants who seek to demonstrate compliance by use of the specific methods described in this AC.
- 2. CANCELLATION.** AC 25-7, "Flight Test Guide for Certification of Transport Category Airplanes," dated April 9, 1986.
- 3. BACKGROUND.** Since AC 25-7 was released on April 9, 1986, it has been the primary source of guidance for flight test methods and procedures to show compliance with the regulations contained in subpart B of part 25, which are related to airplane performance and handling characteristics. For certification flight testing to show compliance with other part 25 regulations, Order 8110.8, "Engineering Flight Test Guide for Transport Category Airplanes," provided guidance for internal FAA use in determining acceptable means of compliance. Order 8110.8, as revised on September 26, 1974, has been subject to five "change" updates to reflect significant policy changes; the last change being the removal of the subpart B-related material concurrent with the original release of AC 25-7. Order 8110.8 reflected the policy in place when Amendment 25-29 to part 25 was adopted, and the original release of AC 25-7 reflected an Amendment 25-59 time frame. Part 25 has been amended significantly since the two referenced documents were last revised and, likewise, guidance and policy have changed in many areas as experience has been gained. During this time period, many advances in technology have also taken place that require new or modified test techniques. This revision updates the original AC to incorporate the latest policy and guidance material

applicable to all sections of part 25. The material related to regulations outside of subpart B supersedes that contained in Order 8110.8, which has been cancelled accordingly upon issuance of this AC.

4. APPLICABILITY. These methods and procedures are promulgated, in the interest of standardization, for use during all transport category airplane flight test certification activities. This material is not to be construed as having any legal status and must be treated accordingly. The procedures set forth herein are one acceptable means of compliance with applicable sections of part 25. Any alternate means proposed by the applicant should be given due consideration. Applicants are encouraged to use their technical ingenuity and resourcefulness in order to develop more efficient and less costly methods of achieving the objectives of Part 25. Since these methods and procedures are only one acceptable means of compliance, individuals should be guided by the intent of the methods provided in this AC. As deviations from the methods and procedures described in this AC may occur, FAA certification personnel will coordinate what they consider to be major deviations with the Transport Standards Staff (ANM-110) of the Transport Airplane Directorate. If in their judgment, however, a deviation is considered to be minor, coordination with ANM-110 may not be necessary.

5. RELATED PUBLICATIONS. Certification personnel should be familiar with FAA Order 8110.4A, "Type Certification Process," and FAA Order 8100.5, "Aircraft Certification Directorate Procedures." In this AC, reference is made to other FAA advisory circulars that provide guidance on various aspects of type certification and supplemental type certification.

/s/ Ronald T. Wojnar
Manager, Transport Airplane Directorate
Aircraft Certification Service

CONTENTS

Paragraph
se No.

Pa

CHAPTER 1. GENERAL

1.	FAR 25.1	Applicability [RESERVED]	1
2.	FAR 25.2	Special Retroactive Requirements [RESERVED]	1

CHAPTER 2. FLIGHT

Section 1. GENERAL

3.	FAR 25.21	Proof of Compliance	31
	Figure 3-1	Weight Tolerance Limits	33
	Figure 3-2	Equivalent Weight Extrapolation	34
	Figure 3-3	Test Parameters That Normally Can Be Corrected	35
	Figure 3-4	Wind Profile Variation	36
4.	FAR 25.23	Load Distribution Limits [RESERVED]	42
5.	FAR 25.25	Weight Limits [RESERVED]	42
	FAR 25.27	Center of Gravity Limits [RESERVED]	42
6.	FAR 25.29	Empty Weight and Corresponding Center of Gravity [RESERVED]	42
7.	FAR 25.31	Removable Ballast [RESERVED]	42
8.	FAR 25.33	Propeller Speed and Pitch Limits	43

Section 2. PERFORMANCE

9.	FAR 25.101	General	71
	FAR 25.103	Stalling Speed (see paragraph 29)	71
10.	FAR 25.105	Takeoff	71
	FAR 25.107	Takeoff Speeds	71
11.	FAR 25.109	Accelerate-Stop Distance	80
	Figure 11-1	Accelerate-Stop Time Delays	80-7
	Figure 11-2	Accelerate-Stop Speed Vs. Distance	80-9
	Figure 11-3	Anti-Skid System Response Characteristics (On-Off System)	80-13
	Figure 11-4	Anti-Skid System Response Characteristics (Quasi-Modulating System)	80-15
	Figure 11-5	Anti-Skid System Response Characteristics (Fully Modulating System)	80-17
	Figure 11-6	Instantaneous Brake Force and Peak Brake Force	80-21
	Figure 11-7	Anti-Skid Efficiency-Wheel Slip Relationship	80-23
	Figure 11-8	Substantiation of the Optimal Slip Value	80-24
12.	FAR 25.111	Takeoff Path	81
13.	FAR 25.113	Takeoff Distance and Takeoff Run	88
	Figure 13-1	Takeoff Distance on a Dry Runway	89
	Figure 13-2	Takeoff Distance (All Engines Operating)	89
	Figure 13-3	Takeoff Distance on a Wet Runway	90
	Figure 13-4	Takeoff Run (Critical Engine Falls at V_{EF})	91
	Figure 13-5	Takeoff Run (All Engines Operating)	91
	Figure 13-6	Clearway Profiles	92
14.	FAR 25.115	Takeoff Flight Path	92

suitable correction factors. The FAA project engineers will then make a consolidated estimate of the total flight time required, allowing for overlapping, and adjust this in accordance with the "Test Time" outlined in paragraph 2a.

(3) This program will be arranged to permit the principal FAA flight test pilot to become thoroughly familiar with the operational aspects of the airplane in its anticipated service environment.

(4) All components of the airplane should be intensively operated and studied under all operating conditions expected in service and obtainable within the time and geographical limitations of the tests. Intensive operation means repeated operation of components in various sequences and combinations likely to occur in service. Particular attention should be given to potential sources of crew error, excessive crew workload or coordination, and the procedures that would be required in the event of malfunction of any component. The testing should also include an evaluation of operations with various Minimum Equipment List (MEL) items declared/simulated inoperative. This intensive type of testing should be conducted in all cases, but the length of time for which it is continued will depend upon the supplementary experience available for the particular type, as outlined in paragraph 2a, "Test Time."

(5) Ground inspections should be made at appropriate intervals during the test program to determine whether there are any failures or incipient failures in any of the components that might be a hazard to safe flight. The normal maintenance procedures should be employed during the F&R Program and carefully documented for review.

(6) When design changes are made during the course of the test, or when the official test airplane differs from those on which supplementary experience is obtained, the modified items will be rechecked in accordance with the above procedures. Every effort should be made to include such items in the program in such a way as to avoid unduly extending the overall test time. To this end, the Administrator may accept, in lieu of additional flight tests:

(i) special tests of the original and revised components in which the conditions causing failure are intensified.

(ii) ground qualification tests of differing components when the test methods have been validated as being representative of actual flight conditions.

f. Reports and Records.

(1) A log should be kept of all flights, and accurate and complete records kept of the inspections made of all defects, difficulties, and unusual characteristics and sources of crew error discovered during the tests, and of the recommendations made and action(s) taken. Items for which design changes may be required will be reported to the manufacturer and the appropriate FAA ACO.

(2) If supplementary experience is to be taken into account, similar records of such experience should be kept and submitted to the responsible FAA ACO, together with a list of the differences between the airplane on which the experience was obtained and the official test airplane. When supplementary experience is obtained on a large fleet of airplanes (for example, military operations) of the same or a comparable type (see paragraph 2e(6)), these records may consist of statistical summaries in lieu of complete records for each individual airplane.

(3) At the conclusion of the official tests, a summary report should be prepared by the participating pilots, engineering specialists, and manufacturing inspectors and made a part of the Type Inspection Report.

Figure 14-1	Takeoff Segments & Nomenclature	93
Figure 14-2	Net Takeoff Flight Path	94
FAR 25.117	Climb: General	94
FAR 25.119	Landing Climb: All-Engines Operating	95
FAR 25.121	Climb: One-Engine-Inoperative	96
FAR 25.123	En route Flight Paths	97
FAR 25.125	Landing	98
Figure 19-1	Landing Time Delays	103
Section 3. CONTROLLABILITY AND MANEUVERABILITY		
20.	General	121
Figure 20-1	Sample Pitch Tracking Task	129
Figure 20-2	A-PC Rating Criteria & Comparison to MIL Standard	130
Figure 20-3	Example of Minimum Permitted HQ Rating for A-PC Tendencies	131
21.	Longitudinal Control	135
22.	Directional and Lateral Control	140
23.	Minimum Control Speed	143
Section 4. TRIM		
24.	Trim [RESERVED]	157
Section 5. STABILITY		
25.	General [RESERVED]	171
26.	Static Longitudinal Stability	171
FAR 25.175	Demonstration of Static Longitudinal Stability	171
Figure 26-1	Longitudinal Static Stability	173
FAR 25.177	Static Directional and Lateral Stability	173
28.	Dynamic Stability	175

(i) For Intensive Experience. When the allowance is based on the total time of any one airplane in airline crew training and similar intensive operations, two hours of such operation may be considered equivalent to one hour of official testing.

(ii) For Miscellaneous Experience. When the allowance is based on the total time of any one airplane, five hours of such experience may be considered equivalent to one hour of official testing.

(iii) Reduction for Supplementary Experience. Whenever a reduction of official test time is desired on the basis of supplementary experience, such experience should be adequately recorded and submitted to the responsible FAA aircraft certification office as described in paragraph 2f(2).

b. Test Airplane. To facilitate completion of the type certification procedure, one airplane, in production configuration or equivalent, should be used for the official functional and reliability tests while another airplane (or airplanes) is used for the routine-type tests. In this case, the test time on at least one airplane would be sufficient to accomplish the objective of paragraph 1a(2).

c. Modified Types. The procedure outlined in paragraph d, below, applies to new type designs. When a design employs components (parts) identical to those used in previous designs, credit may be given for the supplementary experience available for such components. When a design is modified (e.g., several versions of the same basic type with different engines, propellers, etc.), the modified features and components should be rechecked in accordance with paragraph 2e(6), below.

d. Test Program. The project engineers of the responsible FAA ACO will propose guidelines for developing an F & R test program at the preflight Type Board meeting (prior to commencement of FAA certification flight tests) and coordinate this with the airplane manufacturer. Near the conclusion of the type certification tests, the FAA certification engineers will again meet with the manufacturer to review the experience gained in those tests, review changes made in the design, consider any additional supplementary experience, and revise the proposed F & R test program accordingly. In application, there is generally considerable overlap of the certification and F & R test programs, thus making a definite transition point indiscernible.

e. Planning and Execution of Test Program. The following points should be considered:

(1) The test program should be sufficiently well planned to enable its execution in an efficient manner without overlooking important items. Documentation should focus on the test objective(s) but does not necessarily require the type of detail maintained for type certification testing. The FAA project engineers will review the design features and equipment (appliances) with respect to the general objective and prepare a list showing:

(i) Components and systems to be checked in accordance with the procedures described in paragraph 2e(4).

(ii) A brief description of the operations to be performed, where these are not obvious (referencing any necessary operating instructions).

(iii) Special checks or likely critical conditions.

(iv) Estimated flight time required.

(2) Allowance may be made for those functional tests whose requirements are covered by 14 CFR part 25 type certification tests. Allowance may also be made for qualification-type testing of new features and equipment; however, the flight test program should be planned to determine the adequacy of these tests and the accuracy of the simulated operating environment (e.g., to determine whether the actual environmental conditions such as temperature variation, etc., are covered by the test simulations) when these may be critical, and to determine whether the installation and connected systems are satisfactory. This does not imply that flight tests must be conducted under the most severe outside air temperatures likely to be encountered in service. It should normally be possible to determine the effects of extreme outside temperatures on local temperatures by extrapolation or by

FUNCTIONAL AND RELIABILITY TESTS - § 21.35(b)(2)

1. Explanation.

a. In order to satisfactorily accomplish the objectives concerning additional flight tests and the extent thereof, the Administrator deems it necessary that:

(1) A comprehensive and systematic check be made, in flight, of the operation of all components to determine whether they "function properly" (i.e., perform their intended function without introducing safety hazards).

(2) Sufficient FAA test experience, and supplementary experience gained from operators' route proving tests, should be obtained and evaluated to give reasonable assurance that the airplane is "reliable" (i.e., should continue to function properly in service).

NOTE: In order to obtain wider experience, manufacturers are encouraged to cooperate with airlines or other responsible operators in operating airplanes with provisional type certificates under service conditions.

(3) Appropriate corrective action be taken when the need therefor is determined under subparagraphs (1) and (2) of this paragraph.

2. **Procedures.** The principal FAA flight test pilot for the project will act as coordinator of all flight activities during the official program, and that pilot (or a designated alternate) will participate in all flights. Other FAA personnel will not board the functional and reliability (F & R) airplane(s) during these activities, particularly in regard to flight plans and procedures, unless authorized by the flight test pilot. The manufacturer's pilot should be in command of all flights, but FAA pilots will fly the airplane to determine compliance with § 21.35(b)(2). Other FAA personnel (e.g., representatives of other divisions and specialists) will participate in the flight tests, when deemed necessary, to accomplish the purpose of the tests.

a. **Test Time.** It is highly desirable that function and reliability test programs be administered uniformly so that the program and flight time for a given project would be approximately the same, regardless of which FAA Aircraft Certification Office (ACO) administered the project. This is difficult to achieve without establishing fixed arbitrary test times, which would obviously be contrary to the intent of § 21.35 (b)(2). The following procedure, which permits considerable flexibility, is therefore established as guidance for administering F & R test programs:

(1) For a turbine engine-powered airplane incorporating engines of a type not previously certificated, § 21.35(f)(1) requires an F & R test program of at least 300 hours. This 300 hour minimum may also be applied to a complex new airplane model (e.g., an airplane with an electronic flight control system (fly by wire)). Though some F & R test requirements can be completed concurrently with certification testing (if relevant design conformity can be shown), experience has indicated the desirability of obtaining at least 150 hours on a production configured airplane. For a previously certificated airplane, the F & R program requirement should be commensurate with the modifications or changes.

(2) When supplementary experience is not taken into account, and the airplane is conventional with regard to complexity and design features and does not incorporate engines that have not been previously certificated (including derivative engines), it has been found that function and reliability tests can be performed within 300 hours. This time may be reduced if credit is granted for certain types of component testing (see paragraph 2e(2)) and for supplementary experience (see paragraph 2a(3)(iii)). However, it may be necessary to increase the 150-hour minimum F & R test requirement of § 21.35(f)(2) if difficulties are encountered or for unusual cases of complexity.

(3) When satisfactory supplementary experience is available and taken into account the following allowances should be used as a guide and applied with judgment in reducing the official flight test time. However, in any case, the official F & R test program should provide sufficient time to accomplish the objective of paragraph 1a(2) in accordance with the procedures described in paragraphs 2e(3) and (4).

Section 6. STALLS

FAR 25.201	Stall Testing.....	189
FAR 25.203	Stall Demonstration.....	189
FAR 25.207	Stall Characteristics.....	194
Figure 29-1	Stall Warning.....	197
Figure 29-2	Stall Test Time History.....	199
Figure 29-3	Stall C _L CG vs. Entry Rate.....	200
Figure 29-4	Stall C _L vs. Weight and Flap Setting.....	200
Figure 29-5	Stall Speeds vs. Weight and Flap Setting.....	201
	Thrust Effect on Stall C _L	201

Section 7. GROUND AND WATER HANDLING CHARACTERISTICS

FAR 25.231	General.....	211
FAR 25.233	Longitudinal Stability and Control.....	211
FAR 25.235	Directional Stability and Control.....	211
FAR 25.237	Taxing Condition [RESERVED].....	212
FAR 25.239	Wind Velocities.....	212
	Spray Characteristics, Control, and Stability on Water.....	213

Section 8. MISCELLANEOUS FLIGHT REQUIREMENTS

FAR 25.251	Vibration and Buffeting.....	221
Figure 31-1	Maneuvering Characteristics.....	224
Figure 31-2	(Speeds up to the Lesser of V _{IC} or M _{IC} or Buffet Onset) Maneuvering Characteristics.....	225
FAR 25.253	(Speeds between Figure 31-1 and V _{Df} or M _{Df}) High Speed Characteristics.....	225
FAR 25.255	Out-of-Trim Characteristics.....	229
Figure 33-1	Mistrimmed Maneuvering Characteristics.....	231

CHAPTER 3. STRUCTURE

[RESERVED]

CHAPTER 4. DESIGN AND CONSTRUCTION

Section 1. GENERAL [RESERVED]

Section 2. CONTROL SURFACES [RESERVED]

	Section 3. CONTROL SYSTEMS	
34.	FAR 25.671	General.....261
[35-45]	[RESERVED]	[RESERVED].....261
46.	FAR 25.701	Flap and Slat Interconnections261
47.	FAR 25.703	Takeoff Warning System [RESERVED].....262
	Section 4. LANDING GEAR	
[48-51]	[RESERVED]	[RESERVED].....283
52.	FAR 25.729	Retracting Mechanisms283
53.	FAR 25.731	Wheels284
54.	FAR 25.733	Tires [RESERVED].....286
55.	FAR 25.735	Brakes286
56.	FAR 25.737	Skis [RESERVED].....301
	Section 5. FLOATS AND HULLS	
[57-59]	[RESERVED]	[RESERVED].....311
	Section 6. PERSONNEL AND CARGO ACCOMMODATIONS	
[60-61]	[RESERVED]	[RESERVED].....323
62.	FAR 25.773	Pilot Compartment View323
[63-72]	[RESERVED]	[RESERVED].....323
	Section 7. EMERGENCY PROVISIONS	
73.	FAR 25.801	Ditching [RESERVED].....333
74.	FAR 25.803	Emergency Evacuation333
[75-83]	[RESERVED]	[RESERVED].....333
	Section 8. VENTILATION AND HEATING	
84.	FAR 25.831	Ventilation.....343
85.	FAR 25.832	Cabin Ozone Concentration [RESERVED].....343
86.	FAR 25.833	Combustion Heating Systems [RESERVED].....343
	Section 9. PRESSURIZATION	
87.	FAR 25.841	Pressurized Cabins.....353
88.	FAR 25.843	Tests for Pressurized Cabins.....353

FLIGHT CONDITION (Xc + Xem)	ATMOSPHERIC DISTURBANCE (Xa)								
	LIGHT		MODERATE		SEVERE				
	NFE	OFE	LFE	NFE	OFE	LFE			
PROBABLE CONDITION	S	S	A	A	C	C	C	C	C
IMPROBABLE CONDITION	A	A	C	C	C		C		

S = SATISFACTORY A = ADEQUATE C = CONTROLLABLE

FIGURE 12: Minimum HQ Requirements

A. TRIM & UNATTENDED OPERATION

Characteristics of the airplane to stay at or depart from an initial trim or unaccelerated condition.

- * Dynamic and flight-path response to pulse (3 axes)
- * Dynamic and flight-path response to atmospheric disturbance
- * Spiral stability (e.g., release at 40° bank)

B. LARGE-AMPLITUDE MANEUVERING

Generally, these are open-loop maneuvers in which the pilot attempts a significant change in airplane path, speed, or altitude in order to evaluate safe airplane capability, but not reflecting the normal daily commercial use of the airplane. Maneuvers may be initiated outside the NORMAL FLIGHT ENVELOPE and transition flight envelopes. Most of these maneuvers are representative of engineering airworthiness stability and control tests.

- * Pitch/Longitudinal
 - o Wind-up turn or symmetric pull-up/push-over
 - o Slow-down-turn at fixed g or on AOA or g-limiter
 - o Stall or AOA-limiter approach
 - o Push/pull off trim speed
- * Roll
 - o Rapid bank-to-bank roll
- * Yaw
 - o Sudden heading change
 - o Constant heading sideslip
- * Operational
 - o Pitch/roll upset recover
 - o Emergency descent
 - o Climbing/diving turn
 - o Takeoff/land windshear escape maneuver
 - o Go around/power application from low speed
 - o Arrest of high sink rate, at touchdown or level-off altitude
 - o Collision avoidance roll/pull
 - o Takeoff and landing flare with abuse or high crosswind

C. CLOSED-LOOP PRECISION REGULATION OF FLIGHT PATH

Generally, these are tightly-bounded, pilot closed-loop tasks performed in routine commercial flight. These controlling tasks are almost exclusively associated with the NORMAL FLIGHT ENVELOPE, or certainly not far outside the NFE boundary.

- * ILS and precision touchdown, various atmospheric disturbance and initial offset
- * Formation flying (as simulator for maneuver tracking)
- * SPD/ALT/HDG tracking, in various atmospheric disturbance and cockpit display status, for:
 - o Takeoff
 - o Climb
 - o Cruise
 - o Descent
 - o Hold
 - o Configuration changes/power changes
 - o Transition between aforementioned

Section 10. FIRE PROTECTION [RESERVED]

Section 11. MISCELLANEOUS [RESERVED]

CHAPTER 5. POWERPLANT

Section 1. GENERAL

89.	FAR 25.901	Installation [RESERVED].....	387
90.	FAR 25.903	Engines	387
	FAR 25.903(b)	Engine Isolation	387
	FAR 25.903(c)	Control of Engine Rotation.....	387
	FAR 25.903(d)	Turbine Engine Installations.....	388
	FAR 25.903(e)	Engine Restart Capability.....	389
	FAR 25.904	Automatic Takeoff Thrust Control Systems (AITCS).....	390
	FAR 25.905	Propellers.....	392
	FAR 25.907	Propeller Vibration [RESERVED].....	392
	FAR 25.925	Propeller Clearance [RESERVED].....	392
	FAR 25.929	Propeller Deicing.....	392
	FAR 25.933	Reversing Systems.....	393
	FAR 25.934	Turbojet Engine Thrust Reverser Sys. Tests [RESERVED].....	396
	FAR 25.937	Turbopropeller-Drag Limiting Systems.....	396
	FAR 25.939	Turbine Engine Operating Characteristics.....	398
100.	FAR 25.941	Inlet, Engine, and Exhaust Capability (RESERVED).....	398
101.	FAR 25.943	Negative Acceleration.....	399
102.	FAR 25.945	Thrust or Power Augmentation System [RESERVED].....	399

Section 2. FUEL SYSTEM

[103-108]	[RESERVED].....	419
109.	Unusable Fuel Supply	419
110.	Fuel System Hot Weather Operation.....	421
[111-116]	[RESERVED].....	423
117.	Fuel Tank Vents and Carburetor Vapor Vents	423
[118-120]	[RESERVED].....	424

Section 3. FUEL SYSTEM COMPONENTS

[121-126]	[RESERVED].....	445
127.	Fuel Jettisoning System.....	445

Section 4. OIL SYSTEM [RESERVED]

Figure 11: General HQ Task Categories

Section 5. COOLING

[128-130] [RESERVED].....481

Section 6. INDUCTION SYSTEM

131. FAR 25.1091 Air Induction497

132. FAR 25.1093 Induction System Leaking Protection.....499

[133-136] [RESERVED].....501

Section 7. EXHAUST SYSTEM

137. FAR 25.1121 General.....511

[138-140] [RESERVED]

Section 8. POWERPLANT CONTROLS AND ACCESSORIES

[141-154] [RESERVED].....521

Section 9. POWERPLANT FIRE PROTECTION

[155-158] [RESERVED].....537

159. FAR 25.1187 Drainage and Ventilation of Fire Zones537

[160-164] [RESERVED].....537

165. FAR 25.1197 Fire Extinguishing Agents537

[166-169] [RESERVED].....538

CHAPTER 6. EQUIPMENT

Section 1. GENERAL

170. FAR 25.1301 Function and Installation559

171. FAR 25.1303 Flight and Navigation Instruments592

172. FAR 25.1305 Powerplant Instruments [RESERVED].....594

173. FAR 25.1307 Miscellaneous Equipment [RESERVED].....594

174. FAR 25.1309 Equipment, Systems, and Installations594

Section 2. INSTRUMENTS: INSTALLATION

175. FAR 25.1321 Arrangement and Visibility [RESERVED].....605

176. FAR 25.1322 Warning, Caution, and Advisory Lights [RESERVED].....605

177. FAR 25.1323 Airspeed Indicating System.....605

178. FAR 25.1325 Static Pressure Systems608

179. FAR 25.1326 Pilot Head Indicator Systems [RESERVED].....609

180. FAR 25.1327 Magnetic Direction Indicator [RESERVED].....609

181. FAR 25.1329 Automatic Pilot System.....609

[182-185] Figure 181-1 Altitude Loss vs. Altitude Go-Around Mode617

[RESERVED].....625

Section 3. ELECTRICAL SYSTEMS AND EQUIPMENT

186. FAR 25.1351 General.....635

187. FAR 25.1353 Electrical Equipment and Installations.....637

188. FAR 25.1355 Distribution System.....639

189. FAR 25.1357 [RESERVED].....639

190. FAR 25.1363 Electrical System Tests.....639

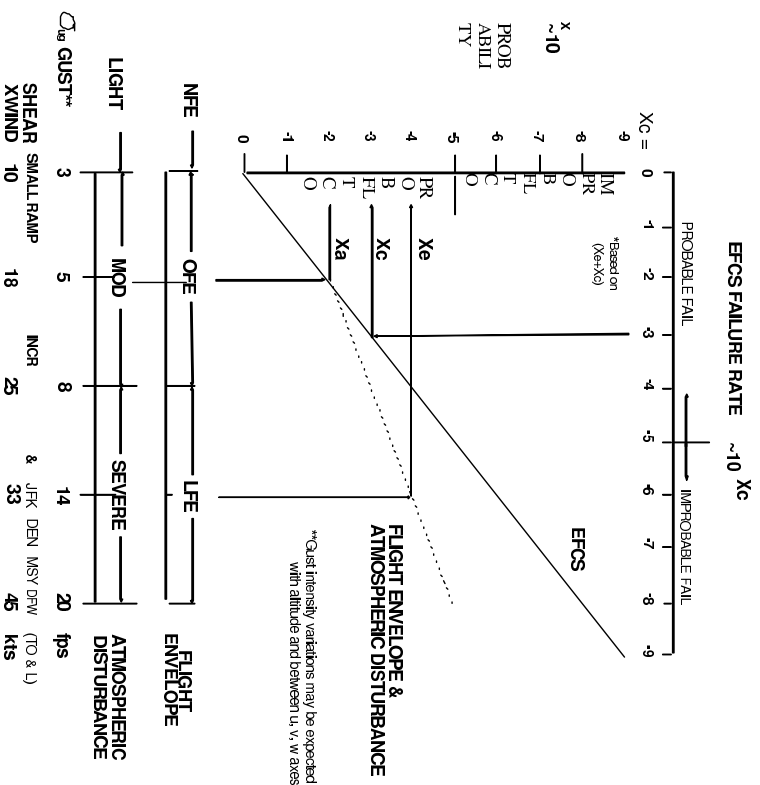

FIGURE 10: Probability Guidelines to determine HQ Requirements

Section 4. LIGHTS

191.	FAR 25.1381	Instrument Lights.....	651
192.	FAR 25.1383	Landing Lights.....	651
193.	FAR 25.1385	Position Light System Installation.....	651
[194-200]		[RESERVED].....	652
201.	FAR 25.1401	Anticollision Light System.....	652
202.	FAR 25.1403	Wing Icing Detection Lights	652

Section 5. SAFETY EQUIPMENT

[203-207]		[RESERVED].....	659
-----------	--	-----------------	-----

Section 6. MISCELLANEOUS EQUIPMENT

208.	FAR 25.1431	Electronic Equipment.....	669
[209-223]		[RESERVED].....	669

CHAPTER 7. OPERATING LIMITATIONS & INFORMATION

Section 1. [RESERVED]

Section 2. Operating Limitations [RESERVED]

Section 3. Markings and Placards [RESERVED]

Section 4. Airplane Flight Manual

224.	FAR 25.1581	General.....	679
[225-227]		[RESERVED].....	679

CHAPTER 8. AIRWORTHINESS/MISCELLANEOUS ITEMS

228.	Design and Function of Artificial Stall Warning and Identification Systems.....	701
229.	Reduced and Derated Thrust Takeoff Operations.....	704
230.	Runway Gradients Greater than ±2 Percent.....	705
231.	Performance Requirements for Flight in Icing Conditions.....	707
232.	Flying Qualities in Natural Icing Conditions.....	708
233.	Criteria for Approval of Steep Approach to Landing.....	709
234.	Takeoff and Landing on Unpaved Runways.....	713
235.	Accountability of Performance Degradation Relative Both Minor Design Changes (External Exposure) and Configuration Deviation List (CDL) Items.....	716
236.	Configuration Deviation List (CDL).....	717
237.	Spare Engine Pod 719	719
238.	Authorization for Ferry Flight with One Engine Inoperative.....	719
239.	Instrument Landing System Weather Minima.....	720
240.	Takeoff Performance Credit for Alternate Forward Center of Gravity Limits.....	721
241.	Performance Credit for Automatic Propeller Drag Reduction Devices.....	724
242.	Airplane Backing Using Reverse Thrust.....	725

APPENDICES

Appendix 1	History of Jet Transport Performance Standards (CAR 4b Special Regulations 422, 422A and 422B)	
Appendix 2	History of Accelerate-Stop Transition Time Development	
Appendix 3	Correction of Air Minimum Control Speed (VMCA) to Standard Conditions	
Appendix 4	Rudder Pedal Force-Limited Air Minimum Control Speed (VMCA)	
Appendix 5	One-G Stall Compliance Basis	
Appendix 6	Sample Flight Test Program [RESERVED]	
Appendix 7	FAA Handling Qualities Rating System	
Appendix 8	Functional and Reliability Tests (§ 21.35(b)(2))	

- Analyze Failures/Determine EFCS Operating state (Xc) Probability
- Predicted failure rates/check failure co-dependence
- Equipment Inoperative Dispatch under MEL
- Service Difficulty Records (continuing airworthiness)
- Assume Envelope Probabilities (Xe) and Atmospheric Probabilities (Xa) for Scenario
- Modify the Envelope Probability (to Xem) if Co-dependent with Atmospheric Condition (See Figure 5, Section D.) If not Co-dependent, Xem = Xe
- Continue with Cases Xc + Xa + Xem -> ≥ 10-9
- Develop: "Flight Condition"(Xc + Xem)
- PROBABLE FLIGHT CONDITION: -5 ≤ (Xc + Xem) < 0
- IMPROBABLE FLIGHT CONDITION: -9 ≤ (Xc + Xem) < -5
- Develop Tasks Ensure HQ Requirements Met

FIGURE 9. PROBABILITY COMBINATION LEADING TO HQ RATING

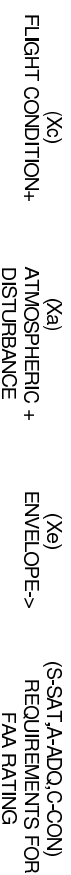

- Flight Test
- Simulator (high risk and specific atmospheric conditions)

CHAPTER 1 – GENERAL

1.-2. [RESERVED]

FAA HQ RATING	FAA DEFINITION	COMPARISON	
		CH*	MIL STANDARD LEVEL QUAL
SAT	Full performance criteria met with routine pilot effort and attention.	1-3.5	1 SAT
ADQ	Adequate for continued safe flight and landing; full or specified reduced performance met, but with heightened pilot effort and attention.	3.5-6.5	2 ACCEPT
CON	Inadequate for continued safe flight and landing, but controllable for return to safe flight envelope, and/or reconfiguration so that HQ are at least ADEQUATE.	6.5-9.0	3 CON

Note: * Cooper-Harper Rating

FIGURE 8: Pilot Ratings

CHAPTER 2 - FLIGHT

Section 1. GENERAL

3. PROOF OF COMPLIANCE - § 25.21.

a. **Explanation.** In an effort to provide the necessary guidelines for the flight test evaluation of transport category airplanes, without producing a cumbersome document, this advisory circular assumes a conventional transport airplane configuration. In general, a "conventional" airplane configuration is one with: distinct wing and fuselage elements that are joined together; aft-mounted horizontal and vertical stabilizers that are attached to the fuselage; and propulsion provided either by turbojet/turbofan engines that do not provide any significant increase in lift due to their operation or engine-driven propellers. The effects of non-conventional airplane configurations (e.g., blown flaps) on the compliance methods should be evaluated and determined based on the intent of the guidelines presented for conventional airplane configurations.

(1) Section 25.21(a) - Proof of Compliance.

(i) The burden of showing compliance with the flight requirements for an airworthiness certificate or a type certificate rests with the applicant. The applicant should, at his own expense and risk, conduct such official flight tests as required by the FAA to demonstrate compliance with the applicable requirements. During the certification process, the applicant should make available the airplane, as well as all of the personnel and equipment necessary to obtain and process the required data.

(ii) If the airplane flight characteristics or the required flight data are affected by weight and/or center of gravity (c.g.), the compliance data should be presented for the most critical weight and c.g. position. Unless it can be shown that the allowable c.g. travel in one or more axes (e.g., lateral fuel imbalance) has a negligible effect on the airworthiness requirements, compliance at the critical c.g. must be substantiated.

(iii) The gross weight and c.g. tolerances specified in paragraphs 3a(3)(ii)(A) and (D) are test tolerances and are not intended to allow compliance to be shown at less than critical conditions.

(iv) Section 25.21(a)(1) requires, in part, that the test airplane be in conformity with its type design specifications.

(A) This is interpreted as meaning the test airplane must be in conformity with its type design specification as relates to the particular test being conducted.

(B) Any deviation from conformity must be clearly shown to be of no consequence to the particular test being conducted. For example, if the slip resistant

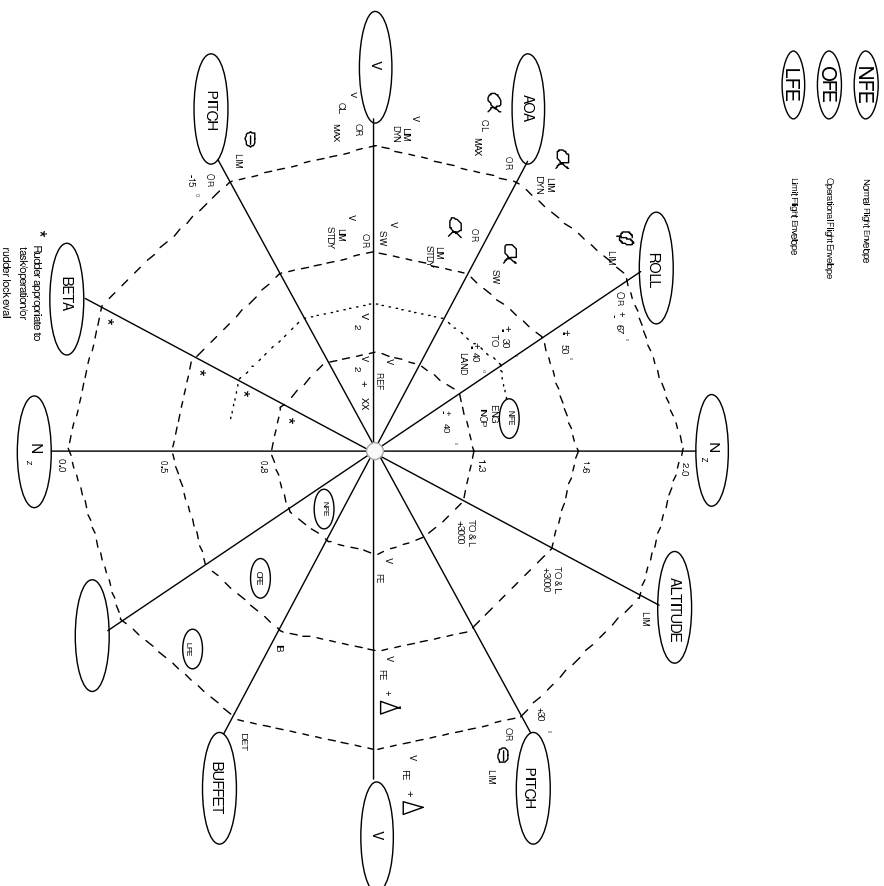

Figure 7: Flaps DOWN Flight Envelopes

escape surface required by §25.810(c) is not installed, it must be shown that its presence would have no effect on measured airplane performance and flight characteristics.

(2) Section 25.21(c) – Proof of Compliance (Altitude Effect on Flight Characteristics).

- (i) Any of the flying qualities, including controllability, stability, trim, and stall characteristics, affected by altitude should be investigated for the most adverse altitude conditions approved for operations and limited, as appropriate, in accordance with § 25.1527.
- (ii) Consideration should be given in the test program to aerodynamic control system changes with altitude (e.g., control throws or auto slats which are sometimes inhibited by Mach number at altitude).

(3) Section 25.21(d) – Proof of Compliance (Flight Test Tolerances).

(i) To allow for variations from precise test values, certain tolerances during flight testing should be maintained. The purpose of these tolerances is to allow for variations in flight test values from which data are acceptable for reduction to the value desired. They are not intended for tests to be routinely scheduled at the lower weights, or to allow for compliance to be shown at less than the critical condition; nor are they to be considered as allowable inaccuracy of measurement. As an example, when demonstrating stability with a specified trim speed of $1.4V_{S1}$, the trim speed may be $1.4V_{S1} \pm 3$ knots or 3 percent; however, no positive tolerance is permitted when demonstrating the minimum prescribed trim speed of $1.4V_{S1}$ (Ref. § 25.161).

(ii) Where variation in the parameter on which a tolerance is allowed will have an effect on the results of the test, the results should be corrected to the most critical value of that parameter within the operating envelope being approved. If such a correction is impossible or impractical (e.g., performance at forward c.g.), the average test conditions should assure that the measured characteristics represent the actual critical value.

(A) Weight limits. Figure 3-1, below, presents weight tolerances that have been found acceptable for the specified flight tests. Many flight tests need to be conducted at or very near the maximum operating weight for the airplane configuration, particularly those tests used to establish Airplane Flight Manual performance information. As noted in paragraph (i), above, the purpose of the test tolerances is to allow for variations in flight test values, not to routinely schedule tests at less than critical weight conditions or to allow for compliance to be shown at less than the critical weight condition.

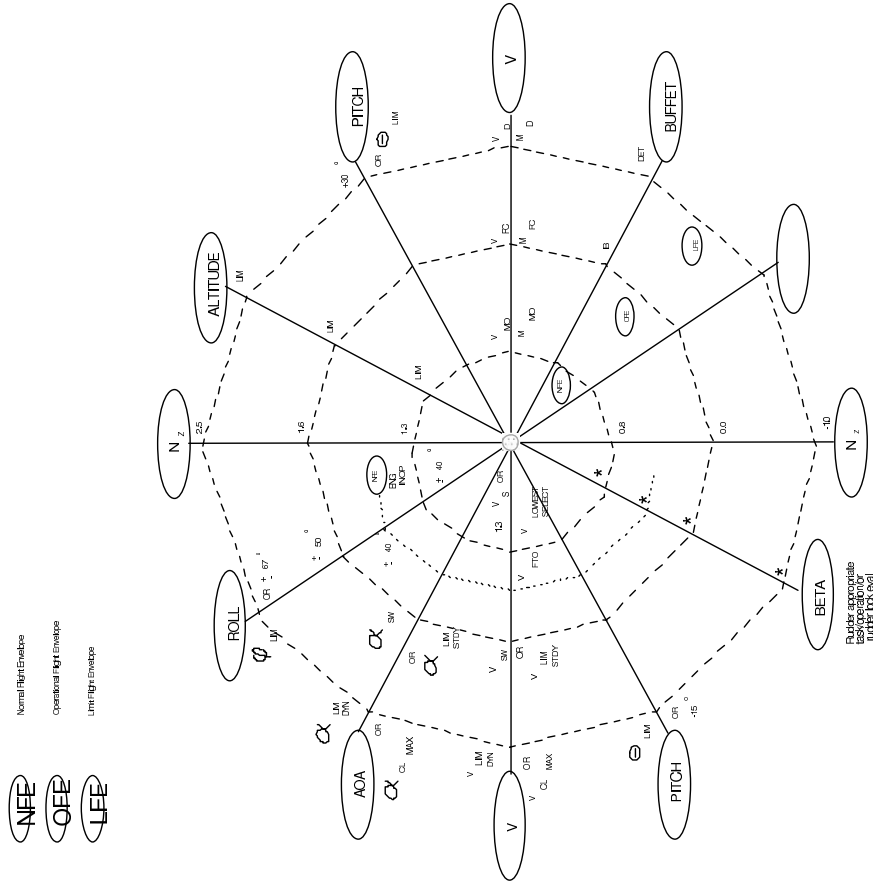

Figure 6: Flaps UP Flight Envelopes

FIGURE 3-1. WEIGHT TOLERANCE LIMITS

Flight Test Conditions	Weight Tolerance Limit	
	+5%	+10%
Stall Speeds	X	
Stall Characteristics		X
Climb Performance	X	
Takeoff Flight Paths	X	
Landing Braking Distance	X	
Landing Air Distance	X	
Takeoff Distance & Speed	X	
Accelerate-Stop Distance	X	
Maximum Energy RTOs	X	
Minimum Unstick Speed		X

(1) For follow-on airplane certification programs (e.g., minor gross weight increase), where it is desired to use an existing certificated data base from an aerodynamically similar model of the same airplane type, the test weight tolerance limits of Figure 3-1 have also been applied as extrapolation limits to minimize additional test requirements.

(2) For follow-on airplane certification programs, test data may be extrapolated to higher gross weights than specified in Figure 3-1, if the available test data includes an adequate range of weights and an appropriate number of points at the highest weight tested. If the test data analysis verifies the predicted effect of weight, then other extrapolation limits may apply.

(3) Equivalent weight extrapolation limits. For follow-on airplane certification programs where it is desired to increase a maximum operating weight based on existing certified performance parameters that have weight as one of their independent terms, those parameters should be examined for equivalent compliance with the weight tolerance limits of Figure 3-1. An example would be the reduction of an airplane's landing flap position, to one approved on a similar model of the same airplane type, which would incur an increase in landing speeds and brake energy, relative to the original certificated landing flap, at any given weight. The brake energy, at the maximum certificated landing flap, should be calculated for the reduced landing flap. This brake energy should account for the increased landing speeds and reduced aerodynamic drag associated with the reduced flap setting. It should then be determined what "equivalent" gross weight would have rendered that brake energy with the original landing flap (see Figure 3-2). The resulting "equivalent" gross weight should not exceed the certificated maximum landing weight by more than the five percent weight extrapolation limit specified in Figure 3-1. If the "equivalent" gross weight (at the existing landing flap setting) is not more than five percent greater than the certificated

Figure 5 (CONT'D)

HQR METHOD ELEMENT	ISOLATED PROBABILITY OF OCCURRENCE (at limit boundary)
SEVERE: Turbulence that causes large, abrupt deviations in altitude and/or attitude. Usually causes large variations in indicated airspeeds. Crosswinds substantially in excess of the minimum required crosswind to be demonstrated safe for takeoff and landing.	10 ⁻⁵
C. FLIGHT CONTROL SYSTEM FAILURE STATE	
Normal Operation:	10 ⁰
Probable Failures:	10 ⁰ - 10 ⁻⁵
Improbable Failures:	10 ⁻⁵ - 10 ⁻⁹
D. COMBINATION GUIDELINES	

The above occurrence probability guidelines apply in isolation and should be modified when interrelationships exist according to the design or intended or expected operation of the airplane. For example, a severe windshear event may generate an Operational Flight Envelope or Limit Flight Envelope escape task at 10⁰ not 10⁻³ or 10⁻⁵ as shown above, in the limit since the operational procedure for escape would be to pull toward the AOA limit in windshear, perhaps experiencing overshoots of the steady value. Similarly, an airplane may experience overspeed, from VMO cruise, into the OFE due to a gust, in which the OFE task probability would be 10⁰, not 10⁻³ in the limit. This probability adjustment concept would apply to EFCs failure cases where, for example, loss of warnings or exposure to reduced airplane stability might contribute to excursions outside the NFE or OFE, in which case the envelope probability might be appropriately increased.

The following steps can assist in the determination of combined occurrences required to determine the minimum applicable HQ Rating shown in FIGURE 12:

- (1) Determine an occurrence probability value (see FIGURES 9 & 10) considering the combination of factors for Flight Envelope (Xe), Atmospheric Disturbance (Xa), and EFCs failure state (Xc) (after making necessary adjustments for interrelationships, as noted above).
- (2) Ignore events whose occurrences are less frequent than 10⁻⁹.
- (3) For those combinational conditions occurring more frequently than 10⁻⁹, determine a "Flight Condition" value using only the combination values of EFCs Failure State (Xc) and Flight Envelope (Xe). Group this result (Xc-Xe) into a category of either "Probable Flight Condition" (10⁰ - 10⁻⁵) or "Improbable Flight Condition" (10⁻⁵ - 10⁻⁹).
- (4) Select or develop appropriate task(s) from FIGURE 11.
- (5) Using this task(s), determine the minimum applicable HQ Rating shown in FIGURE 12 with the given Flight Envelope and Atmospheric Disturbance, plus "Flight Condition" determined from step (3).

Figure 5 PROBABILITY GUIDELINES FOR COMBINED OCCURRENCE FLIGHT CONDITIONS

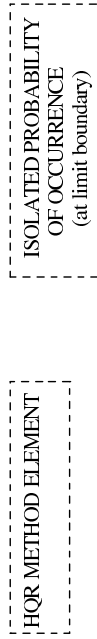

A. FLIGHT ENVELOPE

(NFE)	Normal Flight Envelope: Generally associated with practical, routine operation and/or prescribed conditions, whether all-engine or engine inoperative.	10 ⁰
(OFE)	Operational Flight Envelope: Generally associated with warning onset; outside the normal flight envelope.	10 ³
(LFE)	Limit Flight Envelope: The most outside flight envelope, generally associated with airplane design limits or EFCS protection limits.	10 ⁵

Refer to FIGURES 6 & 7.

Several of the flight parameter values may be necessary in combination in order to assign a given flight envelope. For the more influential flight parameters, such as AOA, speed, and N_z , the flight envelope may be determined by fewer or even one of the parameter values. Since the flight envelopes cover ranges of parameters (e.g., Flaps UP: N_z , $(LFE) = 1.6 - 2.5$), and are not just single point values, the above target probabilities for OFE and LFE might vary slightly depending on expected airplane behavior and assigned task within the range.

B. ATMOSPHERIC DISTURBANCE LEVEL

LIGHT:	Turbulence that momentarily causes slight, erratic changes in altitude and/or attitude (pitch, roll, yaw). Crosswinds up to 10 kts.	10 ⁰
MODERATE:	Turbulence that is similar to light turbulence but of greater intensity. Changes in altitude and/or attitude occur. Usually causes variations in indicated airspeed. Crosswinds up to 25 kts.	10 ³

maximum landing weight, the reduced flap certification may be eligible for a limited flight test program (e.g., stall speed verification, handling characteristics, and qualitative landing demonstration). Further limitations may be imposed by the criteria of Technical Standard Order (TSO) C26c ("Aircraft Wheels and Wheel-Brake Assemblies, with Addendum I," dated May 18, 1984), wheel fusible plug energy limits, quick turnaround considerations, the maximum demonstrated kinetic energy level, wheel spin-up loads, etc.

FIGURE 3-2. EQUIVALENT WEIGHT EXTRAPOLATION

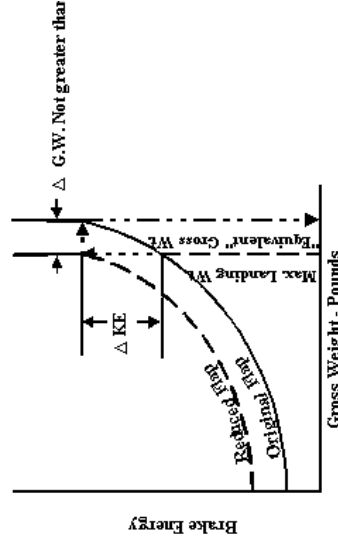

(B) Wind Limits. For takeoff and landing tests, a wind velocity limit of 10 knots (from any direction) or $0.12V_{SI}$ (whichever is lower) at the height of the mean-aerodynamic-chord (MAC), as determined with the airplane in a static ground attitude, has been considered the maximum acceptable. When test wind velocity is to be measured at the wing MAC height, a measurement height of six feet above the ground should be considered as a limit to avoid possible measurement inaccuracies due to surface interference. Because of likely unsteady wind conditions, it is generally considered that takeoff and landing performance data obtained under runway wind conditions greater than 5 knots are likely to be inconsistent and unreliable. If performance data are obtained with winds greater than 5 knots, these data should not necessarily be ignored.

(C) C.G. Limits. A test tolerance of ± 7 percent of the total c.g. range is intended to allow some practical relief for inflight c.g. movement. This relief is only acceptable when the test data general scatter is on both sides of the limiting c.g. or when c.g. correction from test c.g. to limit c.g. is acceptable.

(D) Airspeed Limits. Normally, tests conducted within 3 percent or 3 knots (whichever is the higher) of the desired test speed are considered acceptable.

(E) Thrust Limits. Thrust critical tests, such as minimum control speeds, should be conducted at the highest thrust (power) allowable on the engine given the constraints of temperature and altitude. It is then permitted to calculate further corrections to allow extrapolation of data to cover the entire operating envelope. These thrust corrections are limited to 5 percent of test day thrust, unless a detailed analysis is performed (see Appendix 3 of this AC).

(iii) Because the tolerance values normally are not considered in the airplane design substantiation, it is not the purpose of these tolerances to allow flights at values in excess of those authorized in the type design. If such flights are to be conducted, adequate structural substantiation for the flight conditions should be available. These flights, however, are always conducted under controlled conditions and with the flight test crew's full cognizance of the situation. Examples of such flights are:

(A) Takeoff at greater than maximum takeoff weight for the purpose of reaching a test area at the maximum takeoff weight.

(B) Landing at greater than maximum landing weights during the course of conducting takeoff tests.

(C) Flights to obtain data for future approvals beyond that substantiated for the initial type design.

(iv) The table in Figure 3-3 indicates the cases in which corrections are normally allowed. Any corrections to flight test data should be made by methods that are agreed to by the FAA.

FIGURE 3-3. TEST PARAMETERS THAT NORMALLY CAN BE CORRECTED

Flight Test Condition	Correctable Parameters					
	Wt.	C.G.	Airspeed	Altitude	Power/Thrust	Wind
Airspeed calibration	X	---	---	---	---	---
Stall speeds	X	X	---	---	X	---
Climb performance	X	X	X	X	X	---
Landing performance	X	---	X	X	---	X
Takeoff performance	X	X	---	X	X	X
Accelerate-stop perf.	X	X	---	X	X	X
Minimum control speed	---	---	---	---	X	---
Minimum unstick speed	X	X	X	---	X	---
Buffet boundary	X	X	---	X	---	---

(v) All instrumentation used in the flight test program should be appropriately calibrated and acceptable to the FAA test team.

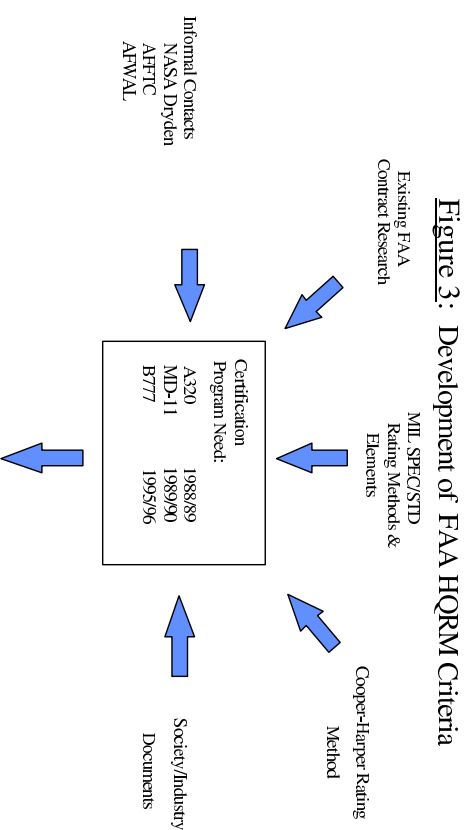

Figure 3: Development of FAA HQRM Criteria

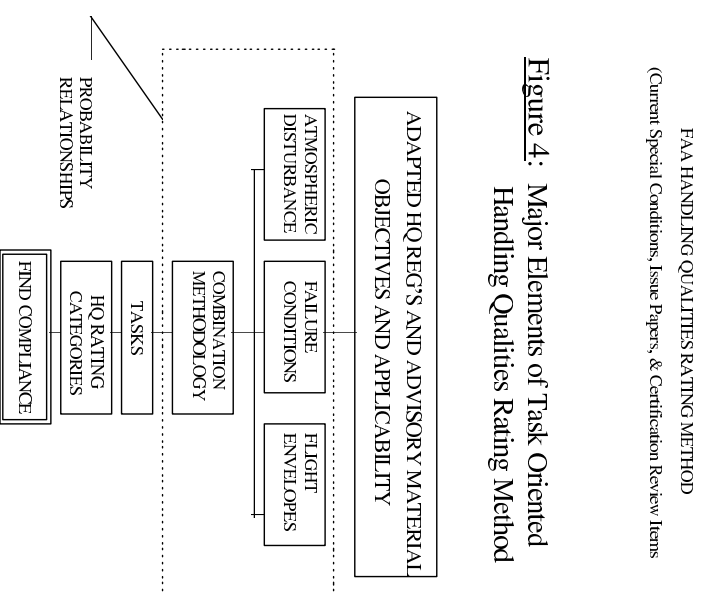

Figure 4: Major Elements of Task Oriented Handling Qualities Rating Method

(4) Section 25.21(f) - Proof of Compliance (Wind Measurement and Corrections). The relationship between the wind measured at one height and the corresponding wind at another height may be obtained by the following equation:

$$V_{W2} = V_{W1} (H_2/H_1)^{1/7}$$

Where: H = Height above the runway surface
 V_{W2} = Wind velocity at H_2
 V_{W1} = Wind velocity at H_1

This equation is presented graphically below. Values of H less than 5 feet should not be used in this relationship.

FIGURE 3-4. WIND PROFILE VARIATION

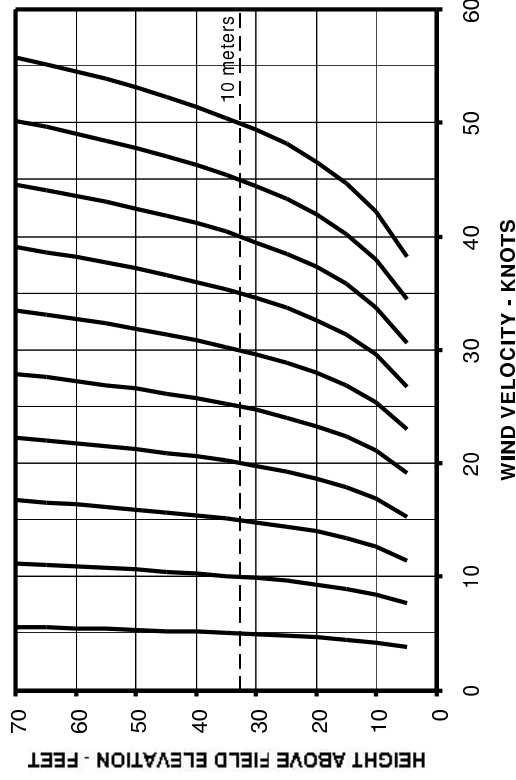

(5) Wind Profile Variation for Test Data. The performance data of airplanes should be obtained in such a manner that the effect of wind on the test data may be determined. The test wind velocity should be corrected from the recorded height above the test surface to the height of the airplane wing mean-aerodynamic-chord. If the wind profile variation is not measured, the variation may be calculated using the equation in paragraph (4) above. The following examples are methods of handling wind profile variation data. Other methods have also been found acceptable.

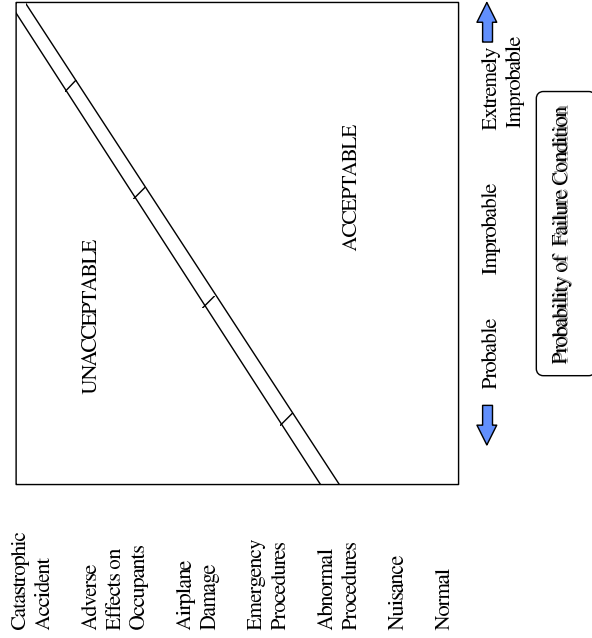

Figure 2: Probability vs. Consequence Graph*

*From AC 25.1309-1A (Sys. Design & Anal.)

Example: Test Data

Given:

- o Height of mean-aerodynamic-chord with airplane on surface 8 ft.
- o Height of wind measurement 6 ft.
- o Measured wind velocity 4.8 kts.

Results:

- o Test wind velocity with airplane 50 ft. above landing surface $4.8(50 + 8)/6)^{1/7} = 6.6$ kts.
- o Test wind velocity with airplane 35 ft. above takeoff surface $4.8(35 + 8)/6)^{1/7} = 6.4$ kts.
- o Test wind velocity with airplane on surface $4.8(8/6)^{1/7} = 5.0$ kts.

(6) Wind Profile Variation for Airplane Flight Manual (AFM) Data. When expanding the data to the AFM conditions, the result should include the effective velocity, at the airplane's wing mean-aerodynamic-chord, which corresponds to the wind condition as measured at 10 meters (32.81 ft.) above the takeoff surface, and corrected for wind factors of § 25.105(d)(1).

Example: Airplane Flight Manual Data

Given:

- o Height of mean-aerodynamic-chord with airplane on surface 8.0 ft.
- o Reported head wind at 10 meters 40.0 kts.
- o Section 25.105(d)(1) wind factor 0.5

Results:

- o Factored wind velocity with airplane 50 ft. above landing surface $(0.5)(40)(50 + 8)/32.81)^{1/7} = 21.7$ kts.
- o Factored wind velocity with airplane 35 ft. above takeoff surface $(0.5)(40)(35 + 8)/32.81)^{1/7} = 20.8$ kts.
- o Factored wind velocity with airplane on surface $(0.5)(40)(8/32.81)^{1/7} = 16.3$ kts.

(7) Airplane Airspeed Variation Due to Wind Profile Variation With

Simultaneous Speed Changes Due to Airplane Dynamic Performance. In the reduction of test data and in the expansion of such data to AFM conditions, the increase or decrease of speed due to the dynamic effect of the forces on the airplane are manifested by only the change in ground speed. These changes in speed (zero wind speed changes) may be

CURRENT REGULATION	BASIC OBJECTIVE	LIKELY DEFICIENCY FOR AIRPLANE WITH FBW MANEUVER DEMAND EFCS
25.171/173/175	Static Long: Stab: 1 lb/6 kts, average	Literal noncompliance: Airplane has short-term path stability.
25.171/177	Stat. Lat-Dir Stab: F _z /Beta > 0	Literal noncompliance for roll-rate command EFCS, when airplane in steady sideslip.
25.671(c)(2)	Control Systems, General: Continued safe flight and landing after combination of failures not shown to be extremely improbable.	Proper objective, but no structured approach showing compliance for matrix of EFCS failure modes and flight conditions.
25.672(c)(1)(3)	Various HQ requirements for failure of stability augmentation/power-operated systems.	<ul style="list-style-type: none"> • Deals only with single failures (e.g., Yaw Damper-only technology) • Presumes controllability and maneuverability requirements can be maintained, yet trim, stability, and stall characteristics can be impaired.
25.1309(b)(1)	Occurrence of any failure condition which would prevent continued safe flight and landing is extremely improbable	<ul style="list-style-type: none"> • Applies to systems, but has indirect relation to flight characteristics evaluation-clarification needed • Differences between U.S. and European airworthiness interpretations,

Figure 1: Airworthiness HQ Regulations Impacted/Outpaced by Technology.

- (5) Figure 9 presents the method for combining the various flight condition parameter probabilities that will, in turn, be used to determine the minimum handling qualities rating. This method is shown in a graphical format in Figure 10.
- (6) The HQRM is to be used in a task-oriented environment to evaluate airplane handling qualities while performing typical static and dynamic maneuvers. A sample list of such tasks is presented in Figure 11.
- (7) Figure 12 shows a table of the minimum FAA handling qualities rating for a given flight condition, defined as a combination of the flight envelope conditions and the level of atmospheric disturbance, relative to the probability of the failure condition being evaluated.

generalized either as speed increments or speed ratios. The changes in airspeed due to wind profile are superimposed on these speed changes.

Example: Takeoff Test Data

- Given:
- o True airspeed at liftoff, V_{LOF} 144 kts.
 - o True airspeed at 35 ft. above takeoff surface 147 kts.
 - o Test wind at liftoff 5.0 kts.
 - o Test wind with airplane 35 ft. above takeoff surface 6.4 kts.

Results:

- o Speed change due to airplane dynamic performance, zero wind speed change $(V_{35} - V_{LOF}) = (147 - 6.4) - (144 - 5.0)$ 1.6 kts.

Example: Takeoff--Airplane Flight Manual Data

- Given:
- o Factored wind at liftoff 16.3 kts.
 - o Factored wind with airplane 35 ft. above takeoff surface 20.8 kts.
 - o Zero wind speed change, $(V_{35} - V_{LOF})$ 1.6 kts.
 - o Zero wind speed change, $(V_{LOF} - V_R)$ 0.5 kts.
 - o True airspeed required at 35 ft. 150 kts.

Results:

- o Ground speed required at 35 ft. 150-20.8 = 129.2 kts.
- o Ground speed at liftoff 129.2-1.6 = 127.6 kts.
- o True airspeed at liftoff 127.6+16.3 = 143.9 kts.
- o Ground speed at rotation 127.6-0.5 = 127.1 kts.
- o True airspeed at rotation 127.1+16.3 = 143.4 kts.
- o Airplane flight manual rotation speed, true airspeed 150-0.5-1.6 = 147.9 kts.

NOTE: The indicated airspeed at rotation (V_R), given in the AFM, should be predicated on the required speed at 35 ft. minus the speed increment ($V_{35} - V_R$) assuming no airspeed change due to wind profile (i.e., use the "zero wind speed change" increments shown above). The proper rotation speed, assuming the airplane will gain 4.5 knots due to wind profile, is 143.4 knots. However, if this airspeed increase does not materialize, the airplane will be slow by 4.5 knots at 35 feet. It is therefore more desirable to allow the airplane to attain this 4.5 knots on the ground. Any reduction in field length margin of safety by this increase in V_R is adequately compensated for by the 50 percent wind factor.

This also eliminates a requirement to adjust V_R for wind. However, in calculating the AFM field lengths, the airspeed attained due to wind profile may be included.

APPENDIX 7 - FAA HANDLING QUALITIES RATING METHOD

Example: Landing--Airplane Flight Manual Data

Given:

- | | |
|--|-----------|
| o Factored wind with airplane 50 ft. above landing surface | 21.7 Kts. |
| o Factored wind with airplane on landing surface | 16.3 Kts. |
| o Zero wind speed change for 50 ft. to touchdown ($V_{50} - V_{TD}$) | 4.0 Kts. |
| o True airspeed required at 50 ft. | 130 Kts. |

Results:

- | | |
|------------------------------|-------------------------|
| o Ground speed at 50 ft. | 130-21.7 = 108.3 Kts. |
| o Ground speed at touchdown | 108.3-4.0 = 104.3 Kts. |
| o True airspeed at touchdown | 104.3+16.3 = 120.6 Kts. |

(8) Expansion of Takeoff Data for a Range of Airport Elevations.

- (i) These guidelines are applicable to expanding takeoff data above the altitude at which the basic or verifying tests were obtained.
- (ii) In general, takeoff data may be extrapolated above and below the altitude at which the basic test data was obtained without additional conservatism within certain constraints. The extrapolation limits and constraints for expansion of the measured takeoff performance parameters (e.g., data used to develop $V/V_{\infty} = f(TW)$) to operating altitudes is addressed in sub-paragraph 3a(9)(iii), below. Extrapolation of takeoff performance data may be further limited by engine data extrapolation limits, typically to 3,000 feet above the highest altitude at which engine parameters were evaluated for the pertinent power/thrust setting. (See paragraph 9 of this AC for more information on engine testing and data extrapolation.) Certification testing for operation at airports that are above 8,000 feet should also include functional tests of the cabin pressurization system in accordance with paragraph 87b(3) of the AC.
- (iii) When the basic takeoff test data are obtained between sea level and approximately 3,000 ft., the maximum allowable extrapolation limits are 6,000 ft. above, and 3,000 ft. below, the test field elevation. If it is desired to extrapolate beyond these limits, when proven data reduction and expansion methods are used, one of the two following procedures may be employed:

(A) Extrapolation of Performance Data for a Range of Altitudes When Verifying Tests are Not Conducted. The approval of performance data for airport elevations beyond the maximum elevation permitted by basic tests may be allowed without conducting verifying tests, if the calculated data include a conservative factor. This conservatism should result in an increase of the calculated takeoff distance at the

a. Explanation. With the advent of transport category airplanes employing electronic flight control systems (EFCS) that provide control augmentation, and sometimes employ limiting systems, the ability to make a literal finding of compliance with many of the stability and control requirements of Part 25 was eroded. As a result the Handling Qualities Rating Method (HQRM) presented in this appendix was developed to provide a pseudo-quantitative means of evaluating airplane flying qualities. The HQRM draws on a matrix of parameters in defining the desired handling characteristics, including atmospheric conditions, flight envelope conditions, pilot task tracking requirements, and probability of occurrence.

(1) Figure 1 presents a list of deficiencies that exist for applying existing regulations to airplanes with maneuver demand electronic flight control systems.

(2) Since the subject airplanes have redundant EFCS capabilities, which generally provide reduced levels of control duplication with progressive failure states, a "failure consequence vs. probability" type of approach is applicable (see Figure 2).

b. Procedures. The HQRM is to be applied as a task-oriented system to be used in the evaluation of airplane handling qualities in accordance with the following procedures.

(1) A probability of occurrence versus effect philosophy is applied in relating the flight test variables to flight envelope characteristics, atmospheric disturbance levels, and probability of a specific flight control failure state. The combined application of these parameters to make a finding of compliance is shown schematically in Figure 4.

(2) It has also become necessary to create a defined set of criteria by which to evaluate the handling qualities of EFCS-equipped airplanes. In an attempt to create a system that can be used in a standardized manner, the handling qualities rating method has been limited to three levels: Satisfactory (SAT), Adequate (ADQ), and Controllable (CON). These pilot ratings are defined and compared with other established rating scales in Figure 5A. Handling qualities must be demonstrated to meet one of these ratings levels for a particular flight condition that will be defined in terms probability of occurrence, flight envelope, and level of atmospheric disturbance (see Figures 5B, C, and D).

(3) Matrices can be formed of measurable flight parameters for the normal, operational, and limit flight envelopes. These are shown in the "spider web" charts for flaps up and flaps down in Figures 6 and 7, respectively.

(4) A description of the pilot ratings (SAT, ADQ, & CON) is presented in Figure 8 along with their equivalent Cooper-Harper and Military Standard ratings for comparison.

[RESERVED]

desired airport elevations by an amount equal to zero percent for the highest airport elevation approved on the results of the basic tests, and an additional cumulative 2 percent incremental factor for each 1,000 ft. of elevation above the highest airport elevation approved for zero percent conservatism. The 2 percent incremental factor should have a straight line variation with altitude. When performance data are calculated for the effects of altitude under this procedure, the following provisions are applicable:

- (1) Previously established calculation procedures should be used, taking into account all known variables.
- (2) The calibrated installed engine power for the pertinent speed and altitude ranges should be used.
- (3) The brake kinetic energy limits established by airplane ground tests should not be exceeded.

(B) Extrapolation of Performance Data When Verifying Tests Are Conducted.

- (1) If data approval is desired for a greater range of airport elevations, the performance may be calculated from the basic test data up to the maximum airport elevation, provided verifying tests are conducted at appropriate elevations to substantiate the validity of the calculations. The actual airplane performance data from the verifying tests should correspond closely to the calculated performance values.
 - (2) For the verifying tests, it has been found that normally three takeoffs at maximum weights for the elevations tested will provide adequate verification.
 - (3) If verifying tests substantiate the expanded takeoff data, the data may be further expanded up to 6,000 ft. above the altitude at which the verifying tests were conducted. At altitudes higher than 6,000 ft. above the verifying test altitude, the 2 percent per 1,000 ft. cumulative factor discussed in paragraph 3a(9)(iii)(A), above, should be applied, starting at zero percent at the verifying test altitude plus 6,000 feet.
- (9) Expansion of Landing Data for a Range of Airport Elevations.
- (i) For turbine powered airplanes without propellers, the landing distance data may be extrapolated to more than 6,000 ft. above the test altitude without the penalty described in paragraph 3a(9), provided the true airspeed effect on the distance is accounted for.
 - (ii) For turbopropeller and reciprocating engine-powered airplanes, the extrapolated performance should include the conservative factor described in paragraph 3a(9). This may not be necessary if it can be shown that the effects of altitude on the

landing performance, as affected by propeller drag, are known from data available for the airplane configuration.

(10) Tailwind Takeoff and Landing.

(i) Wind Velocities of 10 Knots or Less - Approval may be given for performance, controllability, and engine operating characteristics for operations in reported tailwind velocities up to 10 knots, measured at a 10 meter height, without specific flight tests.

(ii) Wind Velocities Greater than 10 Knots.

(A) Performance. It is considered that takeoff, rejected takeoff, and landing distances, measured in tailwind conditions greater than 10 knots, are unreliable for use in determining airplane performance. Wind conditions of such magnitude are generally not sufficiently consistent over the length of the runway or over the time period required to perform the test maneuver. The 150 percent operational tailwind velocity factor, required by §§ 25.105(d)(1) and 25.125(e), affords a satisfactory method for determination of airplane takeoff and landing performance information and limitations up to a limiting tailwind velocity of 15 knots when using a flight test data base obtained under zero wind conditions.

NOTE: The design requirements of § 25.479 (Level landing conditions) also require the effects of increased contact speeds to be investigated if approval for landings with tailwinds greater than 10 knots is desired.

(B) Control Characteristics. Airplane control characteristics should be evaluated under the following conditions with the center of gravity at the aft limit and the test tailwind velocity equal to the proposed limit tailwind factored by 150 percent:

(1) Takeoff. At light weight with maximum approved takeoff flap deflection, both all-engines operating and one-engine inoperative takeoffs should be evaluated.

(2) Landing. Approach and landing at light weight with maximum approved landing flap deflection.

(3) Determination of the increased ground speed effect on gear vibration, shimmy, flight director and/or autopilot Instrument Landing System (ILS) approaches, Ground Proximity Warning Systems (GPWS) sink rate modes, etc.

(4) If engine idle thrust is increased to account for the increased tailwind velocity, ensure that deviations above the glide slope are recoverable.

(C) Weight Limits. In accordance with the requirements of §§ 25.105(d)(1) and 25.125(e), maximum takeoff weight and maximum quick turnaround

25.233(a), and
25.237(a), (b)(1) and (b)(2)

SUBPART D

25.735(f)(2)

Change "0.2 V_{S0} " to "0.2 V_{SRO} ."

Change the KE equation to read: " $KE = 0.0443(WV^2/N)$ "

Change the V definition to read: " $V = V_{REF}/1.3$ " and " $V_{REF} =$ Airplane steady landing approach speed, in knots, at the maximum design landing weight and in the landing configuration at sea level; and"

25.735(g)

Change to read: "The minimum speed rating of each main wheel-brake assembly (that is, the initial speed used in the dynamometer tests) may not be more than the V used in the determination of kinetic energy in accordance with paragraph (f) of this section, assuming..."

25.773(b)(1)(i)

Change "1.6 V_{S1} " to "1.5 V_{SRI} ."

SUBPART E

25.1001(c)(i) and (c)(3)

Change 1.4 V_{S1} to 1.3 V_{SRI} .

SUBPART F

25.1323(c)(1)

Change "1.3 V_{S1} " to "1.23 V_{SRI} ."

25.1323(c)(2)

Change "1.3 V_{S0} " to "1.23 V_{SRO} ."

25.1325(e)

Change "1.3 V_{S0} " to "1.23 V_{SRO} ."

Change "1.8 V_{S1} " to "1.7 V_{SRI} ."

Part 36 (Noise Standards:
Aircraft Type and Airworthiness
Certification)

NOTE: It has been determined that the following is equivalent for the purposes of FAR Part 36 certification.

Appendix C, Sec. C36.9(e)(1)

Change "1.30 V_S + 10 knots" to
" V_{REF} + 10 knots."

FCAA POSITION:

APPLICANT POSITION:

CONCLUSION:

weight should be determined using brake energies and tire speeds, as appropriate, calculated with the limit tailwind velocity factored by 150 percent.

(D) Engine Operating Characteristics. Satisfactory engine operation should be demonstrated at the limit tailwind velocity factored by 150 percent. The demonstrations should include:

(1) Zero groundspeed operation.

(2) Takeoff power setting procedure used for AFM performance (typically completed by approximately 80 knots), both manually and automatically (autothrottle).

(3) Reverse thrust operations.

(E) Airplane Flight Manual. The AFM should contain a statement that the limitation for tailwinds greater than 10 knots reflects the capability of the airplane as evaluated in terms of airworthiness but does not constitute approval for operation in tailwinds exceeding 10 knots.

b. Procedures.

(1) The performance-related flight test procedures are discussed in each of the following paragraphs of this AC:

- 10. Takeoff and Takeoff Speeds
- 11. Accelerate-Stop Distance
- 12. Takeoff Path
- 13. Takeoff Distance and Takeoff Run
- 14. Takeoff Flight Path
- 15. Climb: General
- 16. Landing Climb
- 17. Climb: One Engine Inoperative
- 18. Enroute Flight Path
- 19. Landing

(2) Performance Data for Multiple Flap or Additional Flap Positions. If approval of performance data is requested for flap settings at which no test data is available, the data may be obtained from interpolation of flight data obtained at no less than four flap settings which are within a constant configuration of other lift devices. If the span of flap settings is small and previously obtained data provides sufficient confidence (i.e., the shape of the curves are known and lend themselves to accurate interpolation), data from three flap settings may be acceptable.

(3) Flight Characteristics for Abnormal Configurations (Ref. § 25.671(c)).

(i) For purposes of this AC, an abnormal configuration is an operational configuration that results from any single failure or any combination of failures not shown to be improbable.

(ii) Flight characteristics for abnormal configurations may be determined by test or analysis to assure that the airplane is capable of continued safe flight and landing. Flight tests, if required, should be conducted at the critical conditions of altitude, weight, c.g., and engine thrust associated with the configuration, and at the most critical airspeed between stall warning (see paragraph 29d(2)(ix) of this AC) and the maximum operating airspeed for the configuration.

4-7. [RESERVED]

25.147(a), (a)(2), (c), (d)	Change "1.2 V _{S1} " to "1.13 V _{SRI} "
25.149(c)	Change "1.4 V _{S1} " to "1.3 V _{SRI} "
25.161(b), (c)(1), (c)(2), (c)(3), (d)	Change "1.2 V _S " to "1.13 V _{SR} "
25.161(e)(3)	Change "1.4 V _{S1} " to "1.3 V _{SRI} "
25.175(a)(2), (b)(1), (b)(2), (b)(3), (c)(4)	Change "0.013 V _{SR} ² " to "0.013 V _{SR0} ² "
25.175(b)(2)(ii)	Change "1.4 V _{S1} " to "1.3 V _{SRI} "
25.175(c)	Change "V _{K0} + 1.4 V _{S1} /2" to "(V _{K0} + 1.3 V _{SRI})/2"
25.175(d)	Change speed range to: "...at speeds between V _{sw} and 1.7 V _{SRI} "
25.175(d)(5)	Change speed range to: "...at speeds between V _{sw} and 1.7 V _{SR0} "
25.177(c)	Change "1.4 V _{S0} " to "1.3 V _{SR0} "
25.181(a), (b)	Change "1.2 V _S " to "1.13 V _{SRI} "
25.201(a)(2)	Change "1.2 V _S " to "1.13 V _{SR} "
25.207(c)	Change "1.6 V _{S1} " to "1.5 V _{SRI} " and "V _{S1} " to "V _{SRI} "
25.207(d)	Change "stalling speed" to "reference stall speed"
25.207(e)	Change to read: "When the speed is reduced at rates not exceeding one knot per second, in straight flight with engines idling and at the center-of-gravity position specified in § 25.103(a)(5), stall warning must begin, in each normal configuration, at a speed, V _{sw} , exceeding the reference stall speed by not less than three knots or three percent, whichever is greater. Once initiated, stall warning must continue until the angle of attack is reduced to approximately that at which the stall warning began."
	Insert a new paragraph that reads: "In slow-down turns at 1.5g load factor normal to the flight path and airspeed deceleration rates greater than two knots per second, with the flaps and landing gear in any normal position, the stall warning margin must be sufficient to allow the pilot to prevent stalling (as defined in § 25.201(d)) when recovery is initiated not less than one second after the onset of stall warning."
	Insert a new paragraph that reads: "Stall warning must also be provided in each abnormal configuration of the high lift devices likely to be used in flight following system failures (including all configurations covered by Airplane Flight Manual procedures)."

25.143(g)

Insert a new paragraph that reads: "The maneuvering capabilities in a constant speed coordinated turn at forward center of gravity, as specified in the following table, must be free of stall warning or other characteristics that might interfere with normal maneuvering:

CONFIGURATION	SPEED	MANEUVERING BANK ANGLE IN A COORDINATED TURN	THRUST/POWER SETTING
TAKEOFF	V_2	30°	ASYMMETRIC WAT-LIMITED. ¹
TAKEOFF	$V_2 + XX^2$	40°	ALL-ENGINES-OPERATING CLIMB. ³
ENROUTE	V_{FTO}	40°	ASYMMETRIC WAT-LIMITED. ¹
LANDING	V_{REF}	40°	SYMMETRIC FOR -3° FLIGHT PATH ANGLE

(1) A combination of weight, altitude and temperature (WAT) such that the thrust or power setting produces the minimum climb gradient specified in § 25.121 for the flight condition.

(2) Airspeed approved for all-engines-operating initial climb.

(3) That thrust or power setting which, in the event of failure of the critical engine and without any crew action to adjust the thrust or power of the remaining engines, would result in the thrust or power specified for the takeoff condition at V_2 , or any lesser thrust or power setting that is used for all-engines-operating initial climb procedures."

25.145(a), (a)(1)

Change to read: "It must be possible, at any point between the trim speed prescribed in § 25.103(a)(6) and stall identification (as defined in § 25.201(d)), to pitch the nose downward so that the acceleration to this selected trim speed is prompt with-

(1) The airplane trimmed at the speed prescribed in § 25.103(a)(6);"

25.145(b)(1) - (4)

Change "1.4 V_{SI} " to "1.3 V_{SRI} ."

25.145(b)(1)

Change "40 percent" to "30 percent."

Change "stalling speed" to "reference stall speed."

25.145(b)(6)

Change "1.4 V_{SI} " to "1.3 V_{SRI} ."

Change "1.1 V_{SI} " to " V_{SW} ."

Change "1.7 V_{SI} " to "1.6 V_{SRI} ."

25.145(c)

Change "1.1 V_{SI} " to "1.08 V_{SRI} ."

8. PROPELLER SPEED AND PITCH LIMITS - § 25.33.

a. Explanation. None.

b. Procedures. The tachometers and the airspeed indicating system of the test airplane must have been calibrated in the last six months. With those conditions satisfied, the following should be accomplished:

- (1) Determine that the propeller speeds and pitch settings are safe and satisfactory during all tests that are conducted in the flight test program within the certification limits of the airplane, engine, and propeller. This includes establishing acceptable low pitch (flight idle) blade angles on turbopropeller airplanes and verifying that propeller configurations are satisfactory at V_{MO}/M_{MO} to prevent propeller overspeed.
- (2) Determine that the propeller speeds and pitch settings are safe and satisfactory during all tests that are conducted to satisfy the performance requirements.
- (3) With the propeller governors operative and the propeller controls in full high r.p.m. position, determine that the maximum takeoff power settings do not exceed the rated takeoff r.p.m. of each engine during takeoff and climb at the best rate-of-climb speed.

(4) With the propeller governors made inoperative by mechanical means, maximum power, no-wind, static r.p.m.'s must be determined. On reciprocating engines with the propeller governors operating on the low pitch stop, the engine speeds must not exceed 103 percent of the maximum allowable takeoff r.p.m. On turbopropeller engines, the engine speeds must not exceed the maximum engine speeds allowed by engine and propeller type designs. Note which systems were disabled and how the disablement was done. If maximum takeoff power torque or sea level standard conditions cannot be obtained on the test day, the data must be corrected to these conditions by an acceptable means. A no-wind condition is considered to be a wind of 5 knots or less. The static r.p.m. should be the average obtained with a direct crosswind from the left and a direct crosswind from the right.

(5) If the above determinations are satisfactory, the low-pitch stop setting and also the high-pitch stop setting must be measured. These data may have been obtained from the propeller manufacturer and may be used, provided the pitch stops have not been changed since the manufacturer delivered the propeller. If measured, the blade station should be recorded. These blade angles must be included in the Type Certificate Data Sheet.

Section 2. PERFORMANCE

9. GENERAL - § 25.101

a. Explanation - Engine Behavior. Section 25.101(c) requires that airplane "performance must correspond to the propulsive thrust available under the particular ambient atmospheric conditions, the particular flight conditions..." Therefore, engine parameter evaluations, engine torque, thrust lapse, propeller thrust, and throttle sensitivity, especially with the Electronic Control Unit off (if installed), should be accounted for at all altitudes up to and including the maximum approved takeoff altitude.

b. Procedures. This aspect of the rule may be accomplished by actual flight test, with approved takeoff ratings, at the maximum desired takeoff altitude, or with acceptable parameter variation analysis associated with tests conducted at less than the maximum objective takeoff altitude.

(1) One acceptable method of demonstrating high altitude engine operability and performance is to simulate the maximum operating altitude conditions by overboosting (i.e., using a higher than normal power setting) at a lower altitude.

(2) It is the applicant's responsibility, in conjunction with the engine manufacturer, to define the test plan for the engine parameter evaluation up to the maximum approved takeoff altitude. Supportive data from the engine manufacturer on the same "type or series" of engine may also be included to reduce the amount of testing conducted.

(3) Extrapolation of engine performance data to 3,000 feet above the highest altitude tested (up to the maximum takeoff altitude to be approved) has been accepted, provided the supportive data, including the flight testing accomplished, establishes a consistent baseline.

(4) Detailed guidance for the testing necessary to show compliance with § 25.101(c) may be found in Advisory Circular 25-XX, "Turboprop Operations at High Altitude Airports," dated (to be released).

10. TAKEOFF AND TAKEOFF SPEEDS - §§ 25.105 AND 25.107 (PART 25 AS AMENDED THROUGH AMENDMENT 25-42).

a. Explanation. The primary objective of the takeoff tests required by § 25.107 is to determine the takeoff speed schedule for all takeoff configurations at all weight, altitude, and temperature conditions within the operational limits selected by the applicant. The provisions of § 25.105 are self-evident and are not repeated or amplified in this discussion. Guidance material for unproved runway evaluation is contained in Chapter 8 (paragraph 2.34) of this Advisory Circular (AC).

b. Procedures. Although the following speed definitions are given in terms of calibrated airspeed, the Airplane Flight Manual (AFM) presentations shall be given in terms of indicated airspeed. Attention should be paid to all potential sources of airspeed error, but special consideration should be given to airplanes with electronic instruments in the cockpit that apply electronic filtering to the airspeed data. This filtering, which causes a time delay in the airspeed indication, can be a source of significant systematic error in the presentation of airspeed to the flightcrew. During a normal takeoff acceleration, the airplane will be at a higher speed than is indicated by the cockpit instrument, which can result in longer distances than are presented in the AFM, particularly in the event of a rejected takeoff near the indicated V_L speed. The effects of any time delays caused by electronic filtering, pneumatic system lag, or other sources should be adequately addressed in the AFM speed and distance presentations. Further explanation of airspeed lag, particularly pertaining to airplanes with electronic instruments in the cockpit, and procedures for calibrating the airspeed indicating system (§ 25.1323(b)) are presented in paragraph 1.77 of this AC.

(1) Section 25.107(a)(1) - Engine Failure Speed (V_{EF}). The engine failure speed (V_{EF}) is defined as the calibrated airspeed at which the critical engine is assumed to fail and must be selected by the

25.107(c)(3)

25.107(g)

NOTE: Unless AOA protection system (stall warning and stall identification) production tolerances are acceptably small, so as to produce insignificant changes in performance determinations, the flight test settings for stall warning and stall identification should be set at the low AOA tolerance limit; high AOA tolerance limits should be used for characteristics evaluations.

25.111(a)

25.119(b)

25.121(c)

25.121(d)

25.121(d)(3)

25.121(d)(4)

25.125(a)(2)

Insert a new paragraph that reads: "A speed that provides the maneuvering capability specified in § 25.143(g)."

Insert a new paragraph that reads: " $V_{Y_{10}}$, in terms of calibrated airspeed, must be selected by the applicant to provide at least the gradient of climb required by § 25.121(c), but may not be less than--

(1) 1.18 V_{S0} ; and

(2) A speed that provides the maneuvering capability specified in § 25.143(g)."

Replace "a speed is reached at which compliance with § 25.121(c) is shown" with " $V_{Y_{10}}$ is reached."

Change to read: "A climb speed of not more than $V_{Y_{10}}$."

Change to read: "...for four engine airplanes, at $V_{Y_{10}}$ and with--

Change to read: "In a configuration corresponding to the normal all-engines-operating procedure in which V_{S0} for this configuration does not exceed 110 percent of the V_{S0} for the related all-engines-operating landing configuration, the steady gradient of climb may not be less than 2.1 percent for two-engine airplanes, 2.4 percent for three-engine airplanes, and 2.7 percent for four-engine airplanes, with --"

Change to read: "...but not more than 1.4 V_{S0} ; and"

Add new paragraph as follows: "Landing gear retracted."

Change to read: "A stabilized approach, with a calibrated airspeed of not less than V_{KEH} , must be maintained down to the 50 foot height. V_{KEH} may not be less than--

(i) 1.23 V_{S0} ; and

(ii) V_{KEA} , established under § 25.149(f); and

(iii) A speed that provides the maneuvering capability specified in § 25.143(g)."

attack (e.g., a stick pusher), V_{CLMAX} may not be less than the speed existing at the instant the device operates;

n_{zw} = Load factor normal to the flight path at

V_{CLMAX} ;

W = Airplane gross weight;

S = Aerodynamic reference wing area; and

q = Dynamic pressure.

V_{CLMAX} is determined with:

25.103(a)(1)

Change to read: "Engines idling, or, if that resultant thrust causes an appreciable decrease in stall speed, not more than zero thrust at the stall speed."

25.103(a)(2)

Change to read: "Propeller pitch controls (if applicable) in the takeoff position;"

25.103(a)(3)

Insert a new paragraph that reads: "The airplane in other respects (such as flaps and landing gear) in the condition existing in the test or performance standard in which V_{SR} is being used;"

25.103(a)(4)

Renumbering of the old § 25.103(a)(3) and change " V_S " to " V_{SR} ."

25.103(a)(5)

Change to read: "The center of gravity position that results in the highest value of reference stall speed; and"

25.103(a)(6)

Insert a new paragraph that reads: "The airplane trimmed for straight flight at a speed selected by the applicant, but not less than 1.13 V_{SR} and not greater than 1.30 V_{SR} ."

25.103(b)

Change to read: "Starting from the stabilized trim condition, apply elevator control to decelerate the airplane so that the speed reduction does not exceed one knot per second."

25.103(b)(1)

Remove this paragraph.

25.103(b)(2)

Remove this paragraph.

25.103(c)

Insert a new paragraph that reads: "In addition to the requirements of paragraph (a) of this section, when a device that abruptly pushes the nose down at a selected angle of attack (e.g., a stick pusher) is installed, the reference stall speed, V_{SR} , may not be less than 2 knots or 2 percent, whichever is greater, above the speed at which the device operates."

25.107(b)(1)

Change " $1.2 V_S$ " to " $1.13 V_{SR}$."

25.107(b)(2)

Change " $1.15 V_S$ " to " $1.08 V_{SR}$."

applicant, V_{EF} cannot be less than the ground minimum control speed (V_{MCR}) as described in §§ 25.149(e) and 25.107(a)(1).

* (2) Section 25.107(a)(2) - V_I . V_I may not be less than V_{EF} plus the speed gained with the critical engine inoperative during the time interval between V_{EF} and the instant at which the pilot takes action after recognizing the engine failure (with the proviso that the time interval may not be less than one second). This action is indicated by pilot initiation of the first action to stop the airplane, such as brakes, throttles, spoilers, etc., during accelerate-stop tests, or by the first control input during V_{MCR} testing. The applicant may choose the sequence of pilot actions. Refer to paragraph 11 of this AC, addressing § 25.109, for a more complete description of rejected takeoff transition procedures and associated time delays. If it becomes evident in expanding the takeoff data for presentation in the AFM that excessive variation in V_I exists due to the many performance variables involved (variations of ± 1.5 knots or ± 100 ft. have been found acceptable), then measures must be taken to reduce the variability displayed in the AFM presentation. Examples of such measures are field length factors, or increments, and multiple web charts (accelerate-go/stop, V_I/V_R) for a particular configuration.

(3) Section 25.107(b) - Minimum Takeoff Safety Speed (V_{MIN}).

(i) V_{AMIN} , in terms of calibrated airspeed, cannot be less than:

(A) 1.1 times the V_{MCA} defined in § 25.149.

(B) 1.2 times V_S for two-engine and three-engine turbopropeller and reciprocating engine-powered airplanes and for all turbojet airplanes that do not have provisions for obtaining significant reduction in the one-engine inoperative power-on stalling speed (i.e., boundary layer control, blown flaps, etc.). The value of V_S to be used in determining V_{AMIN} is the stall speed in the applicable takeoff configuration, landing gear retracted, except for those airplanes with a fixed landing gear or for gear-down dispatch.

(ii) V_{AMIN} may be reduced to 1.15 times V_S for turbopropeller and reciprocating engine-powered airplanes with more than three engines, and turbojet powered airplanes with adequate provisions for obtaining significant power-on stall speed reduction through the use of such things as boundary layer control, blown flaps, etc.

(iii) For propeller-driven airplanes, the difference between the two margins, based upon the number of engines installed on the airplane, is because the application of power ordinarily reduces the stalling speed appreciably. In the case of the two-engine propeller-driven airplane, at least half of this reduction is eliminated by the failure of an engine. The difference in the required factors therefore provides approximately the same margin over the actual stalling speed under the power-on conditions that are obtained after the loss of an engine, no matter what the number of engines (in excess of one) may be. Unlike the propeller-driven airplane, the turbojet/turbofan-powered airplane does not show any appreciable difference between the power-on and power-off stalling speed. This is due to the absence of the propeller, which ordinarily induces a slipstream with the application of power causing the wing to retain its lift to a speed lower than the power-off stalling speed. The applicant's selection of the two speeds specified will influence the nature of the testing required in establishing the takeoff flight path.

(4) Section 25.107(c) - Takeoff Safety Speed (V_2). V_2 is the calibrated airspeed that is attained at or before the airplane reaches a height of 35 ft. above the takeoff surface after an engine failure at V_{EF} using an established rotation speed (V_R). During the takeoff speeds demonstration, V_2 should be continued to an altitude sufficient to assure stable conditions beyond the 35-ft height. V_2 cannot be less than V_{AMIN} . In addition, V_2 cannot be less than the lift-off speed, V_{LOF} , as defined in § 25.107(f). In accordance with § 25.107(c), V_2 in terms of calibrated airspeed "...may not be less than V_R plus the speed increment attained before reaching a height of 35 feet above the takeoff surface." Section 25.111(c)(2) stipulates that the airplane must reach V_2 before it is 35 feet above the takeoff surface and continue at a speed not less than V_2 until it is 400 feet above the takeoff surface. These requirements were first expressed in SR-422A, paragraphs 4T.11-4(b)(4) and (c)(3) and 4T.116(c). The intent of these requirements is discussed in the

preamble to SR-422A, which states, in part, "For these reasons, this regulation permits the airplane to lift off the ground at a speed lower than the V_2 speed." The concern that the regulation change was addressing was the overshoot of V_2 after liftoff when it was required that the airplane attain V_2 on, or near, the ground. It was therefore the intent of the regulation to allow an acceleration to V_2 after liftoff but not to allow a decrease in the field length required to attain a height of 35 feet above the takeoff surface by attaining a speed greater than V_2 under low drag ground conditions, and using the excess kinetic energy to attain the 35 foot height.

(i) In the case of turbojet powered airplanes, when the bulk of the one-engine-inoperative data have been determined with idle cuts, V_2 and its relationship to V_{SR} should be substantiated by a limited number of fuel cuts at V_{FE} . For derivative programs not involving a new or modified engine type (i.e., a modification that would affect thrust decay characteristics), fuel cuts are unnecessary if thrust decay characteristics have been adequately substantiated.

(ii) For propeller-driven airplanes, the use of fuel cuts can be more important in order to ensure that the takeoff speeds and distances are obtained with the critical engine's propeller attaining the position it would during a sudden engine failure. The number of tests that should be conducted using fuel cuts, if any, depends on the correlation obtained with the idle cut data and substantiation that the data analysis methodology adequately models the effects of a sudden engine failure.

(5) Section 25.107(d) – Minimum Unstick Speed (V_{MU}).

(i) An applicant should comply with § 25.107(d) by conducting minimum unstick speed (V_{MU}) determination tests with all engines operating and with one engine inoperative. If a stick pusher is installed, it should normally be active and set to the minimum angle of attack side of its rigging tolerance band. If desired, artificial stall warning systems may be disabled for this demonstration. (See paragraph (vi) below for further discussion regarding the setting of stick pusher and stall warning systems during V_{MU} testing.) During this demonstration, the takeoff should be continued until the airplane is out of ground effect. The airplane pitch attitude should not be decreased after liftoff.

(ii) In lieu of conducting actual one-engine-inoperative V_{MU} tests, the applicant may conduct all-engines-operating V_{MU} tests that simulate and account for all pertinent factors that would be associated with an actual one-engine-inoperative V_{MU} test. To account fully for pertinent factors, it may be necessary to adjust the resulting V_{MU} test values analytically. The factors to be accounted for must at least include the following:

- (A) Thrust/weight ratio for the one-engine-inoperative range.
- (B) Controllability (may be related to one-engine-inoperative free air tests, such as V_S , V_{MC_A} , etc.).
- (C) Increased drag due to lateral/directional control systems.
- (D) Reduced lift due to devices such as wing spoilers used for lateral control.
- (E) Adverse effects of any other systems or devices on control, drag, or lift.

(iii) The number of V_{MU} tests required may be minimized by testing only the critical all-engines-operating and one-engine-inoperative thrust/weight ratios, provided that the V_{MU} speeds determined at these critical conditions are used for the range of thrust/weights appropriate to the all-engines-operating and one-engine-inoperative configurations. The critical thrust/weight is established by correcting to the V_{MU} speed, the thrust that results in the airplane achieving its limiting one-engine-inoperative climb gradient at the normally scheduled speed and in the appropriate configuration.

(iv) Amendment 25-42, effective March 1, 1978, revised §§ 25.107(d) and 25.107(e)(1)(v) in order to permit the one-engine-inoperative V_{MU} to be determined by all-engines-

allowable values defined as a multiple of the $V_{S_{min}}$ stall speed. Consequently, the 1-g stall Issue Papers have applied reduced operating speed factors for determining the minimum operating speeds in order to compensate for the 1-g stall speeds being higher than $V_{S_{min}}$ speeds. The net result was little or no change in operating speeds for airplanes with aerodynamic stall, thus leading to a finding of equivalent safety.

FAA POSITION:

The following constitutes the FAA Equivalent Safety Finding for the Generic Model XYZ airplane:

CER 14 Reference

Part 1 (Definitions and abbreviations)

1.1

Equivalent Interpretations for Generic Model XYZ

Add the following new definitions:

“*Final takeoff speed* means the speed of the airplane that exists at the end of the takeoff path in the en route configuration with one engine inoperative.”

“*Reference landing speed* means the speed of the airplane, in a specified landing configuration, at the point where it descends through the landing screen height in the determination of the landing distance for manual landings.”

Add the following new abbreviations:

“ V_{fno} means final takeoff speed.”

“ V_{ref} means reference landing speed.”

“ V_{SR} means reference stall speed.”

“ V_{SR0} means reference stall speed in the landing configuration.”

“ V_{SR1} means reference stall speed in a specific configuration.”

“ V_{sw} means speed at which onset of natural or artificial stall warning occurs.”

Part 25 (Airworthiness Standards: Transport Category Airplanes)

25.103(a)

Change to read: “The reference stall speed, V_{SR} , is a calibrated airspeed defined by the applicant. V_{SR} may not be less than a 1-g stall speed. V_{SR} is expressed as:

$$V_{SR} \geq \frac{V_{C_{MAX}}}{\sqrt{n_s}}$$

where—

$V_{C_{MAX}}$

= Calibrated airspeed obtained when the load factor-corrected lift coefficient ($\frac{n_{stall} W}{qS}$) is first a

maximum during the maneuver prescribed in paragraph (c) of this section. In addition, when the maneuver is limited by a device that abruptly pushes the nose down at a selected angle of

ISSUE PAPER

PROJECT: Generic Airplane Company

ANM-110-XXX

ITEM:

STAGE:

REG.REF.: § 1.2 (Abbreviations and symbols); All FAR 25 sections, except structural, dealing with stall speeds and related factors; and FAR 36 Noise standards (Appendix C)

DATE:
Generic IP Revised 11/14/97

NATIONAL

ISSUE STATUS: OPEN

POLICY REF.: NONE

SUBJECT: Use of 1-g Stall Speeds Instead of Minimum Speed in the Stall as a Basis for Determining Compliance

BRANCH ACTION: -160x

COMPLIANCE
TARGET: Pre-TC

EQUIVALENT SAFETY FINDING

STATEMENT OF ISSUE:

Generic may elect to use 1-g stall speeds, rather than "traditional" V_{SMIN} stall speeds, as the reference datum for regulatory compliance. Use of 1-g stall speeds as the performance basis requires changes to related abbreviations and symbols in FAR 1, and speeds based on multiples of stall speed presented in Subparts B, D, E, and F of FAR 25, and FAR 36. Speed factors in Subpart C of FAR 25 remain unchanged, since they have been applied historically to 1-g stall speeds, not V_{SMIN} stall speeds.

If Generic elects to use the traditional V_{SMIN} to define stall speed, the FAA will require the ratio of $V_{SMIN}/V_{S1.G}$ to be greater than or equal to 0.94 to ensure that application of the subsequent operating speed margins will provide adequate protection from stall. With this additional limitation on allowable V_{SMIN} , all associated operating speed margins will be calculated based on current FAR 25 requirements (e.g., $V_{MIN} = 1.2V_{SMIN}$).

BACKGROUND:

An equivalent safety finding for the use of 1-g stall speeds, instead of the minimum speeds obtained in the stalling maneuver, as the basis for showing compliance with certain FAR 25 performance, and FAR 36 noise requirements, was established for several past type certification projects. Pilot objectivity on stall identification has become a key factor in decisions on flying technique, especially where deterrent buffet or excessively low load factors are developed during stalls to V_{SMIN} . To avoid these problems, and to become consistent with recent certification practice, the application of 1-g stall speed criteria is being expanded to include most areas of the transport-related regulations that use stall speed as a factor.

The 1-g stall requirements were derived to provide a more realistic and consistent basis for the definition of stall speed as the minimum speed at which wing lift alone can support the weight of the airplane in level flight. Service history has not indicated a safety related deficiency in existing operating speeds that typically have their minimum

operating tests at the thrust/weight ratio corresponding to the one-engine-inoperative condition. As revised, § 25.107(d) specifies that V_{MU} must be selected for the range of thrust/weight ratios to be certificated, rather than for the all-engines-operating and one-engine-inoperative conditions as was previously required.

In determining the all-engines-operating thrust/weight ratio that corresponds to the one-engine-inoperative condition, consideration should be given to trim and control drag differences between the two configurations in addition to the effect of the number of engines operating. The minimum thrust/weight ratio to be certificated is established by correcting, to the V_{MU} speed, the thrust that results in the airplane achieving its limiting engine-out climb gradient in the appropriate configuration and at the normally scheduled speed.

(v) To conduct the V_{MU} tests, rotate the airplane as necessary to achieve the V_{MU} attitude. It is acceptable to use some additional nose-up trim over the normal trim setting during V_{MU} demonstrations. If additional nose-up trim is required, the additional considerations of paragraph (vii), below, apply. V_{MU} is the speed at which the weight of the airplane is completely supported by aerodynamic lift and thrust forces. Some judgment may be necessary on airplanes that have tilting main landing gear bogies. Determining the liftoff point from gear loads and wheel speeds has been found acceptable in past programs. After liftoff, the airplane should be flown out of ground effect. During liftoff and the subsequent climbout, the airplane should be fully controllable.

(vi) V_{MU} testing is a maximum performance flight test maneuver, and liftoff may occur very near the angle of attack for maximum lift coefficient. Also, even though pitch attitude may be held fairly constant during the maneuver, environmental conditions and transiting through ground effect may result in consequential changes in angle of attack. It is permissible to lift off at a speed that is below the normal stall warning speed, provided no more than light buffet is encountered. An artificial stall warning system (e.g., a stick shaker) may be disabled during V_{MU} testing, although doing so will require extreme caution and depend upon a thorough knowledge of the airplane's stall characteristics. If the airplane is equipped with a stick pusher, for flight test safety reasons it should normally be active and set to the minimum angle of attack side of its rigging tolerance band. However, depending on the airplane's stall characteristics and the stick pusher design, disabling the pusher or delaying activation of the system until a safe altitude is reached may be the safer course. Again, this decision should be made only with a thorough knowledge of the airplane's stall characteristics combined with a complete understanding of the stick pusher design.

(vii) V_{MU} Testing for Airplanes Having Limited Pitch Control Authority.

(A) For some airplanes with limited pitch control authority, it may not be possible, at forward c.g. and normal trim, to rotate the airplane to a liftoff attitude where the airplane could otherwise perform a clean flyaway at a minimum speed had the required attitude been achieved. This may occur only over a portion of the takeoff weight range in some configurations. When limited pitch control authority is clearly shown to be the case, V_{MU} test conditions may be modified to allow testing aft of the forward c.g. limit and/or with use of more airplane nose-up trim than normal. The V_{MU} data determined with this procedure should be corrected to those values representative of the appropriate forward limit; the variation of V_{MU} with c.g. may be assumed to be like the variation of free air stalling speed with c.g. Although the development of scheduled takeoff speeds may proceed from these corrected V_{MU} data, additional tests are required (see paragraph (B) below) to check that the relaxed V_{MU} criteria have not neglected problems that might arise from operational variations in rotating airplanes with limited pitch control authority.

(B) In the following assurance test, the airplane must demonstrate safe flyaway characteristics.

(L) Minimum speed liftoff should be demonstrated at the critical forward c.g. limit with normal trim. For airplanes with a cutback forward c.g. at heavy weight, two weight/c.g. conditions should be considered. The heavy weight tests should be conducted at maximum structural or maximum sea level climb-limited weight with the associated forward c.g. The full forward c.g. tests should be conducted at the highest associated weight. These tests should be conducted at minimum thrust/weight

for both the simulated one-engine-inoperative test (symmetrical reduced thrust) and the all-engines-operating case.

(2) One acceptable test technique is to hold full nose-up control column as the airplane accelerates. As pitch attitude is achieved to establish the minimum liftoff speed, pitch control may be adjusted to prevent overrotation, but the liftoff attitude should be maintained as the airplane flies off the ground and out of ground effect.

(3) Resulting liftoff speeds do not affect AFM speed schedules if the test proves successful and the resulting liftoff speed is at least 5 knots below the normally scheduled liftoff speed. Adjustments should be made to the scheduled V_R forward e.g. limit, etc., if necessary, to achieve this result.

(4) This minimum 5-knot reduction below the scheduled liftoff speed provides some leeway for operational variations such as mis-trim, e.g. errors, etc. that could further limit the elevator authority. The reduced V_{MU} margins of the minimum liftoff speeds demonstrated in this test, relative to those specified in § 25.107(e)(1)(iv), result from the reduced probability of a pitch control authority-limited airplane getting into a high drag condition due to overrotation.

(viii) V_{MU} Testing for Geometry Limited Airplanes.

(A) For airplanes that are geometry limited, the 110 percent of V_{MU} required by § 25.107(e)(1)(iv) may be reduced to an operationally acceptable value of 108 percent on the basis that equivalent airworthiness is provided for the geometry-limited airplane. For acceptance of the 108 percent of V_{MU} liftoff speed, safeguards protecting the geometry-limited airplane against both overrotation on the ground and in the air must be provided. Also, the airplane should be geometry limited to the extent that a maximum gross weight takeoff with the tail dragging will result in a clean liftoff and fly-away in the all-engines-operating condition. During such a takeoff for the all-engines-operating condition, the resulting distance to the 35 ft. height must not be greater than 105 percent of the normal takeoff distance under similar weight, altitude, and temperature conditions before the 15 percent margin is added. Lastly, the V_{MU} demonstrated must be sound and repeatable. Compliance with these criteria should be formally addressed in a finding of equivalent safety.

(B) The criteria for demonstrating the capability for a clean liftoff and fly-away are as follows:

(1) The airplane's pitch attitude from a speed of 96 percent of the actual liftoff speed must be within 5 percent (in degrees) of the tail-dragging attitude to the point of liftoff.

(2) During the above speed range (96 to 100 percent of the actual liftoff speed), the aft under-surface of the airplane must have achieved actual runway contact. It has been found acceptable in tests for contact to exist approximately 50 percent of the time that the airplane is in this speed range.

(3) Beyond the point of liftoff to a height of 35 ft., the airplane's pitch attitude must not decrease below that at the point of liftoff, or the speed must not increase more than 10 percent.

(4) The airplane shall be at the critical thrust/weight condition, as defined in § 25.107(d), but with all engines operating.

(ix) V_{MU} for a Stretched Version of a Tested Airplane.

(A) It has been considered that the V_{MU} speed represents the aerodynamic potential minimum liftoff speed related to a safe liftoff and fly-away, even though the body contact attitude may

airplanes with systems such as stick pushers would realize a considerable reduction in operating speeds and operating speed margins from stall with the basic 1-g stall speed criteria, the design characteristics of such airplanes and their systems should be evaluated with regard to providing a satisfactory level of safety.

c. For airplanes that have stall defined by a system that provides an abrupt nose down pitch (e.g., a stick pusher) that do not gain a significant increase in wing lift with power on, it may not be feasible to permit full reduction of the operating speed factors as contained in the 1-g stall speed criteria. Other factors such as susceptibility of the wing to stall angle of attack variability due to leading edge contamination should also be investigated before applying the full 1-g stall operating speed reductions to these airplanes. Such investigations may be accomplished by review of analytical data and in conjunction with other certification testing (e.g., windtunnel and icing flight test data could be used to investigate the effects of leading edge contamination). For assistance in determining allowable operating speed factor reductions for these airplanes, the FAA Transport Standards Staff of the Transport Airplane Directorate should be contacted.

prevent achieving the lift coefficient (C_L) for this speed. Such is the case when V_{MU} is determined with body contact, whether or not geometry-limited "credit" is sought. It is therefore concluded that a V_{MU} schedule obtained on one model of an airplane type may be applied to a geometry-limited stretched version of that tested airplane. The 108 percent speed factor of paragraph 10b(5)(viii)(A), above, is only applicable to the stretched version if it was applicable to the tested airplane.

(B) Since the concern for tail strikes is increased with the stretched airplane, the following shall be accomplished, in addition to normal takeoff tests, when applying a shorter body airplane's V_{MU} schedule to the stretched derivative:

(L) Scheduled rotation speeds (V_R) for the stretched airplane should result in at least the required liftoff speed margins above V_{MU} (i.e., 1.05 and 1.10 or 1.08, as applicable) of the shorter body airplane, corrected for the reduced runway pitch attitude capability and revised c.g. range of the stretched airplane.

(Q) At both the forward and aft c.g. limits, and over the thrust-to-weight range for each takeoff flap, the following abuse takeoff tests must be accomplished. The tests described in paragraphs (i) and (ii), below, should be accomplished with not more than occasional, minor (i.e., non-damaging) tail strikes.

(i) All-engines-operating, early rotation abuse tests specified in paragraph 10b(6)(iii)(B), including both the rapid rotations and over-rotations as separate test conditions.

(ii) One-engine-inoperative, early rotation abuse tests specified in paragraph 10b(6)(ii).

(iii) All-engines-operating, moderate rotation rate (i.e., more rapid than normal) takeoff abuse tests, using the scheduled V_R and normal pitch attitude after liftoff. No tail strikes may occur for this condition.

(6) Section 25.107(e) - Rotation Speed (V_R).

(i) The rotation speed, (V_R) in terms of calibrated airspeed, must be selected by the applicant. V_R has a number of constraints that must be observed in order to comply with § 25.107(e):

(A) V_R may not be less than V_I ; however, it can be equal to V_I in some cases.

(B) V_R may not be less than 105 percent of the air minimum control speed (V_{MCA}).

(C) V_R must be a speed that will allow the airplane to reach V_2 at or before reaching a height of 35 ft. above the takeoff surface.

(D) V_R must be a speed that will result in liftoff at a speed not less than 110 percent of V_{MU} (unless geometry limited) for the all-engines-operating condition and not less than 105 percent of the V_{MU} determined at the thrust/weight ratio corresponding to the one-engine-inoperative condition for each set of conditions such as weight, altitude, temperature, and configuration when the airplane is rotated at its maximum practicable rate.

(ii) Early rotation, one-engine-inoperative abuse test.

(A) In showing compliance with § 25.107(e)(3), some guidance relative to the airspeed attained at the 35-ft. height during the associated flight test is necessary. As this requirement dealing with a rotation speed abuse test only specifies an early rotation (V_R-5 knots), it is interpreted that pilot technique is to remain the same as normally used for a one-engine-inoperative condition. With these considerations in mind, it is apparent that the airspeed achieved at the 35-ft. point can be somewhat below

APPENDIX 5

ONE-G STALL COMPLIANCE BASIS

1. APPLICABLE REGULATIONS.

- § 25.103 Stalling speed.
- § 25.201 Stall demonstration.
- § 25.203 Stall characteristics.
- § 25.207 Stall warning.

2. EXPLANATION.

a. Section 25.201 provides the regulatory definition of airplane stall. In particular, § 25.201(d)(1) defines the aerodynamic stall as existing "at an angle of attack measurably greater than that for maximum lift. . . ." The resulting stall speed is defined in § 25.103 as the minimum speed ($V_{S\ MIN}$) attained in the maneuver. For many high speed swept wing transport category airplanes this has resulted in the $V_{S\ MIN}$ stall speed being defined with a flight path load factor considerably less than one, which has led to inconsistent and non-repeatable reference stall speeds. Additionally, because the minimum speed in the maneuver typically occurs near the point at which the airplane spontaneously pitches nose down or where the pilot defines the level of buffet as deterrent, inconsistencies can also be introduced into the definition of the minimum speed by pilot technique and judgment. Since 14 CFR part 25 defines operating speeds as multiples of the $V_{S\ MIN}$ stall speed, the resulting operating speed margins to stall are not representative of the actual lift margin available (i.e., the margin to the speed at which wing lift alone can support the weight of the airplane in 1-g flight); the net result of this inadequate lift margin being inconsistent operating speed margins and maneuvering margins. To remedy this situation, procedures and requirements that are interpreted as being equivalent to the current part 25 stall-related regulations have been developed to define a reference stall speed that exists when the wing is generating maximum usable lift in a 1-g flight condition; this speed is referred to as the 1-g stall speed (V_{S-1g}).

b. Service history has not indicated any safety problem from the use of $V_{S\ MIN}$ stall speeds and their related operating speed factors as currently defined in part 25. A survey of various swept wing transport category airplanes was conducted to establish what load factor existed at $V_{S\ MIN}$; the average load factor was determined to be 0.88, which equates to the $V_{S\ MIN}$ speed being 94 percent of the speed at which the wing lift is equal to the weight of the airplane (i.e., V_{S-1g}). Since service history indicates the existing operating speeds have provided an acceptable level of safety, the existing part 25 operating speed factors were factored by the ratio $V_{S\ MIN}/V_{S-1g} = 0.94$, thereby resulting in essentially the same operating speeds, regardless of the basis used for determining reference stall speeds.

c. The 1-g stall speed criteria has been applied to most type certification projects since the mid-1980s by making a finding of equivalent safety. The FAA Issue Paper process, as described in Order 8110.4A, "Type Certification Process" and Order 8100.5, "Aircraft Certification Directorate Procedures," has been used to document the equivalent safety finding and resolve any airplane-specific issues related to the application of the 1-g stall speed methodology.

3. PROCEDURES.

- a. A generic Issue Paper is presented in this appendix that presents equivalent interpretations of the affected part 25 regulations to enable application of the 1-g stall speed compliance basis.
- b. The following generic Issue Paper contains the necessary equivalent interpretations for making a finding of compliance for airplanes having stall defined by inherent aerodynamic characteristics (e.g., uncommanded nose down pitching moment) or by a system that provides an abrupt nose down pitch (e.g., a stick pusher). Because

the normal scheduled V_2 speed. However, the amount of permissible V_2 speed reduction must be limited to a reasonable amount as described below.

(B) These test criteria are applicable to all unapproved, new, basic model airplanes. They are also applicable to previously approved airplanes when subsequent abuse testing is warranted. However, for those airplanes where the criteria herein are more stringent than that previously applied, consideration will be given to permitting some latitude in the test criteria.

(C) In conducting the flight tests required by § 25.107(e)(3), the test pilot shall use a normal/natural rotation technique as associated with the use of scheduled takeoff speeds for the airplane being tested. Intentional tail or tailskid contact is not considered acceptable. Further, the airspeed attained at the 35-ft. height during this test must not be less than the scheduled V_2 value minus 5 knots. These speed limits should not be considered or used as target V_2 test speeds, but rather are intended to provide an acceptable range of speed departure below the scheduled V_2 value.

(D) In this abuse test, the simulated engine failure should be accomplished sufficiently in advance of the V_R test speed to allow for engine spin-down, unless this would be below the V_{MC} , in which case V_{MC} should govern. The normal one-engine-inoperative takeoff distance may be analytically adjusted to compensate for the effect of the early thrust reduction. Further, in those tests where the airspeed achieved at the 35-ft. height is slightly less than the V_2-5 knots limiting value, it will be permissible, in lieu of conducting the tests again, to analytically adjust the test distance to account for the excessive speed decrement.

(iii) All-engines-operating abuse tests.

(A) Section 25.107(e)(4) states that there must not be a "marked increase" in the scheduled takeoff distance when reasonably expected service variations such as early and excessive rotation and out-of-trim conditions are encountered. This has been interpreted as requiring takeoff tests with all engines operating with:

- (1) An abuse on rotation speed, and
- (2) Out-of-trim conditions, but with rotation at the scheduled V_R speed.

NOTE: The expression "marked increase" in the takeoff distance is defined as any amount in excess of 1 percent of the scheduled takeoff distance. Thus, the abuse tests should not result in field lengths more than 101 percent of the takeoff field lengths calculated in accordance with the applicable requirements of Part 25 for presentation in the AFM.

(B) For the early rotation abuse condition with all engines operating, and at a weight as near as practicable to the maximum sea level standard day takeoff weight limit, it should be shown by test that when the airplane is overrotated at a speed below the scheduled V_R , no "marked increase" in the scheduled AFM field length will result. For this demonstration, the airplane should be rotated at a speed 7 percent or 10 knots, whichever is less, below the scheduled V_R . Tests should be conducted at a rapid rotation rate or should include an overrotation of 2 degrees above normal attitude after liftoff. Tail strikes during this demonstration are acceptable if they are minor and do not result in unsafe conditions.

(C) For reasonably expected out-of-trim conditions with all engines operating and as near as practicable to the maximum weight allowed under sea level standard day conditions, it should be shown that there will not be a "marked increase" in the scheduled AFM takeoff distance when rotation is initiated in a normal manner at the scheduled V_R speed. (See paragraph 21(c)(7)(i) for additional guidance regarding the evaluation of flight characteristics for out-of-trim conditions.) The amount of mistrim should be the maximum mistrim that would not result in a takeoff configuration warning, including taking into account the takeoff configuration warning system-rigging tolerance. It is permissible to accept an analysis

If the force limited V_{MCA} value is high enough to adversely impact the takeoff speed schedule, it can be reduced to an acceptable value by derating takeoff thrust. For example, if the standard day rudder force (F_R) was 140 lbs on an Amendment 25-42 airplane, the maximum allowable asymmetric takeoff thrust would be:

$$F_{\text{max}} = 2600 \frac{150}{140} = 2686 \text{ lbs}$$

Using the same maximum asymmetric thrust available vs airspeed as before:

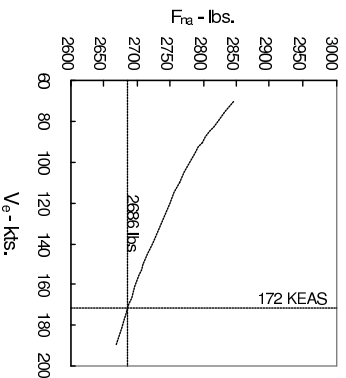

Because of the shallow thrust lapse rate with airspeed, the force limited V_{MCA} for these conditions would be 172 knots, which is obviously unacceptable. To reduce this value back to 80 knots (or any other speed), takeoff thrust must be derated to a level which provides a maximum asymmetric thrust value of F_{max} at the desired V_{MCA} (80 knots in this example). The amount of derate required can be determined from the following plot:

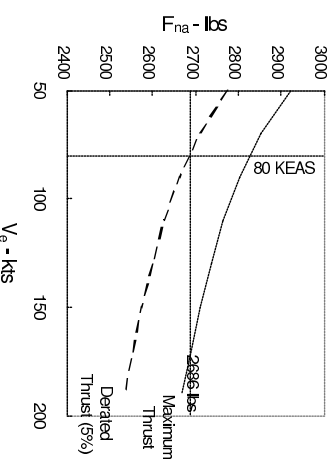

For a given weight and bank angle, rudder pedal force is determined solely by asymmetric thrust; consequently, takeoff thrust must be limited to a value which results in a pedal force no greater than 150 lbs (180 lbs prior to Amendment 25-42).

3. Calculate $W_s \sin \delta$, where W_s is either the average test weight, or the lightest weight scheduled in the AFM, and define standard day rudder force (F_{R_s}) as the intersection of this value of $W_s \sin \delta$ and the curve from step (2). For example:

$$F_{R_s} = 2600 \text{ lbs} \quad V = 1.2V_s \quad W_s = 9000 \text{ lbs}$$

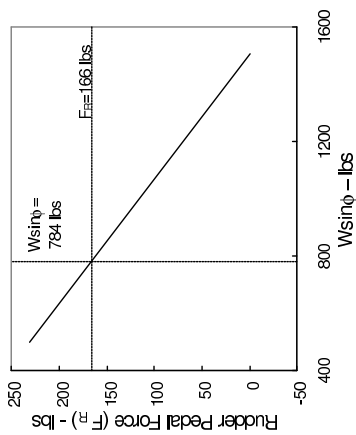

4. Determine the maximum allowable asymmetric thrust from the relationship:

$$F_{R_{max}} = F_{R_s} \cdot \left(\frac{150}{F_{R_s}} \right)^* \cdot \left(\frac{180}{F_{R_s}} \right)^* \text{ prior to Amendment 25-42}$$

Assuming a 180 lb force limit: $F_{R_{max}} = 2600 \cdot \frac{180}{166} = 2820 \text{ lbs}$

5. Plot maximum scheduled AFM thrust vs airspeed, and determine V_{MCA} at the intersection of this curve and $F_{R_{max}}$:

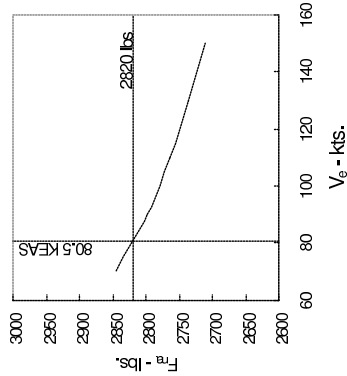

in lieu of actual testing if the analysis shows that the out-of-trim condition would not present unsafe flight characteristics or "marked increase" in the scheduled AFM field lengths.

(iv) Stall Warning During Takeoff Speed Abuse Tests. The presumption is that if an operational pilot was to make an error in takeoff speeds that resulted in an encounter with stall warnings, the likely response would be to aggressively recover to a safe flight condition rather than making a conscious effort to duplicate the AFM takeoff performance data. Therefore, the activation of any stall warning devices, or the occurrence of airframe buffeting during takeoff speed abuse testing, is unacceptable.

(7) Section 25.107(d) - Liftoff Speed (V_{LOF}). The liftoff speed (V_{LOF}) is defined as the calibrated airspeed at which the airplane first becomes airborne (i.e., no contact with the runway). This allows comparison of liftoff speed with the limit speed. V_{LOF} differs from V_{MU} in that V_{MU} is the minimum possible V_{LOF} speed for a given configuration, and depending upon landing gear design. V_{MU} liftoff is shown to be the point where all of the airplane weight is being supported by airplane lift and thrust forces and not any portion by the landing gear. For example, after the V_{MU} speed is reached, a truck tilt actuator may force a front or rear wheel set to be in contact with the runway, even though the flyoff is in progress by virtue of lift being greater than weight.

* 11. ACCELERATE-STOP DISTANCE - § 25.109.

a. Explanation. This section describes test demonstrations and data expansion methods necessary to determine accelerate-stop distances for publication in the FAA-approved Airplane Flight Manual (AFM), as required by § 25.1583(h) (by reference to § 25.1533). Amendment 25-92 revised some aspects of the Part 25 accelerate-stop criteria and added new requirements related to the stopping capability of the airplane as affected by brake wear and wet runways. The changes imparted to the accelerate-stop requirements by Amendment 25-92 are listed below. (For other material related to the use of accelerate-stop distances, see Parts 121 and 135 of the FAR.) *

(1) Section 25.101(f) was added to require accelerate-stop distances to be determined with all the airplane wheel brake assemblies at the fully worn limit of their allowable wear range.

(2) Section 25.105(c)(1) was revised to require takeoff data to be determined for wet, in addition to dry, hard surfaced runways. At the applicant's option, takeoff data may also be determined for wet runways that have grooved or porous friction course surfaces.

(3) Section 25.107(a)(2) was revised to remove the reference to "takeoff decision speed" from the definition of V_1 .

(4) Section 25.109 was revised to add a requirement to determine accelerate-stop distances for wet runways. Additionally, the requirement for the AFM expansion to include two seconds of continued acceleration beyond V_1 , with the operating engines at takeoff thrust, as introduced by Amendment 25-42, was replaced with a distance increment equivalent to two seconds at V_1 . Also, the text of § 25.109(a) was modified to clarify that the accelerate-stop distances must take into account the highest speed reached during the rejected takeoff maneuver, including, as applicable, speeds higher than V_1 .

(5) Section 25.109(f) was added to permit credit for the use of reverse thrust in determining wet runway accelerate-stop distances (subject to the requirements of § 25.109(e)) and to explicitly deny reverse thrust credit for determining dry runway accelerate-stop distances.

(6) Section 25.109(i) was added to require a maximum brake energy accelerate-stop test to be conducted with not more than 10 percent of the allowable brake wear range remaining on each individual wheel-brake assembly.

(7) Section 25.733(f) was added to require the maximum rejected takeoff brake energy absorption capacity rating used during qualification testing to the applicable Technical Standard Order to be based on the fully worn limit of the brake's allowable wear range.

(8) Section 25.1533(a)(3) was revised to add runway surface condition (dry or wet) as a variable that must be accounted for in establishing minimum takeoff distances. Section 25.1533(a)(3) was also revised to allow wet runway takeoff distances on grooved and porous friction course (PFC) runways to be established as additional operating limitations, but approval to use these distances is limited to runways that have been designed, constructed, and maintained in a manner acceptable to the FAA Administrator.

b. **The applicable Federal Aviation Regulations (FAR)** are § 25.109, and the following:

§ 25.101(f)	Airplane configuration and procedures.
§ 25.101(h)	Pilot retarding means time delay allowances.
§ 25.101(i)	Worn brake stopping performance.
§ 25.105	Takeoff configuration and environmental and runway conditions.
§§ 25.107(a)(1) & (2)	Defines V_1 and V_{1F} speeds.
§ 25.735	Brakes.
§ 25.1301	Function and installation.
§ 25.1309	Equipment, systems, and installation.
§ 25.1533	Additional operating limitations – maximum takeoff weights and minimum takeoff distances.

APPENDIX 4

RUDDER PEDAL FORCE-LIMITED AIR MINIMUM CONTROL SPEED

The following analysis presents one method of addressing rudder pedal force limited air minimum control speed. This method is applicable to either jet or propeller driven airplanes. The effect of banking into the operating engine is accounted for, and the method will work with either fixed pitch or constant speed propellers, including the effects of windmilling drag. For rudder deflection limited V_{MCA} , see Appendix 3.

Given the static lateral/directional equations of motion for straight line, unaccelerated flight:

$$\Sigma F_y = 0 \quad C_{Y_{\beta}} \cdot \beta + C_{Y_{\delta_a}} \cdot \delta_a + C_{Y_{\delta_r}} \cdot \delta_r = C_L \cdot \sin\phi \quad (1)$$

$$\Sigma M_x = 0 \quad C_{l_{\beta}} \cdot \beta + C_{l_{\delta_a}} \cdot \delta_a + C_{l_{\delta_r}} \cdot \delta_r = 0 \quad (2)$$

$$\Sigma M_z = 0 \quad C_{n_{\beta}} \cdot \beta + C_{n_{\delta_a}} \cdot \delta_a + C_{n_{\delta_r}} \cdot \delta_r = C_{n_r} \quad (3)$$

For a reversible control system, rudder force versus deflection is:

$$F_R = C_{R1} \cdot q \cdot S_R \cdot \alpha_R \cdot C_{Rn_{\delta_r}} \cdot \delta_r$$

$$\text{and} \quad \delta_R = k_R \cdot \frac{F_R}{V^2}$$

Substituting for δ_R in equations (1) through (3), and solving, results in an identity of the form:

$$F_R = A \cdot F_{ra} - B \cdot W \sin\phi$$

All the airspeed terms canceled, indicating that the engine-out rudder force required for straight flight is not a function of airspeed, but only of asymmetric thrust, weight, and bank angle. If asymmetric thrust did not vary with airspeed, it would be possible to stabilize at any airspeed with the same rudder force. At higher speeds, less rudder deflection would be required (varies inversely with V^2), but the same force would be required (varies directly with V^2). When a force limited V_{MCA} is determined during flight test, the variation in rudder force with airspeed results solely from the change in net thrust with speed, and if an airspeed (thrust) is reached at which the rudder force is 150 lbs, there is no way to correct this force limited V_{MCA} to any other thrust level. Therefore, if V_{MCA} is rudder pedal force limited, takeoff thrust at all flight conditions must be limited to the test value of asymmetric thrust.

In some cases, it is possible to achieve full rudder deflection at the test altitude without reaching a pedal force limit, but with the higher thrust at standard conditions, a force limit would exist. To preclude missing this crossover effect, the following analysis should be performed whenever test day rudder pedal forces are greater than 90 percent of the FAR limit (i.e., 135 lbs after Amendment 25-42; 162 lbs prior to Amendment 25-42).

1. At any convenient airspeed (typically 1.2 V_1 with minimum takeoff flaps), shut down the critical engine, and leave it windmilling (propeller feathered if autofeather is required), apply maximum available power/thrust to the operating engine, and while maintaining constant heading, vary the bank angle from 10° to less than 5° in approximately 2°-3° increments, noting the rudder force at each stabilized bank angle.

2. Plot the rudder force vs $W \sin\phi$ for each of the test points.

- § 25.1583(h) FAA-approved Airplane Flight Manual - operating limitations,
 § 25.1587 FAA-approved Airplane Flight Manual - performance information.

c. Procedures. The following paragraphs provide guidance for accomplishing accelerate-stop flight tests and expanding the resulting data for the determination of AFM performance information.

(1) Accelerate-stop testing. The following guidance is applicable to turbine-powered airplanes with and without propellers. Guidance regarding flight testing applies only to dry runway accelerate-stop distances. Guidance for expanding the flight test data to determine AFM distances applies to both dry and wet runways, unless otherwise noted. Further guidance for determining wet runway accelerate-stop distances is provided in paragraph 11c(4).

(i) In order to establish a distance that would be representative of the distance needed in the event of a rejected takeoff, where the first action to stop the airplane is taken at or below V_1 , a sufficient number of test runs should be conducted for each airplane configuration specified by the applicant. (For intermediate configurations, see paragraph 3 of this advisory circular.)

(ii) The guidance outlined in paragraph 11c(3) describes how to apply the appropriate time delays, as required by § 25.101(h)(3), for the flightcrew to accomplish the rejected takeoff operating procedures.

(iii) Section 25.101(i) states that the accelerate-stop distances must be determined with all the airplane wheel-brake assemblies at the fully worn limit of their allowable wear range. The fully worn limit is defined as the amount of wear allowed before the brake must be removed from the airplane for overhaul. The allowable wear should be defined in terms of a linear dimension in the axial direction, which is typically determined by measuring the wear pin extension.

(A) The only accelerate-stop test that must be conducted at a specific brake wear state is the maximum brake kinetic energy demonstration, which must use brakes that have no more than 10 percent of the allowable brake wear range remaining (see paragraph 11c(2)(iii)). The remainder of the accelerate-stop tests may be conducted with the brakes in any wear state as long as a suitable combination of airplane and dynamometer tests is used to determine the accelerate-stop distances corresponding to fully worn brakes. For example, dynamometer testing may be used to determine whether there is a reduction in brake performance from the wear state used in the airplane tests to a fully worn brake. The airplane test data could then be adjusted analytically for this difference without additional airplane testing.

(B) Either airplane-worn or mechanically-worn brakes (i.e., machined or dynamometer worn) may be used. If mechanically-worn brakes are used, it must be shown that they can be expected to provide similar results to airplane-worn brakes. This comparison can be based on service experience on the test brake or an appropriate equivalent brake, or on dynamometer wear test data when service data are unavailable.

(iv) Section 25.109(f)(1) denies credit for the use of reverse thrust as a decelerating means in determining the accelerate-stop distance for a dry runway. This provision applies to both turbine engine and propeller engine reverse thrust. Credit for the additional deceleration available from reverse thrust is permitted for wet runway accelerate-stop distances, provided the thrust reverser system is shown to be safe, reliable, capable of giving repeatable results, and does not require exceptional skill to control the airplane. (See paragraph 11c(4)(v) for guidance related to obtaining accelerate-stop performance credit for reverse thrust on wet runways.)

(v) The accelerate-stop test runs should be conducted at weight/speed combinations that will provide an even distribution of test conditions over the range of weights, speeds, and brake energies for which takeoff data will be provided in the AFM. The effects of different airport elevations can be simulated at one airport elevation, provided the braking speeds employed are relevant for the range of airplane energies that must be absorbed by the brakes. The limiting brake energy value in the AFM shall not exceed the maximum demonstrated in these tests or the maximum for which the brake has been approved. (See paragraph 11c(2) for further guidance related to tests and analyses for the demonstration of the maximum brake energy absorption capability.)

Substituting $q = \frac{V_e^2}{295}$ and then multiplying through by $\frac{V_e^2 \cdot S}{295}$

$$F_{\text{res}} \cdot \frac{l_e}{b} - K_{\beta} \cdot W_s \cdot \sin\phi_s = \frac{V_e^2}{V_{e_t}^2} \cdot \left[F_{\text{rat}} \cdot \frac{l_e}{b} - K_{\beta} \cdot W_t \cdot \sin\phi_t \right]$$

and finally,

$$V_{MCA_s} = V_{MCA_t} \cdot \left[\frac{F_{\text{res}} \cdot \left(\frac{l_e}{b} - K_{\beta} \cdot W_s \cdot \sin\phi_s \right)}{F_{\text{rat}} \cdot \left(\frac{l_e}{b} - K_{\beta} \cdot W_t \cdot \sin\phi_t \right)} \right]^{\frac{1}{2}} \quad \text{for Turbojets}$$

$$V_{MCA_s} = V_{MCA_t} \cdot \left[\frac{326 \cdot \frac{\text{SHP}_s \cdot \eta_{ts} \cdot \sqrt{\sigma_s} \cdot \frac{l_e}{b} - K_{\beta} \cdot W_s \cdot \sin\phi_s}{V_{MCA_s}}}{326 \cdot \frac{\text{SHP}_t \cdot \eta_{tt} \cdot \sqrt{\sigma_t} \cdot \frac{l_e}{b} - K_{\beta} \cdot W_t \cdot \sin\phi_t}{V_{MCA_t}}} \right]^{\frac{1}{2}} \quad \text{for Turboprops}$$

In the simplified form of the lateral directional equations, K_{β} is $C_{\beta} / C_{Y_{\beta}}$ which is the *directional static margin*. The value of K_{β} typically varies from approximately 0.14 to 0.19, depending on the lateral/directional characteristics of the airplane being tested. As with the graphical method, if K_{β} is determined by flight test, thrust corrections to V_{MCA} are based on an interpolation of flight test defined airframe capability, and there is no limit on the amount of the thrust correction to V_{MCA} . A somewhat conservative default value of 0.20 for K_{β} may be used if flight test data is not available; however, in this case, any thrust extrapolation is limited to 10% of the test day thrust. To assure that corrections for bank angle and weight do not result in standard day V_{MCA} values at or below stall speed, the corrections made by either the graphical or equation method should not result in a V_{MCA} which is based on a $C_L \sin\phi$ that is greater than $C_{L_{\text{MAX}}} \sin^2\phi$.

(vi) The V_1 speeds used in the accelerate-stop tests need not correspond precisely to the AFM values for the test conditions since it may be necessary to increase or decrease the AFM V_1 speed to fully investigate the energy range and weight envelope.

(vii) A total of at least six accelerate-stop flight tests should be conducted. Unless sufficient data are available for the specific airplane type showing how braking performance varies with weight, kinetic energy, lift, drag, ground speed, torque limit, etc., at least two tests should be conducted for each configuration when the same braking coefficient of friction is being claimed for multiple aerodynamic configurations. These tests must be conducted on hard surfaced, dry runways.

(viii) For approval of dispatch capability with anti-skid inoperative, nose wheel brakes or specified main wheel-brake(s) inoperative, autobraking systems, etc., a full set of tests, as in paragraph (vii) above, should normally be conducted. A lesser number of tests may be accepted for "equal or better" demonstrations, to establish small increments or if adequate conservatism is used during testing.

(ix) Either ground or airborne instrumentation should include means to determine the horizontal distance time-history.

(x) The wind speed and direction relative to the test runway should be determined and corrected to a height corresponding to the approximate height of the mean aerodynamic chord. (See paragraph 3 of this advisory circular.)

(xi) The accelerate-stop tests should be conducted in the following configurations:

- (A) Heavy to light weight as required.
- (B) Most critical c.g. position.
- (C) Wing flaps in the takeoff position(s).
- (D) Tire pressure: before taxi and with cold tires, set to the highest value appropriate to the takeoff weight for which approval is being sought.

(E) Engine idle thrust: set at the recommended upper limit for use on the ground or the effect of maximum ground idle thrust may be accounted for in data analyses. For maximum brake energy and fuse plug no-melt tests, data analysis may not be used in place of maximum ground idle thrust.

(xii) Engine thrust should be appropriate to each segment of the rejected takeoff and should include accounting for thrust decay rates (i.e., spindown) for failed or throttled back engines. At the speed that corresponds to the energy level defined for the test demonstration, the stopping sequence is initiated by employing the first acceptable braking means.

(A) Turbojet-powered airplanes. For AFM calculation purposes, the critical engine failure accelerate-stop data may be based on the failed engine spinning down to a windmilling condition. (Note: If, due to the certification basis of the airplane, all-engine-accelerate-stop distances are not being considered, the one-engine-inoperative AFM distances should be based on the critical engine failing to maximum ground idle thrust rather than the windmilling condition.) The thrust from the operative engine(s) should be consistent with a throttle chop to maximum ground idle thrust. For determining the all-engines-operating dry runway accelerate-stop AFM distances, the stopping portion should be based on all engines, producing maximum ground idle thrust (after engine spindown), as noted in paragraph 1(c)(1)(xi)(E). The accelerate-stop tests may be conducted with either concurrent or sequential throttle chops to idle thrust as long as the data are adjusted to take into account pilot reaction time, and any control, system, or braking differences (e.g., electrical or hydraulic/mechanical transients associated with an engine failing to a windmilling condition resulting in reduced braking effectiveness). Test data should also be analytically corrected for any differences between maximum ground idle thrust and the idle thrust level achieved during the test. For the criteria relating to reverse thrust credit for wet runway accelerate-stop distances, see paragraph 11(c)(4)(v).

The following $C_{m\alpha}$ vs $C_L \sin \phi$ plot shows the airframe curve, the standard day engine curve, and the test day curve:

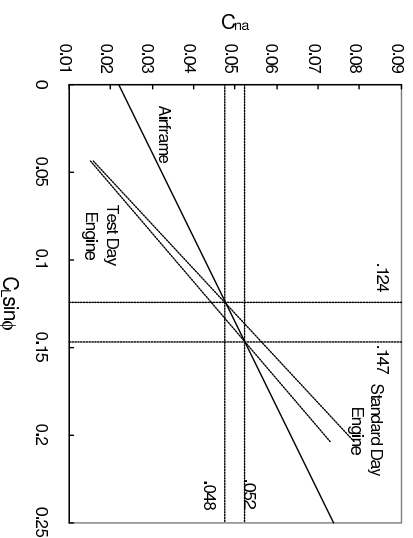

From the airframe/engine curve intersections:

$$C_{m\alpha} = .052 \qquad C_{m\alpha} = .048$$

$$C_L \sin \phi = .147 \qquad C_L \sin \phi = .124$$

$$M_{CA_1} = 82.4 \text{ KTS} \qquad M_{CA_1} = 89.7 \text{ KTS}$$

This is a thrust correction of approximately 8%. If the constant C_m method had been used, the test value of .052 would have applied, and the corresponding M_{CA_1} would have been 85.7 kts, an error of 4 knots (5%) in the non-conservative direction.

Noting that the correction from test day to standard day is along the C_m vs $C_L \sin \phi$ curve, which is a straight line, and denoting the slope of the airframe curve as K_β , the intersection of the standard day thrust line with the airframe curve as $C_{m\alpha}$ and $C_L \sin \phi$, the following equation can be derived:

Given the point-slope form of a straight line,

$$Y_2 - Y_1 = m(X_2 - X_1)$$

Correspondingly,

$$C_{m\alpha} - C_{m\alpha} = K_\beta \cdot (C_L \sin \phi - C_L \sin \phi)$$

$$C_{m\alpha} - K_\beta \cdot C_L \sin \phi = C_{m\alpha} - K_\beta \cdot C_L \sin \phi$$

$$\frac{F_{na} \cdot l_e}{q_s \cdot S \cdot b} - K_\beta \cdot \frac{W \cdot \sin \phi_s}{q_s \cdot S} = \frac{F_{na} \cdot l_e}{q_t \cdot S \cdot b} - K_\beta \cdot \frac{W \cdot \sin \phi_t}{q_t \cdot S}$$

$$V_{MCA} = 89.7 \text{ KEAS}$$

If the airframe data is obtained from flight test, there are no assumptions or simplifications, and the value of V_{MCA} derived from this method includes all the effects of bank angle, sideslip, adverse yaw, angle of attack, etc. Also, since the standard day value of C_{min} will always be less than the test value, no extrapolation is required, and there is no restriction on the value of standard day thrust that may be used.

Equation Method

A single test day value of V_{MCA} can also be corrected to standard conditions (using all the appropriate variables) without using this graphical method, provided either the slope of the C_{min} vs $C_{Lsin\phi}$ relationship is known (from wind tunnel, or analytical estimates), or one is willing to use a default (conservative) value. Thrust extrapolation using slope values not based on flight test is limited to 10% of the test day thrust. The following analysis shows the derivation of this single-point correction equation:

If the test day engine C_{min} curve was added to the previous plot, it would be possible to see how far, and in what direction, the correction from test to standard day was made. Assuming that a single value of V_{MCA} was determined at 3000 feet at a weight of 9000 lbs, a test day engine C_{min} curve could be plotted using the same technique used for the standard day curve, except substituting the 3000 ft thrust values from the engine spec:

V_c	F_{min}	C_{min}	$C_{Lsin\phi}$
70	2.634	0.073	0.204
90	2.589	0.043	0.123
110	2.554	0.029	0.082
130	2.528	0.02	0.059
150	2.510	0.015	0.044

(B) **Turbopropeller-powered airplanes.** For the one-engine-inoperative accelerate-stop distances, the critical engine's propeller should be in the position it would normally assume when an engine fails and the power levers are closed. For dry runway one-engine-inoperative accelerate-stop distances, the high drag ground-idle position of the operating engines' propellers (defined by a pitch setting that results in not less than zero total thrust, i.e., propeller plus jet thrust, at zero airspeed) may be used provided adequate directional control is available on a wet runway and the related operational procedures comply with §§ 25.109(f) and (h). Wet runway controllability may either be demonstrated by using the guidance available in paragraph 11c(4)(v)(F) at the appropriate power level, or adequate control can be assumed to be available at ground idle power if reverse thrust credit is approved for determining the wet runway accelerate-stop distances. For the all-engines-operating accelerate-stop distances on a dry runway, the high drag ground-idle propeller position may be used for all engines (subject to § 25.109(f) and (h)). For the criteria relating to reverse thrust credit for wet runway accelerate-stop distances, see paragraph 11c(4)(v).

(xiii) System transient effects (e.g., engine spin-down, brake pressure ramp-up, etc.) should be determined and properly accounted for in the calculation of AFM accelerate-stop distances (see paragraph 11c(3)(ix)).

(2) **Maximum Brake Energy Testing.** The following paragraphs describe regulatory requirements and acceptable test methods for conducting an accelerate-stop test run to demonstrate the maximum energy absorption capability of the wheel-brakes.

(i) The maximum brake energy accelerate-stop demonstration should be conducted at not less than the maximum takeoff weight and should be preceded by at least a 3-mile taxi with all engines operating at maximum ground idle thrust, including three full stops using normal braking. Following the maximum brake energy stop, it will not be necessary to demonstrate the airplane's ability to taxi.

(ii) Section 25.735(h) requires the rejected takeoff brake kinetic energy capacity rating of each main wheel-brake assembly to be determined at the fully worn limit of its allowable wear range. The calculation of maximum brake energy limited takeoff weights and speeds, for presentation in the AFM performance section, must therefore be based on each airplane main wheel-brake being in the fully worn condition.

(iii) Section 25.109(i) requires a flight test demonstration of the maximum brake kinetic energy accelerate-stop distance to be conducted with not more than 10 percent of the allowable brake wear range remaining on each of the airplane wheel-brakes. The 10 percent allowance on the brake wear state is intended to ease test logistics and increase test safety, not to allow the accelerate-stop distance to be determined with less than fully worn brakes. If the brakes are not in the fully worn state at the beginning of the test, the accelerate-stop distance should be corrected as necessary to represent the stopping capability of fully worn brakes.

(iv) The maximum airplane brake energy allowed for dispatch should not exceed the value for which a satisfactory after-stop condition exists, or the value documented under the applicable Technical Standard Order (TSO) (or an acceptable equivalent), whichever value is less. A satisfactory after-stop condition is defined as one in which fires are confined to tires, wheels, and brakes, such that progressive engulfment of the rest of the airplane would not occur during the time of passenger and crew evacuation. The application of fire fighting means or artificial coolants should not be required for a period of 5 minutes following the stop.

(v) Landings are not an acceptable means for demonstrating the maximum rejected takeoff brake energy. Though permitted in the past, service experience has shown that methods used to predict brake and tire temperature increases that would have occurred during taxi and acceleration, as specified in paragraph 11c(2)(i), were not able to accurately account for the associated energy increments.

(3) **Accelerate-Stop Time Delays.** Section 25.101(h) of the FAR requires allowance for time delays in the execution of procedures. Amendment 25-42 (effective March 1, 1978) amended the airworthiness standards to clarify and standardize the method of applying these time delays to the accelerate-stop transition period. Amendment 25-42 also added the critical engine failure speed, V_{FE} , and clarified the meaning of V_1 with relation to V_{FE} . The preamble to Amendment 25-42 states that " V_1 is determined by adding to V_{FE} (the speed at which the critical engine is assumed to fail) the speed gained with the critical engine inoperative during the time interval between the instant at which the critical engine is failed and the instant at which the test pilot recognizes and reacts

to the engine failure, as indicated by the pilot's application of the first retarding means during accelerate-stop tests. " Thus it can be seen that V_1 is not intended to be at the end of the decision process, but it also includes the time it takes for the pilot to perform the first action to stop the airplane. The purpose of the time delays is to allow sufficient time (and distance) for a pilot, in actual operations, to accomplish the procedures for stopping the airplane. The time delays are not intended to allow extra time for making a decision to stop as the airplane passes through V_1 . Since the typical transport category airplane requires three pilot actions (i.e., brakes-throttles-spoilers) to achieve the final braking configuration, Amendment 25-42 defined a two-second time period, in § 25.109, to account for delays in activating the second and third deceleration devices. Amendment 25-92 (effective March 20, 1998) redefined, and reinterpreted the application of that two-second delay time as a distance increment equivalent to two seconds at V_1 . No credit may be taken for system transient effects (e.g., engine spin-down, brake pressure ramp-up, etc.) in determining this distance. The following paragraphs provide guidance related to the interpretation and application of delay times to show compliance with the accelerate-stop requirements of Amendment 25-92.

(i) Figure 11-1 presents a pictorial representation of the accelerate-stop time delays considered acceptable for compliance with § 25.101(h) as discussed above.

FIGURE 11-1. ACCELERATE-STOP TIME DELAYS

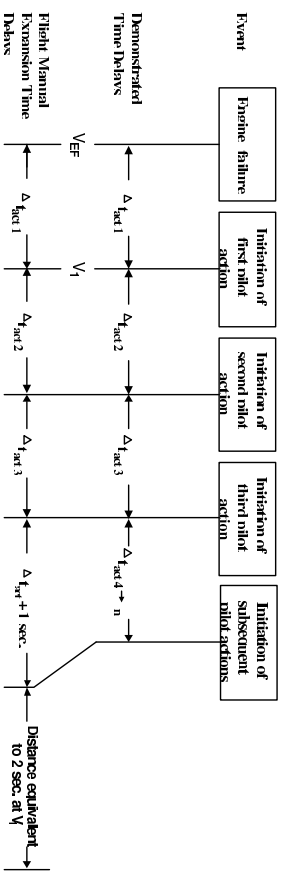

(ii) V_{EF} is the calibrated airspeed selected by the applicant at which the critical engine is assumed to fail. The relationship between V_{EF} and V_1 is defined in § 25.107.

(iii) $\Delta t_{acc,1}$ = the demonstrated time interval between engine failure and initiation of the first pilot action to stop the airplane. This time interval is defined as beginning at the instant the critical engine is failed and ending when the pilot recognizes and reacts to the engine failure, as indicated by the pilot's application of the first retarding means during accelerate-stop tests. A sufficient number of demonstrations should be conducted using both applicant and FAA test pilots to assure that the time increment is representative and repeatable. The pilot's feet should be on the rudder pedals, not the brakes, during the tests. For AFM data expansion purposes, in order to provide a recognition time increment that can be executed consistently in service, this time increment must be equal to the demonstrated time or one second, whichever is greater. If the airplane incorporates an engine failure warning light, the recognition time includes the time increment necessary for the engine to spool down to the point of warning light activation, plus the time increment from light "on" to pilot action indicating recognition of the engine failure.

(iv) $\Delta t_{acc,2}$ = the demonstrated time interval between initiation of the first and second pilot actions to stop the airplane.

(v) $\Delta t_{acc,3}$ = the demonstrated time interval between initiation of the second and third pilot actions to stop the airplane.

(vi) $\Delta t_{acc,4-n}$ = the demonstrated time interval between initiation of the third and fourth (and any subsequent) pilot actions to stop the airplane. For AFM expansion, a one-second reaction time delay to account for in-service variations should be added to the demonstrated time interval between the third and fourth (and any subsequent) pilot actions. If a command is required for another crewmember to initiate an action to stop the

These plots represent the capability of the AIRFRAME to produce yawing moment by a combination of rudder deflection (rudd, in this case) and the sideslip which results from the bank angle. In order to determine the limiting condition for V_{ACA} , it is necessary to know what the APPLED yawing moment is (due to the engine-out moments), and to plot the applied moments on the same plot, in a similar form. It is possible to do this by choosing a gross weight to be used to calculate C_{L_0} and since standard bank angle will be 5°, the only remaining variable in $C_L \sin \phi$ is V_e . By choosing the appropriate values of F_n available versus V_e , a plot of C_{L_0} versus $C_L \sin \phi$ can be made which represents the applied yawing moments. If the weight chosen represents some standard minimum weight, and the available net thrust values represent the maximum allowable thrust scheduled in the AFM, the intersection point of the airframe curve and the engine curve will be the desired standard day values which can be used to calculate V_{ACA} .

V_e	F_{n0}	C_{L_0}	$C_L \sin \phi$
70	2,846	0.079	0.204
90	2,798	0.047	0.123
110	2,764	0.031	0.082
130	2,737	0.022	0.059
150	2,710	0.016	0.044

Plotting both the airframe and engine yawing moment curves on the same graph looks like:

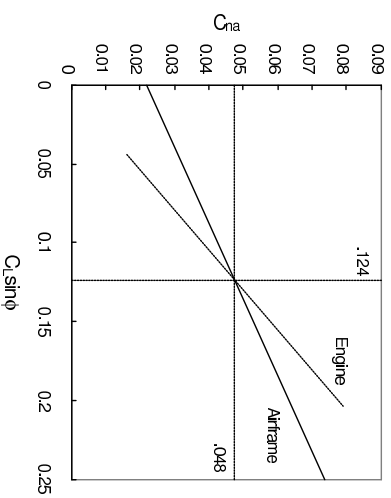

The intersection of the airframe and the engine curve shows values of:

$$C_{L_0} = 0.048 \quad C_L \sin \phi = 0.124$$

Since the engine C_H curve was based on $W = 9000$ lbs, the standard day value of V_{ACA} can be determined from:

$$C_H \sin \phi = 0.124 = \frac{295 \cdot W}{V_e^2 \cdot S}$$

$$V_e = \frac{.1108 \cdot 9000}{0.124}$$

To use this method, instrumentation is necessary for the determination of net thrust/shaft horsepower, and an accurate calibrated airspeed system is required, as well as engine/propeller charts for windmill drag, charts for propeller efficiency, and the ability to measure bank angle to at least a tenth of a degree.

Data obtained using this method with a typical business jet and a large jet transport are shown in the following two graphs:

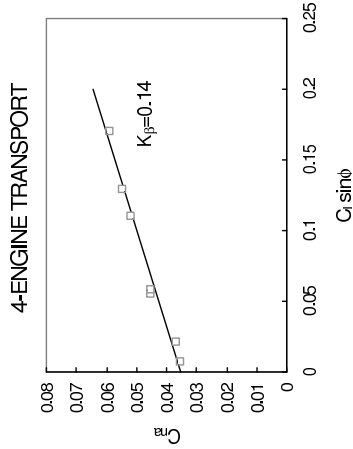
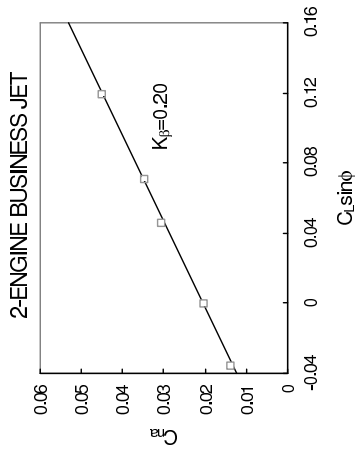

airplane, a two-second delay, in lieu of the one-second delay, should be applied for each action. For automatic deceleration devices that are approved for performance credit for AFM data expansion, established systems actuation times determined during certification testing may be used without the application of the additional time delays required by this paragraph.

(vii) The sequence for initiation of pilot actions may be selected by the applicant, but it must match the sequence established for operation in service, as prescribed by § 25.101(f). If, on occasion, the specified sequence is not achieved during testing, the test need not be repeated; however, sufficient testing must be conducted to establish acceptable values of Δt_{act} .

(viii) Sections 25.109(a)(1)(iv) and (a)(2)(iii) require the one-engine-inoperative and all-engines-operating accelerate-stop distances, respectively, to include a distance increment equivalent to two seconds at V_1 . (Although the requirement for the distance increment equivalent to two seconds at V_1 is explicitly stated in the "dry runway" criteria of § 25.109, it is also applied to the "wet runway" accelerate-stop distances by reference in § 25.109(b).) This distance increment is represented pictorially on the right side of the "Flight Manual Expansion Time Delays" presentation in Figure 11-1, and in the speed versus distance plot of Figure 11-2, below. The two-second time period is only provided as a method to calculate the required distance increment, and is not considered to be a part of the accelerate-stop braking transition sequence. Consequently, no credit for pilot actions, or engine and systems transient responses (e.g., engine spin-down) may be taken during this two-second time period. Similarly, the two-second time period may not be reduced for airplanes incorporating automated systems that decrease the number of pilot actions required to obtain the full braking configuration (e.g., autopilot systems).

FIGURE 11-2. ACCELERATE-STOP SPEED VS. DISTANCE

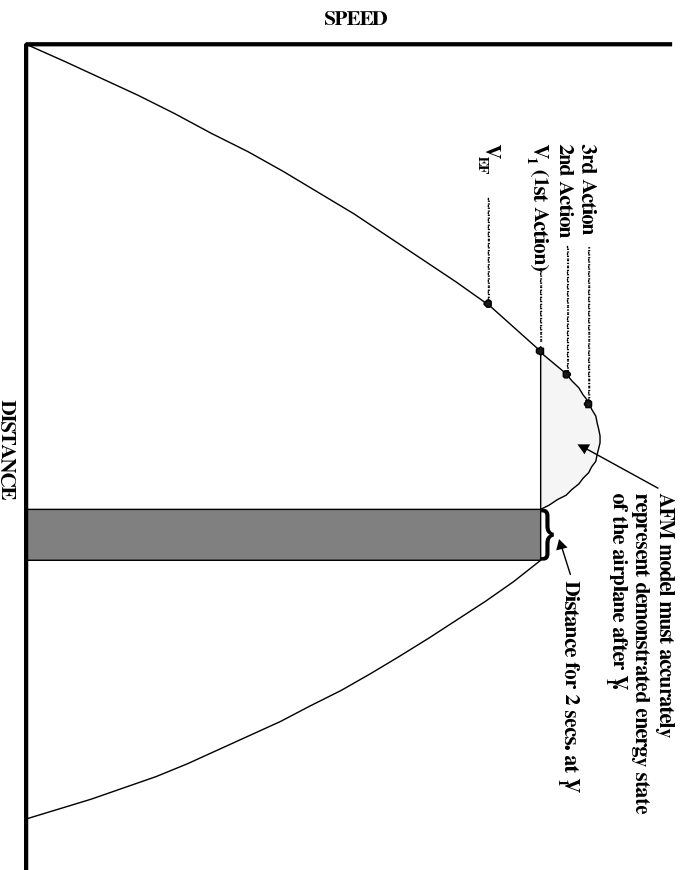

(ix) Any residual acceleration that occurs after V_1 , while the airplane and its systems become stabilized in the braking configuration, must be accounted for in the expansion of accelerate-stop performance data for presentation in the AFM. The effects of system transients, such as engine spin-down, brake pressure ramp-up, spoiler actuation times, etc., should be accounted for in this time period. The area of interest is noted at the top of the graphical representation of the speed versus distance relationship in Figure 11-2.

(x) All-Engine Accelerate-Stop Distance. For the all-engines-operating accelerate-stop distance prescribed by § 25.109(a)(2), apply the demonstrated time intervals, and associated delays, of paragraphs 11(c)(3)(iv) through (vi) after the airplane has accelerated to V_1 .

(xi) The procedures used to determine the accelerate-stop distance must be described in the performance section of the AFM.

(4) Wet Runway Accelerate-Stop Distance. The following guidance is provided for showing compliance with the requirements stated in §§ 25.109(b) through (d) for determining accelerate-stop distances applicable to wet runways. In general, the wet runway accelerate-stop distance is determined in a similar manner to the dry runway accelerate-stop distance. The only differences are in reflecting the reduced stopping force available from the wheel brakes on the wet surface and in provisions for performance credit for the use of reverse thrust as an additional decelerating means. The general method for determining the reduced stopping capability of the wheel brakes on a smooth wet runway is as follows: First, determine the maximum tire-to-ground wet runway braking coefficient of friction versus ground speed from the relationships provided in § 25.109(c)(1). Then, adjust this braking coefficient

If it is assumed that test and standard day V_{MCA} occur at the same angle of attack and bank angle, the asymmetric yawing moment coefficient will be constant, and V_{MCA} can be corrected to standard conditions by the relationship:

$$V_{MCA_S} = V_{MCA_T} \cdot \sqrt{\frac{\rho_{std}}{\rho_{test}}} \quad \text{for Turbojets}$$

$$V_{MCA_S} = V_{MCA_T} \cdot \left[\frac{THP_s \cdot \sqrt{\sigma_s}}{THP_t \cdot \sqrt{\sigma_t}} \right]^{1/3} \quad \text{for Propeller driven}$$

where:

* THP_s = Maximum AFM scheduled Brake/Shaft horsepower multiplied by standard day propeller efficiency;

THP_t = Test day brake/shaft horsepower where V_{MCA} was achieved multiplied by test day propeller efficiency.

$\sqrt{\sigma_s}$ = Atmospheric density ratio at standard conditions.

$\sqrt{\sigma_t}$ = Atmospheric density ratio at test conditions.

*Windmilling SHP is not considered, because the current 14 CFR part 25 takeoff requirements for propeller driven airplanes result in such large performance penalties with a windmilling propeller that all part 25 turboprops to date have had autofeather installed.

Since both net thrust and shaft horsepower vary with speed, use of these equations will require an iterative solution. Because this constant C_D method does not consider the effect on V_{MCA} due to variations in bank angle, weight, sideslip angle, or adverse yaw, its use is limited to corrections of 5% or less in asymmetric net thrust or power.

For corrections beyond 5%, the relationship shown in equation (4) must be used, and enough flight test data must be obtained to define the correlation between $C_{D\alpha}$ and $C_L \sin \phi$.

Graphical Method

In theory these data could be obtained by varying any combination of asymmetric thrust, airspeed, weight, and bank angle that would provide a representative variable set. However, since V_{MCA} and stall speed are nearly coincident for most airplanes, there are some severe constraints on most of the variables. Typically, any reduction in maximum asymmetric thrust will cause V_{MCA} to decrease below stall speed, and any increase in weight will cause stall speed to increase above V_{MCA} ; therefore, the only parameter that can reasonably be varied is bank angle.

To maximize the spread between stall and minimum control speed, V_{MCA} tests are normally done at the lightest possible weight, at the maximum allowable asymmetric thrust (even with a short duration overboost, if the engine manufacturer will agree). At typical test altitudes (2000-3000 feet) and prototype gross weights, it will usually still not be possible to define V_{MCA} with the full 5° bank, because of stall buffet.

To obtain the data necessary for extrapolation to the 5° bank limit, and to maximum asymmetric thrust, testing at three bank angles is required for the definition of the $C_{D\alpha}$ vs $C_L \sin \phi$ relationship. These data should be obtained by shutting down the critical engine (normally the left), setting maximum allowable thrust on the operative engine, and slowing down while maintaining constant heading until full rudder deflection is achieved. The first point, a wings level condition, is easy to set up, and results in a speed well above stall buffet. A second point, at zero sideslip, will be achieved at approximately 2° - 3° bank (flown with a yaw string, or instrumented sideslip vane) and will provide an intermediate speed, still above buffet. The third data point is flown with as much bank angle that can be used without excessive buffeting (no more than would be accepted as the minimum level of stall warning). If necessary, an additional point can be obtained by banking 2° - 3° into the inoperative engine.

to take into account the efficiency of the anti-skid system. (See paragraph 11c(4)(ii) for a definition of anti-skid efficiency.) Next, determine the resulting braking force and adjust this force for the effect of the distribution of the normal load between braked and unbraked wheels at the most adverse center-of-gravity position approved for takeoff, as prescribed by § 25.109(b)(2)(ii). In accordance with § 25.109(b)(2)(i), apply further adjustments, if necessary, to ensure that the resulting stopping force attributed to the wheel brakes on a wet runway never exceeds (i.e., during the entire stop) the wheel brakes stopping force used to determine the dry runway accelerate-to-stop distance (under § 25.109(a)). Neither the dry runway brake torque limit nor the dry runway friction (i.e., anti-skid) limit should be exceeded. Alternative methods of determining the wet runway wheel brakes stopping force may be acceptable as long as that force does not exceed the force determined using the method just described.

(i) **Maximum Tire-to-Ground Braking Coefficient of Friction.** The values specified in § 25.109(c)(1) were derived from data contained in Engineering Sciences Data Unit (ESDU) 71026, "Frictional and Retarding Forces on Aircraft Types - Part II: Estimation of Braking Force." (August 1981). The data in ESDU 71026 is a compilation from many different sources, including the National Aeronautics and Space Administration, the British Ministry of Aviation, and others. ESDU 71026 contains curves of wet runway braking coefficients versus speed for smooth and treaded tires at varying inflation pressures. These data are presented for runways various surface roughness, including grooved and porous friction course runways. Included in the data presentation are bands about each of the curves, which represent variations in: water depths from damp to flooded, runway surface texture within the defined texture levels, tire characteristics, and experimental methods. In defining the standard curves of wet runway braking coefficient versus speed that are prescribed by the equations in § 25.109(c)(1), the effects of the following variables were considered: tire pressure, tire tread depth, runway surface texture, and the depth of the water on the runway.

(A) **Tire Pressure:** Lower tire pressures tend to improve the airplane's stopping capability on a wet runway. The effect of tire pressure is taken into account by providing separate curves (equations) in § 25.109(c)(1) for several tire pressures. As stated in the rule, the tire pressure used to determine the maximum tire-to-ground braking coefficient of friction must be the maximum tire pressure approved for operation. Linear interpolation may be used for tire pressures other than those listed.

(B) **Tire Tread Depth:** The degree to which water can be channeled out from under the tires significantly affects wet runway stopping capability. The standard curves of braking coefficient versus speed prescribed in § 25.109(c)(1) are based on a tire tread depth of 2 mm. This tread depth is consistent with tire removal and retreat practices reported by airplane and tire manufacturers and tire retailers. It is also consistent with FAA guidance provided in AC 121.195(d)-1A, regarding the tread depth for tires used in flight tests to determine operational landing distances on wet runways. Although operation with zero tread depth is not prohibited, it is unlikely that all of the tires on an airplane would be worn to the same extent.

(C) **Runway Surface Texture:** ESDU 71026 groups runways into five categories. These categories are labeled "A" through "E," with "A" being the smoothest and "E" the most heavily textured ungrooved runways. Categories "D" and "E" represent grooved and other open textured surfaces. Category A represents a very smooth texture (an average texture depth of less than 0.004 inches), and is not very prevalent in runways used by transport category airplanes. The majority of ungrooved runways fall into the category C grouping. The curves represented in § 25.109(c)(1) represent a texture midway between categories B and C.

(D) **Depth of Water on the Runway:** Obviously, the greater the water depth, the greater the degradation in braking capability. The curves prescribed in § 25.109(c)(1) represent a well-soaked runway, but with no significant areas of standing water.

(ii) **Anti-Skid System Efficiency.** Section 25.109(c)(2) requires adjusting the maximum tire-to-ground braking coefficient determined in § 25.109(c)(1) to take into account the efficiency of the anti-skid system. The anti-skid system efficiency is defined as the relative capability of the anti-skid system to obtain the maximum friction available between the tire and the runway surface (μ_{max}). It is expressed as either a percentage of μ_{max} or a factor based on that percentage (e.g., 85% or 0.85). Applicants can either use one of the anti-skid efficiency values specified in § 25.109(c)(2), or derive the efficiency from flight tests on a wet runway. Regardless of which method is used, § 25.109(c)(2) requires that an appropriate level of flight testing must be performed to verify that the anti-skid system operates in a manner consistent with the efficiency value used, and that the system has been properly operated on wet runways.

APPENDIX 3

CORRECTION OF AIR MINIMUM CONTROL SPEED TO STANDARD CONDITIONS

The following analysis presents three methods of correcting a flight test derived value of air minimum control speed to standard conditions. These methods are applicable only to rudder deflection limited V_{MCA} for either jet or propeller driven airplanes. The effect of banking into the operating engine is accounted for, and the method will work with either fixed pitch or constant speed propellers, including the effects of windmilling drag. For rudder pedal force limited V_{MCA} , see Appendix 4.

Theoretical Basis

Given the static lateral/directional equations of motion for straight line, unaccelerated flight:

$$\Sigma F_y = 0 \quad C_{Y\beta} \cdot \beta + C_{Y\delta_a} \cdot \delta_a + C_{Y\delta_r} \cdot \delta_r = C_L \cdot \sin \phi \quad (1)$$

$$\Sigma M_x = 0 \quad C_{l\beta} \cdot \beta + C_{l\delta_a} \cdot \delta_a + C_{l\delta_r} \cdot \delta_r = 0 \quad (2)$$

$$\Sigma M_z = 0 \quad C_{n\beta} \cdot \beta + C_{n\delta_a} \cdot \delta_a + C_{n\delta_r} \cdot \delta_r = C_{na} \quad (3)$$

where:

$$C_L = \frac{295 \cdot W}{V_e^2 \cdot S} \quad C_{na} = \frac{295 \cdot F_{ra} \cdot l_e}{V_e^2 \cdot S \cdot b}$$

W = weight - lbs

V_e = equivalent airspeed - kts

S = wing area - ft²

F_{ra} = asymmetric net thrust - lbs

$F_{na} = (F_n + D_w)$ for engine inoperative

$F_{ra} = (F_n + F_r)$ for engine at idle

F_n = net thrust of the operating engine - lbs

F_r = idle engine net thrust - lbs

D_w = windmill drag - lbs

l_e = distance from aircraft center line to engine thrust line - ft

b = wingspan - ft

Constant $C_{L\beta}$ Method

For the case where full rudder deflection is achieved, δ_r is a constant, and the system of equations can be resolved to an identity which shows that C_{na} is a linear function of $C_L \sin \phi$

$$C_{na} = A \cdot C_L \cdot \sin \phi + B \quad (4)$$

(A) Classification of Types of Anti-Skid Systems.

(1) The efficiency values specified in § 25.109(c)(2) are a function of the type of anti-skid system installed on the airplane. Three broad system types are identified in the rule: on/off, quasi-modulating, and fully modulating. These classifications represent evolving levels of technology and differing performance capabilities on dry and wet runways. The classification of anti-skid system types and the assigned efficiency values are based on information contained in Society of Automotive Engineers (SAE) Aerospace Information Report (AIR) 1739, titled "Information on Anti-Skid Systems."

(2) On/off systems are the simplest of the three types of anti-skid systems. For these systems, full-metered brake pressure (as commanded by the pilot) is applied until wheel locking is sensed. Brake pressure is then released to allow the wheel to spin back up. When the system senses that the wheel is accelerating back to synchronous speed (i.e., ground speed), full-metered pressure is again applied. The cycle of full pressure application/complete pressure release is repeated throughout the stop (or until the wheel ceases to skid with pressure applied).

(3) Quasi-modulating systems attempt to continuously regulate brake pressure as a function of wheel speed. Typically, brake pressure is released when the wheel deceleration rate exceeds a preselected value. Brake pressure is re-applied at a lower level after a length of time appropriate to the depth of the skid. Brake pressure is then gradually increased until another incipient skid condition is sensed. In general, the corrective actions taken by these systems to exit the skid condition are based on a pre-programmed sequence rather than the wheel speed time history.

(4) Fully modulating systems are a further refinement of the quasi-modulating systems. The major difference between these two types of anti-skid systems is in the implementation of the skid control logic. During a skid, corrective action is based on the sensed wheel speed signal, rather than a pre-programmed response. Specifically, the amount of pressure reduction or reapplication is based on the rate at which the wheel is going into or recovering from a skid.

(5) In addition to examining the control system for the differences noted above, a time history of the response characteristics of the anti-skid system during a wet runway stop should be used to help identify the type of anti-skid system. Comparing the response characteristics between wet and dry runway stops can also be helpful.

(6) Figure 11-3 shows an example of the response characteristics of a typical on-off system on both dry and wet runways. In general, the on-off system exhibits a cyclic behavior of brake pressure application until a skid is sensed, followed by the complete release of brake pressure to allow the wheel to spin back up. Full-metered pressure (as commanded by the pilot) is then re-applied, starting the cycle over again. The wheel speed trace exhibits deep and frequent skids (the troughs in the wheel speed trace), and the average wheel speed is significantly less than the synchronous speed (which is represented by the flat-topped portions of the wheel speed trace). Note that the skids are deeper and more frequent on a wet runway than on a dry runway. For the particular example shown in Figure 11-3, the brake becomes torque-limited toward the end of the dry runway stop, and is unable to generate enough torque to cause further skidding.

start until after the pilot action that triggers them; that is, they cannot be triggered before the first pilot action and, hence, cannot begin until at least 2 seconds after V_1 .

(6) The sequence for activation of deceleration devices may be selected by the applicant in accordance with § 25.101(f). If, on occasion, the desired sequence is not achieved during testing, the test need not be repeated; however, sufficient tests must be conducted to establish acceptable values of A_{gr} .

(7) Figure 2 shows a pictorial representation of how to apply time delays with up to three deceleration devices. If more than three devices are used to decelerate the airplane, the respective demonstrated time plus a 1-second reaction time delay should be included for each device beyond that represented pictorially in Figure 2 until the airplane is in the full braking configuration.

FIGURE 11-3. ANTI-SKID SYSTEM RESPONSE CHARACTERISTICS
On-Off System

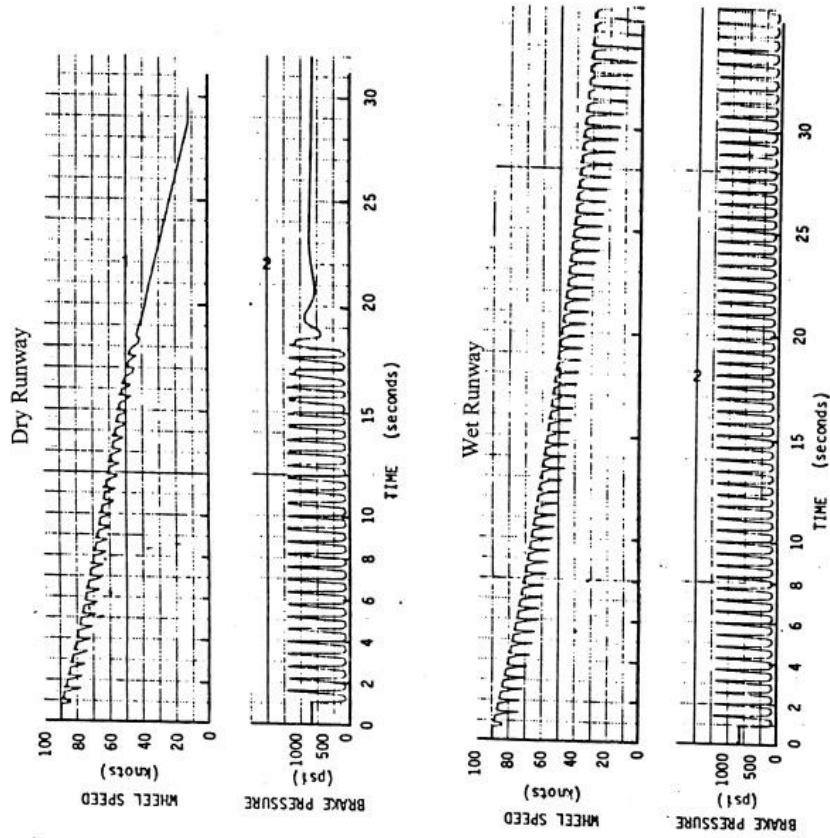

(Z) The effectiveness of quasi-modulating systems can vary significantly depending on the slipperiness of the runway and the design of the particular control system. On dry runways, these systems typically perform very well; however, on wet runways, their performance is highly dependent on the design and tuning of the particular system. An example of the response characteristics of one such system is shown in Figure 11-4. On both dry and wet runways, brake pressure is released to the extent necessary to control skidding. As the wheel returns to the synchronous speed, brake pressure is quickly increased to a pre-determined level and then gradually ramped up to the full-metered brake pressure. On a dry runway, this type of response reduces the depth and frequency of skidding compared to an on-off system. However, on a wet runway, skidding occurs at a pressure below that at which the gradual ramping of brake pressure occurs. As a result, on wet runways the particular system shown in Figure 11-4 operates very similarly to an on-off system.

FIGURE 2. ACCELERATE-STOP TIME DELAYS
(Amendment 25-42 thru Amendment 25-91)

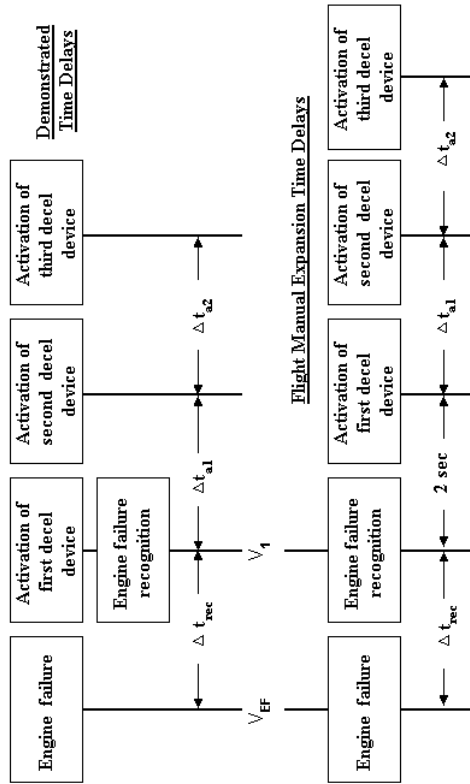

(1) Δt_{rec} - § 25.107 defines the relationship between V_{FF} and V_1 as follows:

" V_{FF} is the calibrated airspeed at which the critical engine is assumed to fail. V_{FF} must be selected by the applicant, but may not be less than V_{MCG} determined under § 25.149(e). V_1 , in terms of calibrated airspeed, is the takeoff decision speed selected by the applicant; however, V_1 may not be less than V_{FF} plus the speed gained with the critical engine inoperative during the time interval between the instant at which the critical engine is failed, and the instant at which the pilot recognizes and reacts to the engine failure, as indicated by the pilot's application of the first retarding means during accelerate-stop tests."

(2) Demonstrated engine failure recognition times less than 1 second should be carefully reviewed to assure the conditions under which they were obtained were representative of that which may reasonably be expected to occur in service. A sufficient number of demonstrations should be conducted using both applicant and FAA test pilots to assure that the time increment is representative and repeatable. The pilot's feet should be on the rudder pedals, not brakes, during demonstration tests.

(3) Δt_{a1} = the demonstrated time interval between activation of the first and second deceleration devices.

(4) Δt_{a2} = the demonstrated time interval between activation of the second and third deceleration devices.

(5) If a command is required for another crewmember to activate a deceleration device, a 1-second delay, in addition to the delays specified in paragraphs (3) and (4) above, should be applied for each action. For automatic deceleration devices which are approved for performance credit for AFM data expansion, established system times determined during certification testing may be used. These established times cannot be assumed to

FIGURE 11-4. ANTI-SKID SYSTEM RESPONSE CHARACTERISTICS
Quasi-Modulating System

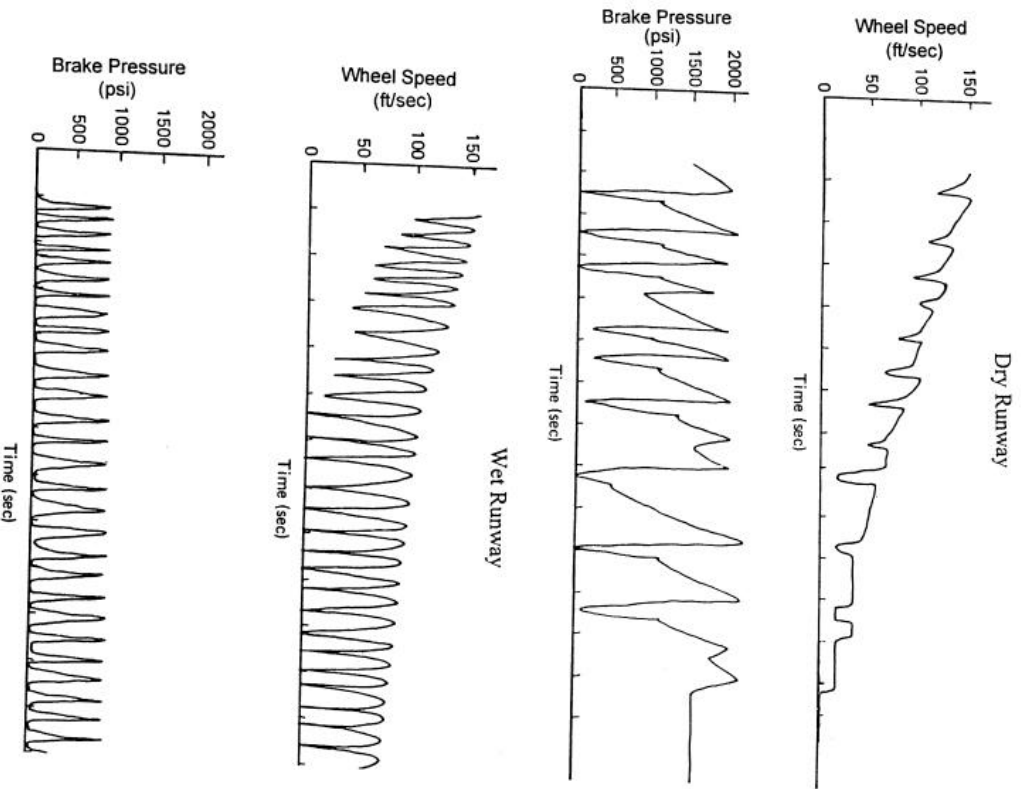

accelerating with the operating engines at takeoff thrust. Figure 2 shows a pictorial representation of the accelerate-stop time delays in accordance with the provisions of part 25, including Amendment 25-42:

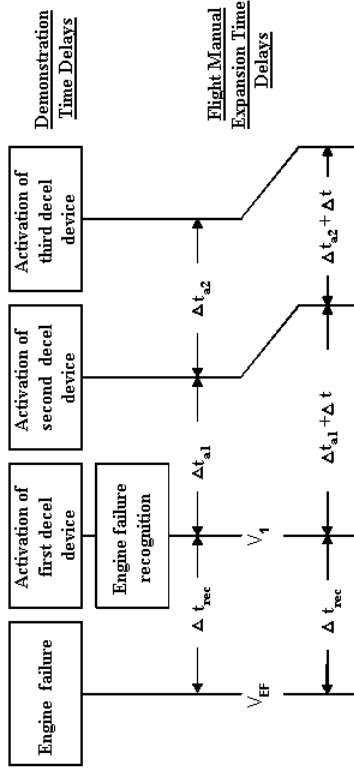

(1) Δt_{rec} = engine failure recognition time. The demonstrated time from engine failure to pilot activation of the first deceleration device, this action indicating recognition of the engine failure. For AFM data expansion purposes, in order to provide a recognition time increment that can be executed consistently in service, it has been found practical to use the demonstrated time or 1 second, whichever is greater. If the airplane incorporates an engine failure warning light, the recognition time includes the time increment necessary for the engine to spool down to the point of warning light activation, plus the time increment from light "on" to pilot action indicating recognition of engine failure.

(2) Δt_{a1} = the demonstrated time interval between activation of the first and second deceleration devices.

(3) Δt_{a2} = the demonstrated time interval between activation of the second and third deceleration devices.

(4) Δt_i = a 1-second reaction time delay to account for in-service variations. If a command is required for another crewmember to actuate a deceleration device, a 2-second delay, in lieu of the 1-second delay, should be applied for each action. For automatic deceleration devices that are approved for performance credit for AFM data expansion, established times determined during certification testing may be used without the application of the additional time delays required by this paragraph.

(5) The sequence for activation of deceleration devices may be selected by the applicant in accordance with § 25.101(f). If, on occasion, the desired sequence is not achieved during testing, the test need not be repeated; however, sufficient tests must be conducted to establish acceptable values of Δt_{a1} .

(6) If additional devices are used to decelerate the airplane, their respective demonstrated times, plus any additional required time delays, should be included until the airplane is in the full braking configuration.

(7) For the purpose of flight manual calculations, the 1-second delay for each action may be added at the end of the total demonstrated time. Regardless of the manner in which the time delays are applied, the flight manual calculations must assume the airplane does not decelerate during the delay time increments.

b. Amendment 25-42 thru Amendment 25-91, Accelerate-Stop Time Delays. Amendment 25-42, effective March 1, 1978, introduced several new requirements affecting accelerate-stop distance determination. One of the most significant changes of Amendment 25-42 was the requirement to determine an all-engines-operating accelerate-stop distance to account for the many rejected takeoffs that were not the result of an engine failure. Amendment 25-42 also introduced into the regulations an engine-failure speed, V_{EF} ; redefined the takeoff decision speed, V_1 ; revised the accelerate-stop distance criteria to correspond to the V_{EF} and V_1 definitions; and added a 2-second time delay between V_1 and the first action to decelerate the airplane during which the airplane continues

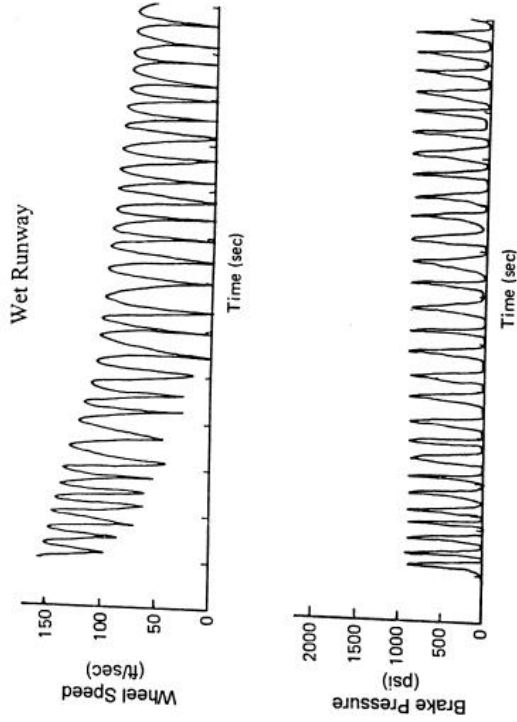

(8) When properly tuned, fully modulating systems are characterized by much smaller variations in brake pressure around a fairly high average value. These systems can respond quickly to developing skids, and are capable of modulating brake pressure to reduce the frequency and depth of skidding. As a result, the average wheel speed remains much closer to the synchronous wheel speed. Figure 11-5 illustrates an example of the response characteristics of a fully modulating system on dry and wet runways.

FIGURE 11-5. ANTI-SKID SYSTEM RESPONSE CHARACTERISTICS
Fully Modulating System

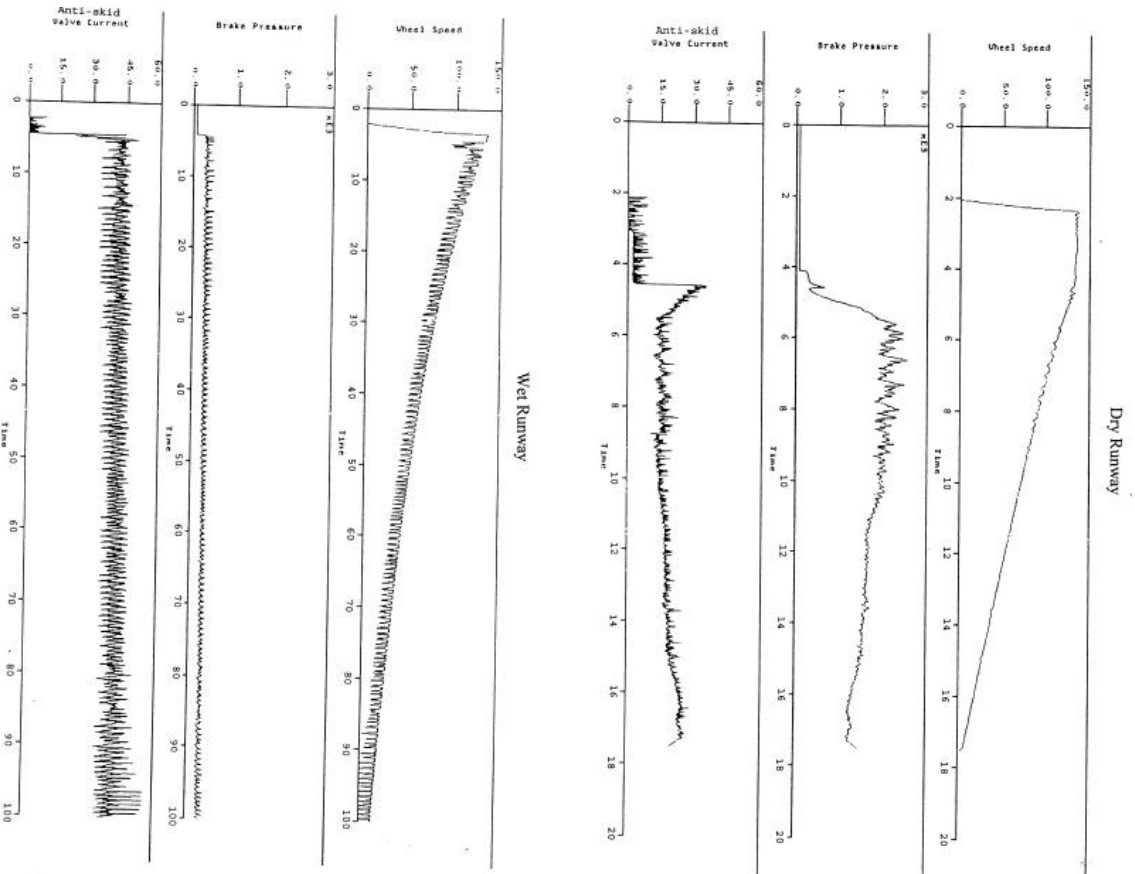

APPENDIX 2

HISTORICAL DEVELOPMENT OF ACCELERATE-STOP TIME DELAYS

1. Explanation.

a. As the rules pertaining to transport category airplane accelerate-stop distances have developed over the years, the interpretation of those rules, with regard to pilot actions, recognition times, and delay times, has also changed. The paragraphs below provide a historical perspective on the application of pilot recognition and delay times, with references to the applicable 14 CFR part 25 amendment number.

b. In accordance with the stipulations of §§ 21.101(a) and (b), the certification basis for a derivative airplane type may be the regulations specified in the type certificate of the basic airplane, depending upon the extent and nature of the changes to the airplane. For those cases where the original certification basis can be retained, the guidance presented in paragraphs 2a and b₂ below, may be used to show compliance with the appropriate regulations. (For more information related to determining a derivative airplane's certification basis, see FAA Order 8110.4A, "Type Certification Process.")

c. Regardless of the certification basis, the effects of brake wear state on energy absorption capability and stopping performance must be addressed. The responsible FAA Aircraft Certification Office (ACO) should be contacted to establish the applicable brake wear criteria for a specific airplane type.

2. Procedures.

a. Pre-Amendment 25-42 Accelerate-Stop Time Delays. Parts 1 and 25 of Title 14 of the CFR, prior to Amendments 1-29 and 25-42, respectively, defined V_1 as the critical engine failure speed. When this definition of V_1 was applied to the accelerate-stop criteria of § 25.109 and the V_1 criteria of § 25.107(a)(2), the implication was that engine failure and engine failure recognition could occur simultaneously. It was recognized that this simultaneous occurrence could not be achieved in actual operations, and that defining V_1 as the engine failure speed resulted in a conflict with § 25.101(b), which requires allowance for time delays in execution of procedures. In order to resolve this conflict, V_1 was applied as the engine failure recognition speed, and appropriate time delays were developed for showing compliance with § 25.101(b). Figure 1 shows a pictorial representation of the accelerate-stop time delays that were considered acceptable for compliance with § 25.101(b) before Amendment 25-42 (effective March 1, 1978). Paragraph (b)(1)(viii) of this appendix provides guidance on reflecting these time delays in the Airplane Flight Manual accelerate-stop distances.

FIGURE 1. ACCELERATE-STOP TIME DELAYS
(Pre-Amendment 25-42)

compliance with subparagraphs (1) through (3) of this paragraph is shown. These distances shall correspond with the elevation of the airport, the runway to be used, the effective runway gradient, and the ambient temperature and wind component existing at the time of takeoff. (See secs. 4T.123(a)(3) and 4T.734(a).)

- (1) The accelerate-stop distance shall not be greater than the length of the runway plus the length of the stopway if present.
- (2) The takeoff distance shall not be greater than the length of the runway plus the length of the clearway if present, except that the length of the clearway shall not be greater than one-half of the length of the runway.
- (3) The takeoff run shall not be greater than the length of the runway.
- (d) No airplane shall be operated outside the operational limits specified in the Airplane Flight Manual. (See secs. 4T.123(a)(4) and 4T.743(a).)

5. The following definitions shall apply:

- (a) *Clearway*: A clearway is an area beyond the runway, not less than 500 feet wide, centrally located about the extended centerline of the runway, and under the control of the airport authorities. The clearway is expressed in terms of a clearway plane, extending from the end of the runway with an upward slope not exceeding 1.25 percent, above which no object nor any portion of the terrain protrudes, except that threshold lights may protrude above the plane if their height above the end of the runway is not greater than 26 inches and if they are located to each side of the runway.

NOTE: For the purpose of establishing takeoff distances and takeoff runs, in accordance with section 4T.117 of this regulation, the clearway plane is considered to be the takeoff surface.

- (b) *Stopway*: A stopway is an area beyond the runway, not less in width than the width of the runway, centrally located about the extended centerline of the runway, and designated by the airport authorities for use in decelerating the airplane during an aborted takeoff. To be considered as such, a stopway must be capable of supporting the airplane during an aborted takeoff without inducing structural damage to the airplane. (See also sec. 4T.115(d) of this regulation.)

(B) Demonstration of Anti-Skid System Operation When Using the Anti-Skid Efficiency Values Specified in § 25.109(c)(2).

(L) If the applicant elects to use one of the anti-skid efficiency values specified in § 25.109(c)(2), a limited amount of flight testing must still be conducted to verify that the anti-skid system operates in a manner consistent with the type of anti-skid system declared by the applicant. This testing should also demonstrate that the anti-skid system has been properly tuned for operation on wet runways.

(2) A minimum of one complete stop, or equivalent segmented stops, should be conducted on a smooth (i.e., not grooved or porous friction course) wet runway at an appropriate speed and energy to cover the critical operating mode of the anti-skid system. Since the objective of the test is to observe the operation (i.e., cycling) of the anti-skid system, this test will normally be conducted at an energy well below the maximum brake energy condition.

(3) The section of the runway used for braking should be well soaked (i.e., not just damp), but not flooded. The runway test section should be wet enough to result in a number of cycles of anti-skid activity, but should not cause hydroplaning.

(4) Before taxi and with cold tires, the tire pressure should be set to the highest value appropriate to the takeoff weight for which approval is being sought.

(5) The tires and brakes should not be new, but need not be in the fully worn condition. They should be in a condition considered representative of typical in-service operations.

(6) Sufficient data should be obtained to determine whether the system operates in a manner consistent with the type of anti-skid system declared by the applicant, provide evidence that full brake pressure is being applied upstream of the anti-skid valve during the flight test demonstration, determine whether the anti-skid valve is performing as intended, and show that the anti-skid system has been properly tuned for a wet runway. Typically, the following parameters should be plotted versus time:

- (i) The speed of a representative number of wheels.
- (ii) The hydraulic pressure at each brake (i.e., the hydraulic pressure downstream of the anti-skid valve or the electrical input to each anti-skid valve).
- (iii) The hydraulic pressure at each brake metering valve (i.e., upstream of the anti-skid valve).

(L) A qualitative assessment of anti-skid system response and airplane controllability should be made by the test pilot(s). In particular, pilot observations should confirm that:

- (i) Anti-skid releases are neither excessively deep nor prolonged;
- (ii) The landing gear is free of unusual dynamics; and
- (iii) The airplane tracks essentially straight, even though runway seams, water puddles, and wetter patches may not be uniformly distributed in location or extent.

(C) Determination of a Specific Wet Runway Anti-Skid System Efficiency.

(L) If the applicant elects to derive the anti-skid system efficiency from flight test demonstrations, sufficient flight testing, with adequate instrumentation, must be conducted to ensure confidence in the value obtained. An anti-skid efficiency of 92 percent (i.e., a factor of 0.92) is considered to be the maximum efficiency on a wet runway normally achievable with fully modulating digital anti-skid systems.

- conducted on a wet runway at appropriate speeds and energies to cover the critical operating modes of the anti-skid system. Alternatively, if the operation and efficiency of the anti-skid system on a wet runway can be predicted by laboratory simulation data and validated by flight test demonstrations, a lesser number of stops may be acceptable. In this case, as many complete stops, or equivalent segmented stops, as necessary to present six independent anti-skid efficiency calculations should be conducted on a wet runway at appropriate speeds and energies to cover the critical operating modes of the anti-skid system. An independent anti-skid efficiency calculation can be presented for each stop for each independently controlled wheel, or set of wheels.
- (3) Since the objective of the test is to determine the efficiency of the anti-skid system, these tests will normally be conducted at energies well below the maximum brake energy condition. A sufficient range of speeds should be covered to investigate any variation of the anti-skid efficiency with speed.
- (4) The testing should be conducted on a smooth (i.e., not grooved or porous friction course) runway. If the applicant chooses to determine accelerate-stop distances for grooved and porous friction course (PFC) surfaces under § 25.109(d)(2), testing should also be conducted on a grooved or porous friction course runway to determine the anti-skid efficiency value applicable to those surfaces. Other means for determining the anti-skid efficiency value for grooved and PFC surfaces may also be acceptable, such as using the efficiency value previously determined for smooth runways, if that value is shown to also be representative of or conservative for grooved and PFC runways.
- (5) The section of the runway used for braking should be well soaked (i.e., not just damp), but not flooded. The runway test section should be wet enough to result in a number of cycles of anti-skid activity, but should not cause hydroplaning.
- (6) Before taxi and with cold tires, the tire pressure should be set to the highest value appropriate to the takeoff weight for which approval is being sought.
- (7) The tires and brakes should not be new, but need not be in the fully worn condition. They should be in a condition considered representative of typical in-service operations.
- (8) A qualitative assessment of anti-skid system response and airplane controllability should be made by the test pilot(s). In particular, pilot observations should confirm that:
- (i) The landing gear is free of unusual dynamics; and
 - (ii) The airplane tracks essentially straight, even through runway seams, water puddles, and wetter patches may not be uniformly distributed in location or extent.
- (9) Two acceptable methods, referred to as the torque method and the wheel slip method, for determining the wet runway anti-skid efficiency value from wet runway stopping tests are described below. Other methods may also be acceptable if they can be shown to give equivalent results. The test instrumentation and data collection should be consistent with the method used.
- (i) **Torque Method:**
- (a) Under the torque method, the anti-skid system efficiency is determined by comparing the energy absorbed by the brake during an actual wet runway stop to the energy that is determined by integrating, over the stopping distance, a curve defined by connecting the peaks of the instantaneous brake force curve (see Figure 11-6). The energy absorbed by the brake during the actual wet runway stop is determined by integrating the curve of instantaneous brake force over the stopping distance.

FIGURE 11-6. INSTANTANEOUS BRAKE FORCE AND PEAK BRAKE FORCE

- (2) The net flight path shall have a positive slope at 1,500 feet above the airport where the landing is assumed to be made after failure of two engines.
- (3) Fuel jettisoning shall be permitted if the Administrator finds that the operator has an adequate training program, proper instructions are given to the flight crew, and all other precautions are taken to ensure a safe procedure.
- (4) The airplane's weight at the point where the two engines are assumed to fail shall be considered to be not less than that which would include sufficient fuel to proceed to the airport and to arrive there at an altitude of at least 1,500 feet directly over the landing area and thereafter to fly for 15 minutes at cruise power and/or thrust.
- (5) The consumption of fuel and oil after the engines are assumed to fail shall be that which is accounted for in the net flight path data shown in the Airplane Flight Manual.

40T.84 Landing limitations.

- (a) *Airport of destination.* No airplane shall be taken off at a weight in excess of that which, in accordance with the landing distances shown in the Airplane Flight Manual for the elevation of the airport of intended destination and for the wind conditions anticipated there at the time of landing, would permit the airplane to be brought to rest at the airport of intended destination within 60 percent of the effective length of the runway from a point 50 feet directly above the intersection of the obstruction clearance plane and the runway. The weight of the airplane shall be assumed to be reduced by the weight of the fuel and oil expected to be consumed in flight to the airport of intended destination. Compliance shall be shown with the conditions of subparagraphs (1) and (2) of this paragraph. (See secs. 4T.123(b) and 4T.743(b).)
- (1) It shall be assumed that the airplane is landed on the most favorable runway and direction in still air.
- (2) It shall be assumed that the airplane is landed on the most suitable runway considering the probable wind velocity and direction and taking due account of the ground handling characteristics of the airplane and of other conditions (i.e., landing aids, terrain, etc.). If full compliance with the provisions of this subparagraph is not shown, the airplane may be taken off if an alternate airport is designated which permits compliance with paragraph (b) of this section.
- (b) *Alternate airport.* No airport shall be designated as an alternate airport in a dispatch release unless the airplane at the weight anticipated at the time of arrival at such airport can comply with the provisions of paragraph (a) of this section, provided that the airplane can be brought to rest within 70 percent of the effective length of the runway.
4. In lieu of section 43.11 of Part 43 of the Civil Air Regulations the following shall be applicable.

43T.11 Transport category airplane weight limitations. The performance data in the Airplane Flight Manual shall be applied in determining compliance with the following provisions:

- (a) No airplane shall be taken off at a weight which exceeds the takeoff weight specified in the Airplane Flight Manual for the elevation of the airport and for the ambient temperature existing at the time of the takeoff. (See secs. 4T.123(a)(1) and 4T.743(a).)
- (b) No airplane shall be taken off at a weight such that, allowing for normal consumption of fuel and oil in flight to the airport of destination and to the alternate airports, the weight on arrival will exceed the landing weight specified in the Airplane Flight Manual for the elevation of each of the airports involved and for the ambient temperatures anticipated at the time of landing. (See secs. 4T.123(a)(2) and 4T.743(a).)
- (c) No airplane shall be taken off at a weight which exceeds the weight at which, in accordance with the minimum distances for takeoff scheduled in the Airplane Flight Manual,

order to avoid obstacles by at least the distances prescribed, it shall be assumed that the airplane is not banked before reaching a height of 50 feet as shown by the net takeoff flight path data in the Airplane Flight Manual, and that a maximum bank thereafter does not exceed 15 degrees. The net takeoff flight path considered shall be for the elevation of the airport, the effective runway gradient, and for the ambient temperature and wind component existing at the time of takeoff. (See secs. 4T.123(b) and 4T.743(b).)

40T.83 En route limitations. All airplanes shall be operated in compliance with paragraph (a) of this section. In addition, no airplane shall be flown along an intended route if any place along the route is more than 90 minutes away from an airport at which a landing can be made in accordance with section 40T.84(b), assuming all engines to be operating at cruising power, unless compliance is shown with paragraph (b) of this section.

(a) *One engine inoperative.* No airplane shall be taken off at a weight in excess of that which, according to the one-engine-inoperative en route net flight path data shown in the Airplane Flight Manual, will permit compliance with either subparagraphs (1) or (2) of this paragraph at all points along the route. The net flight path shall have a positive slope at 1,500 feet above the airport where the landing is assumed to be made after the engine fails. The net flight path used shall be for the ambient temperatures anticipated along the route. (See secs. 4T.123(b) and 4T.743(b).)

(1) The slope of the net flight path shall be positive at an altitude of at least 1,000 feet above all terrain and obstructions along the route within 5 statute miles (4.34 nautical miles) on either side of the intended track.

(2) The net flight path shall be such as to permit the airplane to continue flight from the cruising altitude to an airport where a landing can be made in accordance with the provisions of section 40T.84(b), the net flight path clearing vertically by at least 2,000 feet all terrain and obstructions along the route within 5 statute miles (4.34 nautical miles) on either side of the intended track. The provisions of subdivisions (i) through (vi) of this subparagraph shall apply.

- (i) The engine shall be assumed to fail at the most critical point along the route.
- (ii) The airplane shall be assumed to pass over the critical obstruction following engine failure at a point no closer to the critical obstruction than the nearest approved radio navigational fix, except that the Administrator may authorize a procedure established on a different basis where adequate operational safeguards are found to exist.
- (iii) An approved method shall be used to account for winds which would otherwise adversely affect the flight path.
- (iv) Fuel jettisoning shall be permitted if the Administrator finds that the operator has an adequate training program, proper instructions are given to the flight crew, and all other precautions are taken to ensure a safe procedure.
- (v) The alternate airport shall be specified in the dispatch release and shall meet the prescribed weather minima.
- (vi) The consumption of fuel and oil after the engine is assumed to fail shall be that which is accounted for in the net flight path data shown in the Airplane Flight Manual.
- (b) *Two engines inoperative.* No airplane shall be taken off at a weight in excess of that which, according to the two-engine-inoperative en route net flight path data shown in the Airplane Flight Manual, will permit the airplane to continue flight from the point where two engines are assumed to fail simultaneously to an airport where a landing can be made in accordance with the provisions of section 40T.84(b), the net flight path clearing vertically by at least 2,000 feet all terrain and obstructions along the route within 5 statute miles (4.34 nautical miles) on either side of the intended track. The net flight path considered shall be for the ambient temperatures anticipated along the route. The provisions of subparagraphs (1) through (5) of this paragraph shall apply. (See secs. 4T.123(b) and 4T.734(b).)
- (1) The two engines shall be assumed to fail at the most critical point along the route.

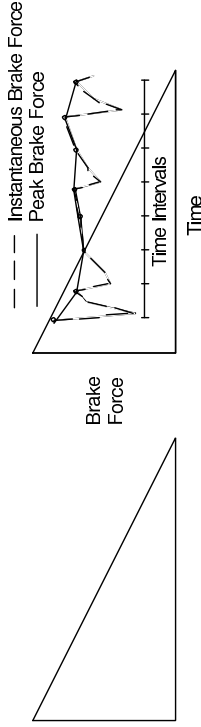

11c(4)(ii)(C), instantaneous brake force can be calculated from the following relationship:

$$F_b = \frac{(T_b + \alpha I)}{R_{\text{tire}}}$$

where: F_b = brake force
 T_b = brake torque
 α = wheel acceleration
 I = wheel and tire moment of inertia
 and R_{tire} = tire radius.

(c) For brake installations where measuring brake torque directly is impractical, torque may be determined from other parameters (e.g., brake pressure) if a suitable correlation is available. Wheel acceleration is obtained from the first derivative of wheel speed. Instrumentation recording rates and data analysis techniques for wheel speed and torque data should be well matched to the anti-skid response characteristics to avoid introducing noise and other artifacts of the instrumentation system into the data.

(d) Since the derivative of wheel speed is used in calculating brake force, smoothing of the wheel speed data is usually necessary to give good results. The smoothing algorithm should be carefully designed as it can affect the resulting efficiency calculation. Filtering or smoothing of the brake torque or brake force data should not normally be done. If conditioning is applied, it should be done in a conservative manner (i.e., result in a lower efficiency value) and should not misrepresent actual airplane/system dynamics.

(e) Both the instantaneous brake force and the peak brake force should be integrated over the stopping distance. The anti-skid efficiency value for determining the wet runway accelerate-stop distance is the ratio of the instantaneous brake force integral to the peak brake force integral:

$$\text{anti-skid efficiency} = \frac{\int \text{instantaneous brake force} \cdot ds}{\int \text{peak brake force} \cdot ds}$$

where s = stopping distance

(f) The stopping distance is defined as the distance traveled during the specific wet runway stopping demonstration, beginning when the full braking configuration is obtained and ending at the lowest speed at which anti-skid cycling occurs (i.e., the brakes are not torque-limited), except that this speed need not be less than 10 knots. Any variation in the anti-skid efficiency with speed should also be investigated, which can be accomplished by determining the efficiency over segments of the total stopping distance. If significant variations are noted, this variation should be reflected in the braking force used to determine the accelerate-stop distances (either by using a variable efficiency or by using a conservative single value).

(j) Wheel Slip Method:

(a) At brake application, the tire begins to slip with respect to the runway surface (i.e., the wheel speed slows down with respect to the airplane's ground speed). As the amount of tire slip increases, the brake force also increases until an optimal slip is reached. If the amount of slip continues to increase past the optimal slip, the braking force will decrease.

(b) Using the wheel slip method, the anti-skid efficiency is determined by comparing the actual wheel slip measured during a wet runway stop to the optimal slip. Since the wheel slip varies significantly during the stop, sufficient wheel and ground speed data must be obtained to determine the variation of both the actual wheel slip and the optimal wheel slip over the length of the stop. A sampling rate of at least 16 samples per second for both wheel speed and ground speed has been found to yield acceptable fidelity.

(c) For each wheel and ground speed data point, the instantaneous anti-skid efficiency value should be determined from the relationship shown in Figure 11-7.

FIGURE 11-7. ANTI-SKID EFFICIENCY - WHEEL SLIP RELATIONSHIP

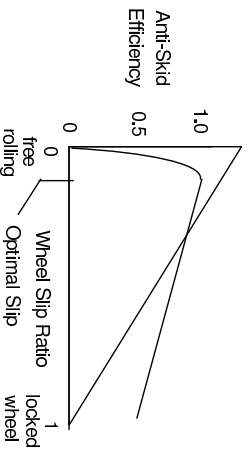

for $WSR < OPS$ Efficiency = $1.5 \left(\frac{WSR}{OPS} \right) - 0.5 \left(\frac{WSR}{OPS} \right)^3$

WSR = OPS Efficiency = 1.0

WSR > OPS Efficiency = $0.5 \left(1 + \frac{(1 - WSR)}{(1 - OPS)} \right)$

where WSR = the wheel slip ratio = $1 - \left(\frac{\text{Wheel speed}}{\text{Ground speed}} \right)$

and OPS is the optimal slip ratio

(d) To determine the overall anti-skid efficiency value for use in calculating the wet runway accelerate-stop distance, the instantaneous anti-skid efficiencies should be integrated with respect to distance and divided by the total stopping distance:

$$\text{anti - skid efficiency} = \frac{\int \text{instantane ops efficiency} \cdot ds}{s}$$

(d) *Miscellaneous.* An explanation shall be given of significant or unusual flight or ground handling characteristics of the airplane.

3. In lieu of sections 40.70 through 40.78, 41.27 through 41.36(d), and 42.70 through 42.83, of Parts 40, 41, and 42, respectively, of the Civil Air Regulations, the following shall be applicable:

OPERATING RULES

40T.80 *Transport category airplane operating limitations.*

(a) In operating any passenger-carrying transport category airplane certificated in accordance with the performance requirements of this regulation, the provisions of sections 40T.80 through 40T.84 shall be complied with, unless deviations therefrom are specifically authorized by the Administrator on the ground that the special circumstances of a particular case make a literal observance of the requirements unnecessary for safety.

(b) The performance data in the Airplane Flight Manual shall be applied in determining compliance with the provisions of sections 40T.81 through 40.84. Where conditions differ from those for which specific tests were made, compliance shall be determined by approved interpolation or computation of the effects of changes in the specific variables if such interpolations or computations give results substantially equaling in accuracy the results of a direct test.

40T.81 *Airplane's certificate limitations.*

(a) No airplane shall be taken off at a weight which exceeds the takeoff weight specified in the Airplane Flight Manual for the elevation of the airport and for the ambient temperature existing at the time of the takeoff. (See secs. 4T.123(a)(1) and 4T.743(a).)

(b) No airplane shall be taken off at a weight such that, allowing for normal consumption of fuel and oil in flight to the airport of destination and to the alternate airports, the weight on arrival will exceed the landing weight specified in the Airplane Flight Manual for the elevation of each of the airports involved and for the ambient temperatures anticipated at the time of landing. (See secs. 4T.123(a)(2) and 4T.743(a).)

(c) No airplane shall be taken off at a weight which exceeds the weight at which, in accordance with the minimum distances for takeoff scheduled in the Airplane Flight Manual, compliance with subparagraphs (1) through (3) of this paragraph is shown. These distances shall correspond with the elevation of the airport, the runway to be used, the effective runway gradient, and the ambient temperature and wind component existing at the time of takeoff. (See secs. 4T.123(a)(3) and 4T.743(a).)

(1) The accelerate-stop distance shall not be greater than the length of the runway plus the length of the stopway, if present.

(2) The takeoff distance shall not be greater than the length of the runway plus the length of the clearway, if present, except that the length of the clearway shall not be greater than one-half of the length of the runway.

(3) The takeoff run shall not be greater than the length of the runway.

(d) No airplane shall be operated outside the operational limits specified in the Airplane Flight Manual (See secs. 4T.123(a)(4) and 4T.743(a).)

40T.82 *Takeoff obstacle clearance limitations.* No airplane shall be taken off at a weight in excess of that shown in the Airplane Flight Manual to correspond with a net takeoff flight path which clears all obstacles either by at least a height of 35 feet vertically or by at least 200 feet horizontally within the airport boundaries and by at least 300 feet horizontally after passing beyond the boundaries. In determining the allowable deviation of the net takeoff flight path in

where s = stopping distance

(a) *Limitations.* The performance limitations on the operation of the airplane shall be established in accordance with subparagraph (1) through (4) of this paragraph. (See also sec. 4T.743.)

(1) *Takeoff weights.* The maximum takeoff weights shall be established at which compliance is shown with the generally applicable provisions of this regulation and with the takeoff climb provisions prescribed in section 4T.120 (a), (b), and (c) for altitudes and ambient temperatures, within the operational limits of the airplane (see subparagraph (4) of this paragraph).

(2) *Landing weights.* The maximum landing weights shall be established at which compliance is shown with the generally applicable provisions of this regulation and with the landing and takeoff climb provisions prescribed in sections 4T.119 and 4T.120 for altitudes and ambient temperatures, within the operational limits of the airplane (see subparagraph (4) of this paragraph).

(3) *Accelerate-stop distance, takeoff distance, and takeoff run.* The minimum distances required for takeoff shall be established at which compliance is shown with the generally applicable provisions of this regulation and with sections 4T.115 and 4T.117(a) and with 4T.117(b) if the takeoff distance is intended to include a clearance, for weights, altitudes, temperatures, wind components, and runway gradients, within the operational limits of the airplane (see subparagraph (4) of this paragraph).

(4) *Operational limits.* The operational limits of the airplane shall be established by the applicant for all variable factors required in showing compliance with this regulation (weight, altitude, temperature, etc.). (See secs. 4T.113 (a)(1) and (b), 4T.115(d), 4T.118, 4T.121, and 4T.122.)

(b) *Information.* The performance information on the operation of the airplane shall be scheduled in compliance with the generally applicable provisions of this regulation and with sections 4T.117a(b), 4T.121, and 4T.122 for weights, altitudes, temperatures, wind components and runway gradients, as these may be applicable, within the operational limits of the airplane (see subparagraph (a) (4) of this section). In addition, the performance information specified in subparagraphs (1) through (3) of this paragraph shall be determined by extrapolation and scheduled for the ranges of weights between the maximum landing and maximum takeoff weights established in accordance with subparagraphs (a)(1) and (a) (2) of this section. (See also sec. 4T.743.)

(1) Climb in the landing configuration (see sec. 4T.119);

(2) Climb in the approach configuration (see sec. 4T.120(d));

(3) Landing distance (see sec. 4T.122).

AIRPLANE FLIGHT MANUAL

4T.743 *Performance limitations, information, and other data.*

(a) *Limitations.* The airplane's performance limitations shall be given in accordance with section 4T.123(a).

(b) *Information.* The performance information prescribed in section 4T.123(b) for the application of the operating rules of this regulation shall be given together with descriptions of the conditions, air speeds, etc., under which the data were determined.

(c) *Procedures.* Procedures established in accordance with section 4T.111(c) shall be given to the extent such procedures are related to the limitations and information set forth in accordance with paragraphs (a) and (b) of this section. Such procedures, in the form of guidance material, shall be included with the relevant limitations or information, as applicable.

(c) The stopping distance is defined as the distance traveled during the specific wet runway stopping demonstration, beginning when the full braking configuration is obtained and ending at the lowest speed at which anti-skid cycling occurs (i.e., the brakes are not torque-limited), except that this speed need not be less than 10 knots. Any variation in the anti-skid efficiency with speed should also be investigated, which can be accomplished by determining the efficiency over segments of the total stopping distance. If significant variations are noted, this variation should be reflected in the braking force used to determine the accelerate-stop distances (either by using a variable efficiency or by using a conservative single value).

(f) The applicant should provide substantiation of the optimal wheel slip value(s) used to determine the anti-skid efficiency value. An acceptable method for determining the optimal slip value(s) is to compare time history plots of the brake force and wheel slip data obtained during the wet runway stopping tests. For brake installations where measuring brake force directly is impractical, brake force may be determined from other parameters (e.g., brake pressure) if a suitable correlation is available. For those skids where wheel slip continues to increase after a reduction in the brake force, the optimal slip is the slip value corresponding to the brake force peak. See Figure 11-8 for an example and note how both the actual wheel slip and the optimal wheel slip can vary during the stop.

FIGURE 11-8. SUBSTANTIATION OF THE OPTIMAL SLIP VALUE

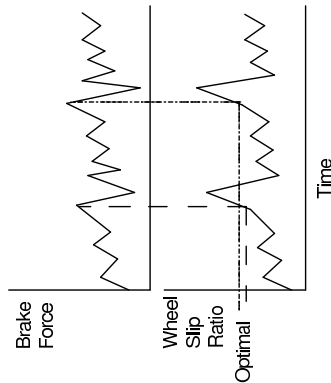

(D) For dispatch with an inoperative anti-skid system (if approved), the wet runway accelerate-stop distances should be based on an efficiency no higher than that allowed by § 25.109(c)(2) for an on-off type of anti-skid system. The safety of this type of operation should be demonstrated by flight tests conducted in accordance with paragraph 11c(4)(ii)(B).

(iii) *Distribution of the Normal Load Between Braked and Unbraked Wheels.* In addition to taking into account the efficiency of the anti-skid system, § 25.109(b)(2)(ii) also requires adjusting the braking force for the effect of the distribution of the normal load between braked and unbraked wheels at the most adverse center-of-gravity position approved for takeoff. The stopping force due to braking is equal to the braking coefficient multiplied by the normal load (i.e., weight) on each braked wheel. The portion of the airplane's weight being supported by the unbraked wheels (e.g., unbraked nose wheels) does not contribute to the stopping force generated by the brakes. This effect must be taken into account for the most adverse center-of-gravity position approved for takeoff, considering any redistribution in loads that occur due to the dynamics of the stop. The most adverse center-of-gravity position is the position that results in the least load on the braked wheels.

(iv) *Grooved and Porous Friction Course (PFC) Runways.* Properly designed, constructed, and maintained grooved and PFC runways can offer significant improvements in wet runway braking capability. A

conservative level of performance credit is provided by § 25.109(d) to reflect this performance improvement and to provide an incentive for installing and maintaining such surfaces.

(A) In accordance with §§ 25.105(c) and 25.109(d), applicants may optionally determine the accelerate-stop distance applicable to wet grooved and PFC runways. These data would be included in the AFM in addition to the smooth runway accelerate-stop distance data. The braking coefficient for determining the accelerate-stop distance on grooved and PFC runways is defined in § 25.109(d) as either 70 percent of the braking coefficient used to determine the dry runway accelerate-stop distances, or a curve based on ESDU 71026 data and derived in a manner consistent with that used for smooth runways. In either case, the brake torque limitations determined on a dry runway may not be exceeded.

(B) Using a simple factor applied to the dry runway braking coefficient is acceptable for grooved and PFC runways because the braking coefficient's variation with speed is much lower on these types of runways. On smooth wet runways, the braking coefficient varies significantly with speed, which makes it inappropriate to apply a simple factor to the dry runway braking coefficient.

(C) For applicants who choose to determine the grooved/PFC wet runway accelerate-stop distances in a manner consistent with that used for smooth runways, § 25.109(d)(2) provides the maximum tire-to-ground braking coefficient applicable to grooved and PFC runways. This maximum tire-to-ground braking coefficient must be adjusted for the anti-skid system efficiency, either by using the value specified in § 25.109(c)(2) appropriate to the type of anti-skid system installed, or by using a specific efficiency established by the applicant. As anti-skid system performance depends on the characteristics of the runway surface, a system that has been tuned for optimum performance on a smooth surface may not achieve the same level of efficiency on a grooved or porous friction course runway, and vice versa. Consequently, if the applicant elects to establish a specific efficiency for use with grooved or PFC surfaces, anti-skid efficiency testing should be conducted on a wet runway with such a surface, in addition to testing on a smooth runway. Means other than flight testing may be acceptable, such as using the efficiency previously determined for smooth wet runways, if that efficiency is shown to be representative of, or conservative for, grooved and PFC runways. The resulting braking force for grooved/PFC wet runways must be adjusted for the effect of the distribution of the normal load between braked and unbraked wheels. This adjustment will be similar to that used for determining the braking force for smooth wet runways, except that the braking dynamics should be appropriate to the braking force achieved on grooved and PFC wet runways. Due to the increased braking force on grooved and PFC wet runways, an increased download on the nose wheel and corresponding reduction in the download on the main gear is expected.

(D) In accordance with §§ 25.1533(a)(3) and 25.1583(h), grooved and PFC wet runway accelerate-stop distances may be established as operating limitations and be presented in the AFM, but approval to use these distances is limited to runways that have been designed, constructed, and maintained in a manner acceptable to the FAA Administrator. Airplane operators who wish to use the grooved or PFC runway accelerate-stop distances must determine that the design, construction, and maintenance aspects are acceptable for each runway for which such credit is sought. Advisory Circular 150/5320-12C, "Measurement, Construction, and Maintenance of Skid-Resistant Airport Pavement Surfaces," provides guidance relative to acceptable design, construction, and maintenance practices for grooved and PFC runway surfaces.

(V) **Reverse-thrust performance credit.** In accordance with § 25.109(f), reverse thrust may not be used to determine the accelerate-stop distances for a dry runway. For wet runway accelerate-stop distances, however, § 25.109(f) allows credit for the stopping force provided by reverse thrust, if the requirements of § 25.109(e) are met. In addition, the procedures associated with the use of reverse thrust, which § 25.101(f) requires the applicant to provide, must meet the requirements of § 25.101(h). The following criteria provide acceptable means of demonstrating compliance with these requirements:

(A) Procedures for using reverse thrust during a rejected takeoff must be developed and demonstrated. These procedures should include all of the pilot actions necessary to obtain the recommended level of reverse thrust, maintain directional control and safe engine operating characteristics, and return the reverser(s), as applicable, to either the idle or the stowed position. These procedures need not be the same as those recommended for use during a landing stop, but must not result in additional hazards (e.g., cause a flameout or any adverse engine operating characteristics), nor may they significantly increase flightcrew workload or training needs.

shall be acceptable to include in these data the variation of the airplane's weight along the flight path to take into account the progressive consumption of fuel and oil by the operating engines.

(c) *Conditions.* In determining the flight paths prescribed in paragraphs (a) and (b) of this section, the conditions of subparagraphs (1) through (4) of this paragraph shall apply.

(1) The airplane's center of gravity shall be in the most unfavorable position.

(2) The critical engine(s) shall be inoperative, the remaining engine(s) operating at the available maximum continuous power and/or thrust.

(3) Means for controlling the engine cooling air supply shall be in the position which provides adequate cooling in the hot-day condition.

(4) The speed shall be selected by the applicant.

4T.122 *Landing distance.* The landing distance shall be the horizontal distance required to land and to come to a complete stop (to a speed of approximately 3 knots in the case of seaplanes or float planes) from a point at a height of 50 feet above the landing surface. Landing distances shall be determined for standard temperatures at all weights, altitudes, and winds, within the operational limits established by the applicant for the airplane. The conditions of paragraphs (a) through (g) of this section shall apply.

(a) The airplane shall be in the landing configuration. During the landing, changes in the airplane's configuration, in power and/or thrust, and in speed shall be in accordance with procedures established by the applicant for the operation of the airplane in service. The procedures shall comply with the provisions of section 4T.111(c).

(b) The landing shall be preceded by a steady gliding approach down to the 50-foot height with a calibrated air speed of not less than 1.3 V_s.

(c) The landing distance shall be based on a smooth, dry, hard-surfaced runway, and shall be determined in such a manner that reproduction does not require exceptional skill or alertness on the part of the pilot. In the case of seaplanes or floatplanes, the landing surface shall be smooth water, while for skiplanes it shall be smooth, dry snow. During landing, the airplane shall not exhibit excessive vertical acceleration, a tendency to bounce, nose over, ground loop, porpoise, or water loop.

(d) The landing distance data shall include operational correction factors for not more than 50 percent of nominal wind components along the landing path opposite to the direction of landing and not less than 150 percent of nominal wind components along the landing path in the direction of landing.

(e) During landing, the operating pressures on the wheel braking system shall not be in excess of those approved by the manufacturer of the brakes, and the wheel brakes shall not be used in such a manner as to produce excessive wear of brakes and tires.

(f) In addition to, or in lieu of, wheel brakes, the use of other braking means shall be acceptable in determining the landing distance, provided such braking means shall have been proven to be safe and reliable, that the manner of their employment is such that consistent results can be expected in service, and that exceptional skill is not required to control the airplane.

(g) If the characteristics of a device (e.g., the propellers) dependent upon the operation of any of the engines noticeably increase the landing distance when the landing is made with the engine inoperative, the landing distance shall be determined with the critical engine inoperative unless the Administrator finds that the use of compensating means will result in a landing distance not greater than that attained with all engines operating.

4T.123 *Limitations and information.*

the airplane's landing gear is initiated, unless subsequently a more critical power operating condition exists along the flight path prior to the point where the landing gear is fully retracted;

(2) The weight equal to the airplane's weight existing in accordance with section 4T.116 at the time retraction of the airplane's landing gear is initiated;

(3) The speed equal to the speed V_{LOF} .

(b) *Takeoff: landing gear retracted.* In the takeoff configuration existing at the point of the flight path where the airplane's landing gear is fully retracted, in accordance with section 4T.116 but without ground effect, the steady gradient of climb shall not be less than 2.4 percent for two-engine airplanes and not less than 3.0 percent for four-engine airplanes, with:

(1) The critical engine inoperative, the remaining engine(s) operating at the available takeoff power and/or thrust existing in accordance with section 4T.116 at the time the landing gear is fully retracted, unless subsequently a more critical power operating condition exists along the flight path prior to the point where a height of 400 feet above the takeoff surface is reached;

(2) The weight equal to the airplane's weight existing in accordance with section 4T.116 at the time the airplane's landing gear is fully retracted;

(3) The speed equal to the speed V_2 .

(c) *Final takeoff.* In the en route configuration, the steady gradient of climb shall not be less than 1.2 percent for two-engine airplanes and not less than 1.7 percent for four-engine airplanes, at the end of the takeoff path as determined by section 4T.116, with:

(1) The critical engine inoperative, the remaining engine(s) operating at the available maximum continuous power and/or thrust;

(2) The weight equal to the airplane's weight existing in accordance with section 4T.116 at the end of the takeoff path.

(3) The speed equal to not less than $1.25 V_S$.

(d) *Approach.* In the approach configuration corresponding with the normal all-engines-operating procedure such that V_S related to this configuration does not exceed 110 percent of the V_S corresponding with the related landing configuration, the steady gradient of climb shall not be less than 2.1 percent for two-engine airplanes and not less than 2.7 percent for four-engine airplanes with:

(1) The critical engine inoperative, the remaining engine(s) operating at the available takeoff power and/or thrust;

(2) The weight equal to the maximum landing weight;

(3) A climb speed established by the applicant in connection with normal landing procedures, except that it shall not exceed $1.5 V_S$, (see sec. 4T.111(c)).

4T.121 *En route flight paths.* With the airplane in the en route configuration, the flight paths prescribed in paragraphs (a) and (b) of this section shall be determined at all weights, altitudes, and ambient temperatures, within the operational limits established by the applicant for the airplane.

(a) *One engine inoperative.* The one-engine-inoperative net flight path data shall be determined in such a manner that they represent the airplane's actual climb performance diminished by a gradient of climb equal to 1.1 percent for two-engine airplanes and 1.6 percent for four-engine airplanes. It shall be acceptable to include in these data the variation of the airplane's weight along the flight path to take into account the progressive consumption of fuel and oil by the operating engine(s).

(b) *Two engines inoperative.* For airplanes with four engines, the two-engine-inoperative net flight path data shall be determined in such a manner that they represent the airplane's actual climb performance diminished by a gradient of climb equal to 0.5 percent. It

(B) It should be demonstrated that using reverse thrust during a rejected takeoff complies with the engine operating characteristics requirements of § 25.939. The engine should not exhibit any of the adverse engine operating characteristics described in AC 25.939-1, "Evaluating Turbine Engine Operating Characteristics," dated March 19, 1986 (or later revision). The reverse thrust procedures may specify a speed at which the reverse thrust is to be reduced to idle in order to maintain safe engine operating characteristics.

(C) The time sequence for the actions necessary to obtain the recommended level of reverse thrust should be demonstrated by flight test. The time sequence used to determine the accelerate-stop distances should reflect the most critical case relative to the time needed to deploy the thrust reversers. For example, on the airplanes the outboard thrust reversers are locked out if an outboard engine fails. This safety feature prevents the pilot from applying asymmetric reverse thrust on the outboard engines, but it may also delay the pilot's selection of reverse thrust on the operable reversers. In addition, if the selection of reverse thrust is the fourth or subsequent pilot action to stop the airplane (e.g., after manual brake application, thrust/power reduction, and spoiler deployment), a one-second delay should be added to the demonstrated time to select reverse thrust (see Figure 11-1).

(D) The response times of the affected airplane systems to pilot inputs should be taken into account. For example, delays in system operation, such as thrust reverser interlocks that prevent the pilot from applying reverse thrust until the reverser is deployed, should be taken into account. The effects of transient response characteristics, such as reverse thrust engine spin-up, should also be included.

(E) To enable a pilot of average skill to consistently obtain the recommended level of reverse thrust under typical in-service conditions, a lever position that incorporates tactile feedback (e.g., a detent or stop) should be provided. If tactile feedback is not provided, a conservative level of reverse thrust should be assumed.

(F) The applicant should demonstrate that exceptional skill is not required to maintain directional control on a wet runway with a ten-knot crosswind from the most adverse direction. For demonstration purposes, a wet runway may be simulated by using a nosewheel free to caster on a dry runway. Symmetric braking should be used during the demonstration, and both all-engines-operating and critical-engine-inoperative reverse thrust should be considered. The brakes and thrust reversers may not be modulated to maintain directional control. The reverse thrust procedures may specify a speed at which the reverse thrust is reduced to idle in order to maintain directional controllability.

(G) To meet the requirements of §§ 25.101(b)(2) and 25.109(e)(1), the probability of failure to provide the recommended level of reverse thrust should be no greater than 1 per 1000 selections. The effects of any system or component malfunction or failure should not create an additional hazard.

(H) The number of thrust reversers used to determine the wet runway accelerate-stop distance data provided in the AFM should reflect the number of engines assumed to be operating during the rejected takeoff, along with any applicable system design features. The all-engines-operating accelerate-stop distances should be based on all thrust reversers operating. The one-engine-inoperative accelerate-stop distances should be based on failure of the critical engine. For example, if the outboard thrust reversers are locked out when an outboard engine fails, the one-engine-inoperative accelerate stop distances can only include reverse thrust from the inboard engine thrust reversers.

(I) For the engine failure case, it should be assumed that the thrust reverser does not deploy (i.e., no reverse thrust or drag credit for deployed thrust reverser buckets on the failed engine).

(J) For approval of dispatch with one or more inoperative thrust reverser(s), the associated performance information should be provided either in the AFM or the Master Minimum Equipment List.

(K) The effective stopping force provided by reverse thrust in each, or at the option of the applicant, the most critical takeoff configuration, should be demonstrated by flight test. (One method of determining the reverse thrust stopping force would be to compare unbraked runs with and without the use of thrust reversers.) Regardless of the method used to demonstrate the effective stopping force provided by reverse thrust, flight test demonstrations should be conducted using all of the stopping means on which the AFM wet runway accelerate-stop distances are based in order to substantiate the accelerate-stop distances and ensure that no adverse combination effects are overlooked. These demonstrations may be conducted on a dry runway.

(L) For turbopropeller powered airplanes, the criteria of paragraphs (A) through (K) above remain generally applicable. Additionally, the propeller of the inoperative engine should be in the position it would normally assume when an engine fails and the power lever is closed. Reverse thrust may be selected on the remaining engine(s). Unless this selection is achieved by a single action to retard the power lever(s) from the takeoff setting without encountering a stop or lockout, it should be regarded as an additional pilot action for the purposes of assessing delay times. If this action is the fourth or subsequent pilot action to stop the airplane, a one-second delay must be added to the demonstrated time to select reverse thrust.

(VI) Airplane Flight Manual (AFM) wet runway accelerate-stop distances. Section 25.1583(b) requires the operating limitations established under § 25.1533, including wet runway accelerate-stop distances, to be presented in the AFM. At the option of the applicant, grooved and PFC wet runway accelerate-stop distances may also be presented in the AFM, but approval to use these distances is limited to runways that have been designed, constructed, and maintained in a manner acceptable to the FAA Administrator. The page(s) in the AFM containing the wet runway accelerate-stop distances for grooved and PFC runways should contain a note equivalent to the following: "These accelerate-stop distances apply only to runways that are grooved or treated with a porous friction course (PFC) overlay that the operator has determined have been designed, constructed, and maintained in a manner acceptable to the FAA Administrator." Information should also be included describing the method and assumptions used in generating both the smooth and grooved/PFC wet runway information and generally describing the effect of operational variables on wet runway stopping performance (e.g., tire tread depth, runway surface texture, water depth, brakes-on speed).

of 35 feet above the takeoff surface, as determined by a procedure consistent with that established in accordance with section 4T.116.

(b) *Takeoff run.* If the takeoff distance is intended to include a clearway (see item 5 of this regulation), the takeoff run shall be determined and shall be the greater of the distances established in accordance with subparagraphs (1) and (2) of this paragraph.

(1) The horizontal distance along the takeoff path from the start of the takeoff to a point equidistant between the point where the speed V_{LOF} is reached and the point where the airplane attains a height of 35 feet above the takeoff surface, as determined in accordance with section 4T.116.

(2) A distance equal to 115 percent of the horizontal distance along the takeoff path, with all engines operating, from the start of the takeoff to a point equidistant between the point where the speed V_{LOF} is reached and the point where the airplane attains a height of 35 feet above the takeoff surface, as determined by a procedure consistent with that established in accordance with section 4T.116.

4T.117a *Takeoff flight path.*

(a) The takeoff flight path shall be considered to begin at a height of 35 feet above the takeoff surface at the end of the takeoff distance as determined in accordance with section 4T.117(a).

(b) The net takeoff flight path data shall be determined in such a manner that they represent the airplane's actual takeoff flight paths, determined in accordance with section 4T.116 and with paragraph (a) of this section, reduced at each point by a gradient or climb equal to 0.8 percent for two-engine airplanes and equal to 1.0 percent for four-engine airplanes. It shall be acceptable to apply the prescribed reduction in climb gradient as an equivalent reduction in the airplane's acceleration along that portion of the actual takeoff flight path where the airplane is accelerated in level flight.

4T.118 *Climb: general.* Compliance shall be shown with the climb requirements of sections 4T.119 and 4T.120 at all weights, altitudes, and ambient temperatures, within the operational limits established by the applicant for the airplane. The airplane's center of gravity shall be in the most unfavorable position corresponding with the applicable configuration.

4T.119 *All-engine-operating landing climb.* In the landing configuration the steady gradient of climb shall not be less than 3.2 percent, with:

(a) All engines operating at the power and/or thrust which are available 8 seconds after initiation of movement of the power and/or thrust controls from the minimum flight idle to the takeoff position;

(b) A climb speed not in excess of 1.3 V_S

4T.120 *One-engine-inoperative climb.*

(a) *Takeoff: landing gear extended.* In the critical takeoff configuration existing along the flight path between the points where the airplane reaches the speed V_{LOF} and where the landing gear is fully retracted, in accordance with section 4T.116 but without ground effect, the steady gradient of climb shall be positive for two-engine airplanes and shall not be less than 0.5 percent for four-engine airplanes, with:

(1) The critical engine inoperative, the remaining engine(s) operating at the available takeoff power and/or thrust existing in accordance with section 4T.116 at the time retraction of

4T.116 *Takeoff path.* The takeoff path shall be considered to extend from the standing start to a point in the takeoff where a height of 1,500 feet above the takeoff surface is reached or to a point in the takeoff where the transition from the takeoff to the en route configuration is completed and, a speed is reached at which compliance with section 4T.120(c) is shown, whichever point is at a higher altitude. The conditions of paragraphs (a) through (i) of this section shall apply in determining the takeoff path.

- (a) The takeoff path shall be based upon procedures prescribed in accordance with section 4T.111(c).
- (b) The airplane shall be accelerated on the ground to the speed V_1 at which point the critical engine shall be made inoperative and shall remain inoperative during the remainder of the takeoff. Subsequent to attaining speed V_1 , the airplane shall be accelerated to speed V_2 during which time it shall be permissible to initiate raising the nose gear off the ground at a speed not less than the rotating speed V_R .
- (c) Landing gear retraction shall not be initiated until the airplane becomes airborne.
- (d) The slope of the airborne portion of the takeoff path shall be positive at all points.
- (e) The airplane shall attain the speed V_2 prior to reaching a height of 35 feet above the takeoff surface and shall continue at a speed as close as practical to, but not less than, V_2 until a height of 400 feet above the takeoff surface is reached.
- (f) Except for gear retraction and propeller feathering, the airplane configuration shall not be changed before reaching a height of 400 feet above the takeoff surface.
- (g) At all points along the takeoff path starting at the point where the airplane first reaches a height of 400 feet above the takeoff surface, the available gradient of climb shall not be less than 1.2 percent for two-engine airplanes, and 1.7 percent for four-engine airplanes.
- (h) The takeoff path shall be determined either by a continuous demonstrated takeoff, or alternatively, by synthesizing from segments the complete takeoff path.
- (i) If the takeoff path is determined by the segmental method the provisions of subparagraphs (1) through (4) of this paragraph shall be specifically applicable.

(1) The segments of a segmental takeoff path shall be clearly defined and shall be related to the distinct changes in the configuration of the airplane in power and/or thrust and in speed.

(2) The weight of the airplane, the configuration, and the power and/or thrust shall be constant throughout each segment and shall correspond with the most critical condition prevailing in the particular segment.

(3) The segmental flight path shall be based on the airplane's performance without ground effect.

(4) Segmental takeoff path data shall be checked by continuous demonstrated takeoffs up to the point where the airplane's performance is out of ground effect and the airplane's speed is stabilized, to ensure that the segmental path is conservative relative to the continuous path.

NOTE: The airplane usually is considered out of ground effect when it reaches a height above the ground equal to the airplane's wing span.

4T.117 *Takeoff distance and takeoff run.*

(a) *Takeoff distance.* The takeoff distance shall be the greater of the distances established in accordance with subparagraphs (1) and (2) of this paragraph.

(1) The horizontal distance along the takeoff path from the start of the takeoff to the point where the airplane attains a height of 35 feet above the takeoff surface, as determined in accordance with section 4T.116.

(2) A distance equal to 115 percent of the horizontal distance along the takeoff path, with all engines operating, from the start of the takeoff to the point where the airplane attains a height

12. TAKEOFF PATH - § 25.111.

a. Section 25.111(a).

(1) Explanation.

(i) The takeoff path requirements of § 25.111, and the reductions to that path required by § 25.115, are established so that the AFM performance can be used in making necessary decisions relative to takeoff weights when obstacles are present. Such considerations are required by § 121.189 when operations are conducted in accordance with 14 CFR part 121.

(ii) The required performance is provided in AFMs by either pictorial paths at various thrust-to-weight (T/W) conditions, with corrections for wind, or by a series of charts for each segment, along with a procedure for connecting these segments into a continuous path.

(2) Procedures.

(i) Section 25.111(a) requires that the actual takeoff path (from which the AFM net takeoff flight path is derived) extend to the higher of where the airplane is 1,500 ft. above the takeoff surface or to the altitude at which the transition to en route configuration is complete and a speed is reached where compliance with the final segment requirements of § 25.121(c) can be met. Section 25.115(b) allows termination of the AFM "net" flight path below 1,500 ft. in some cases.

(ii) The AFM should contain information required to show compliance with the climb requirements of §§ 25.111 and 25.121(c). This should include information related to the transition from the takeoff configuration and speed to the final segment configuration and speed. The effects of changes from takeoff thrust to maximum continuous thrust should also be included.

(iii) Generally, the AFM shows low T/W takeoff paths ending at 1,500 ft. above the takeoff surface, with acceleration segments between 400 and 1,500 ft., and high T/W takeoff paths extending considerably higher than 1,500 ft. above the takeoff surface. On some airplanes, the takeoff speed schedules, or certain flap configurations, do not require acceleration below 1,500 ft., even at limiting performance gradients. Although § 25.111(a) permits the takeoff path to be terminated as low as 1,500 feet above the takeoff surface, it is recommended that the flight path data, or associated AFM methodology, be presented so that the flight path can be determined to 3,000 ft. above the takeoff surface. This will permit obstacle clearance analysis for distant obstacles of considerable elevation that may be encountered in operations from mountain airports.

(iv) The § 25.115(b) net takeoff flight path, required by § 25.1587(b) to be included in the AFM, need not extend to the altitude specified in § 25.111(a). It may be terminated at a height, generally called "NET HEIGHT," that is directly related to the actual airplane height specified in § 25.111(a). The "NET HEIGHT" is calculated using the actual airplane takeoff climb performance, to the point where the altitude requirements of § 25.111(a) are met, reduced by the climb gradient decrements specified in § 25.115(b).

b. Section 25.111(a)(1)-Takeoff Path Thrust Conditions.

(1) *Explanation.* The takeoff path established from continuous demonstrated takeoffs must at all points represent the actual expected performance, or be conservative, per §§ 25.111(d)(2) and 25.111(d)(4), if the path is constructed by the segmental method.

(2) Procedures.

(i) To be assured that the predicted takeoff path is representative of actual performance, the thrust used in its construction must comply with § 25.101(c). This requires, in part, that the thrust be based on the particular ambient atmospheric conditions that are assumed to exist along the path. The standard lapse rate for ambient temperature is specified in Part 1 of the FAR under "Standard Atmosphere," and should be used for thrust determination associated with each pressure altitude during the climb.

- (ii) In accordance with § 25.111(c)(4), the thrust up to 400 ft. above the takeoff surface must represent the thrust available along the path resulting from the power lever setting established during the initial ground roll in accordance with AFM procedures. This resulting thrust may be less than that available from the rated in-flight setting schedule.
 - (iii) A sufficient number of takeoffs, to at least the altitude above the takeoff surface scheduled for V_2 climb, should be made to establish the fixed power lever thrust lapse. An analysis may be used to account for various engine bleeds (e.g. ice protection, air conditioning, etc.). In some airplanes, the thrust growth characteristics are such that less than full rated thrust must be used for AFM takeoff power limitations and performance. This is to preclude engine limitations from being exceeded during the takeoff climbs to 400 ft. above the takeoff surface.
 - (iv) Engine thrust lapse with speed and altitude during the takeoff and climb, at fixed power lever settings, can be affected by takeoff pressure altitude.
 - (v) Most turbine engines are sensitive to crosswind or tailwind conditions, when setting takeoff power under static conditions, and may stall or surge. To preclude this problem, it is acceptable to establish a rolling takeoff thrust setting procedure, provided the AFM takeoff field length and the takeoff thrust setting charts are based on this procedure. Demonstrations and analyses have been accepted in the past showing a negligible difference in distance between static and rolling takeoffs. A typical test procedure is as follows:
 - (A) After stopping on the runway, set an intermediate power on all engines (power setting selected by applicant).
 - (B) Release brakes and advance power levers.
 - (C) Set target power setting as rapidly as possible prior to reaching 60 to 80 knots.
 - (D) No adverse engine operating characteristics should exist after completion of the power setting through the climb to 1,500 ft. above the airport and attainment of the en route configuration. Tests should be conducted to determine if any engine operating problems exist for takeoffs conducted throughout the altitude range for which takeoff operations are to be scheduled in the AFM.
 - (iv) If the applicant wishes to use a different procedure, it should be evaluated and, if found acceptable, the procedure should be reflected in the AFM.
- c. Section 25.111(a)(2) - Engine Failure.
- (1) Explanation.
 - (i) Since the regulations cannot dictate what type of engine failures may actually occur, it could be assumed that the engine failure required by the regulation occurs catastrophically. Such a failure would cause the thrust to drop immediately, with the associated performance going from all-engines-operating to one-engine-inoperative at the point of engine failure.
 - (ii) This conservative rationale notwithstanding, there is a basis for assuming that the failed engine thrust will not decay immediately. Unlike reciprocating engines, the locking-up of a jet engine fan without causing the engine to separate from the airplane is highly unlikely. Separation of the engine or fan, or fan disintegration, would remove weight and/or the ram drag included in the engine inoperative performance, providing compensation for the immediate thrust loss.
 - (iii) With these considerations, it may be acceptable to use the transient thrust as the failed engine spools down at V_{E1} . The thrust time-history used for data reduction and expansion should be substantiated by test results.
 - (iv) In the case of propeller-driven airplanes, consideration should also be given to the position of the failed engine's propeller during the engine failure. These airplanes typically incorporate an automatic system to drive the propeller to a low drag position when an engine fails. The loss of thrust in this case will be much more sudden than the turbojet engine spooldown described above.

NOTE: In certain cases, ground takeoff tests might involve some takeoffs at the V_{MU} speeds.

(e) The rotation speed V_R , in terms of calibrated air speed, shall be selected by the applicant in compliance with the conditions of subparagraphs (1) through (4) of this paragraph.

(1) The V_R speed shall not be less than:

(i) The speed V_1 ;

(ii) A speed equal to 105 percent of V_{MC}

(iii) A speed which permits the attainment of the speed V_2 prior to reaching a height of 35 feet above the takeoff surface as determined in accordance with section 4T.116(e);

(iv) A speed which, if the airplane is rotated at its maximum practicable rate, will result in a lift-off speed V_{LOF} (see paragraph (f) of this section) not less than 110 percent of V_{MU} in the all-engines-operating condition nor less than 105 percent of V_{MU} in the one-engine-inoperative condition.

(2) For any given set of conditions (weight, configuration, temperature, etc.), a single value of V_R speed obtained in accordance with this paragraph shall be used in showing compliance with both the one-engine-inoperative and the all-engines-operating takeoff provisions.

(3) It shall be shown that the one-engine-inoperative takeoff distance determined with a rotation speed 5 knots less than the V_R speed established in accordance with subparagraphs (1) and (2) of this paragraph does not exceed the corresponding one-engine-inoperative takeoff distance determined with the established V_R speed. The determination of the takeoff distances shall be in accordance with section 4T.117(a) (1).

(4) It shall be demonstrated that reasonably expected variations in service from the takeoff procedures established by the applicant for the operation of the airplane (See sec. 4T.111(c)) (e.g., over-rotation of the airplane, out of trim conditions) will not result in unsafe flight characteristics nor in marked increases in the scheduled takeoff distances established in accordance with section 4T.117(a).

(f) The lift-off speed V_{LOF} , in terms of calibrated air speed, shall be the speed at which the airplane first becomes airborne.

4T.115 Accelerate-stop distance.

(a) The accelerate-stop distance shall be the sum of the following:

(1) The distance required to accelerate the airplane from a standing start to the speed V_1 ;

(2) Assuming the critical engine to fail at the speed V_1 , the distance required to bring the airplane to a full stop from the point corresponding with the speed V_1 .

(b) In addition to, or in lieu of, wheel brakes, the use of other braking means shall be acceptable in determining the accelerate-stop distance, provided that such braking means shall have been proven to be safe and reliable, that the manner of their employment is such that consistent results can be expected in service and that exceptional skill is not required to control the airplane.

(c) The landing gear shall remain extended throughout the accelerate-stop distance.

(d) If the accelerate-stop distance is intended to include a stop-way with surface characteristics substantially different from those of a smooth hard-surfaced runway, the takeoff data shall include operational correction factors for the accelerate-stop distance to account for the particular surface characteristics of the stopway and the variations in such characteristics with seasonal weather conditions (i.e., temperature, rain, snow, ice, etc.), within the operational limits established by the applicant.

4T.113 *Takeoff: general.*

(a) The takeoff data in sections 4T.114 through 4T.117 shall be determined under the conditions of subparagraphs (1) and (2) of this paragraph.

(1) At all weights, altitudes, and ambient temperatures, within the operational limits established by the applicant for the airplane.

(2) In the configuration for takeoff (see sec. ~T.111).

(b) Takeoff data shall be based on a smooth, dry, hard-surfaced runway and shall be determined in such a manner that reproduction of the performance does not require exceptional skill or alertness on the part of the pilot. In the case of seaplanes or floatplanes, the takeoff surface shall be smooth water, while for skiplanes it shall be smooth, dry snow. In addition, the takeoff data shall include operational correction factors in accordance with subparagraphs (1) and (2) of this paragraph for wind and for runway gradients, within the operational limits established by the applicant for the airplane.

(1) Not more than 50 percent of nominal wind components along the takeoff path opposite to the direction of takeoff, and not less than 150 percent of nominal wind components along the takeoff path in the direction of takeoff.

(2) Effective runway gradients.

4T.114 *Takeoff speeds.*

(a) The critical-engine-failure speed V_1 in terms of calibrated air speed, shall be selected by the applicant, but shall not be less than the minimum speed at which controllability by primary aerodynamic controls alone is demonstrated during the takeoff run to be adequate to permit proceeding safely with the takeoff using average piloting skill, when the critical engine is suddenly made inoperative.

(b) The minimum takeoff safety speed V_{2min} , in terms of calibrated air speed, shall not be less than:

(1) 1.2 V_S for two-engine propeller-driven airplanes and for airplanes without propellers which have no provisions for obtaining a significant reduction in the one-engine-inoperative power-on stalling speed;

(2) 1.15 V_S for propeller-driven airplanes having more than two engines and for airplanes without propellers which have provisions for obtaining a significant reduction in the one-engine-inoperative power-on stalling speed;

(3) 1.10 times the minimum control speed V_{MC} .

(c) The takeoff safety speed V_2 , in terms of calibrated air speed, shall be selected by the applicant so as to permit the gradient of climb required in section 4T.120(b), but it shall not be less than:

(1) The speed V_{2min}

(2) The rotation speed V_R (see paragraph (e) of this section) plus the increment in speed attained prior to reaching a height of 35 feet above the takeoff surface in compliance with section 4T.116(e).

(d) The minimum unstick speed V_{MU} , in terms of calibrated air speed, shall be the speed at and above which the airplane can be made to lift off the ground and to continue the takeoff without displaying any hazardous characteristics. V_{MU} speeds shall be selected by the applicant for the all-engines-operating and the one-engine-inoperative conditions. It shall be acceptable to establish the V_{MU} speeds from free air data: *Provided*, That these data are verified by ground takeoff tests.

(2) Procedures.

(i) For turbopropeller-powered airplanes, if transient thrust credit is used during engine failure in determining the accelerate-go AFM performance, sufficient tests should be conducted using actual fuel cuts to establish the thrust decay as contrasted to idle engine cuts. For derivative programs not involving a new or modified engine type (i.e., a modification that would affect thrust decay characteristics), fuel cuts are unnecessary if thrust decay characteristics have been adequately substantiated.

(ii) For propeller-driven airplanes, the use of fuel cuts can be more important in order to ensure that the takeoff speeds and distances are obtained with the critical engine's propeller attaining the position it would during a sudden engine failure. The number of tests that should be conducted using fuel cuts, if any, depends on the correlation obtained with the idle cut data and substantiation that the data analysis methodology adequately models the effects of a sudden engine failure.

d. Section 25.111(a)(3) - Airplane Acceleration.

(1) Explanation. None.

(2) Procedures. None.

e. Section 25.111(b) - Airplane Rotation and Gear Retraction.

(1) Explanation. The rotation speed, V_{R} , is intended to be the speed at which the pilot initiates action to raise the nose gear off the ground during the acceleration to V_2 . Consequently, the takeoff path, determined in accordance with §§ 25.111(a) and (b), should assume that pilot action to raise the nose gear off the ground will not be initiated until the speed V_R has been reached.

(2) Procedures. The time between liftoff and initiation of gear retraction should not be less than that necessary to establish an indicated positive rate of climb plus one second.

f. Section 25.111(c)(1) - Takeoff Path Slope.

(1) Explanation.

(i) The establishment of a horizontal segment, as part of the takeoff flight path, is considered to be acceptable, per § 25.115(c), for showing compliance with the positive slope required by § 25.111(c)(1).

(ii) The net takeoff flight path is the flight path used to determine the airplane obstacle clearance for turbine powered airplanes (§ 121.189(d)(2)). Section 25.115(b) states the required climb gradient reduction to be applied throughout the flight path for the determination of the net flight path, including the level flight acceleration segment. Rather than decreasing the level flight path by the amount required by § 25.115(b), § 25.115(c) allows the airplane to maintain a level net flight path during acceleration, but with a reduction in acceleration equal to the gradient decrement required by § 25.115(b). By this method, the applicant exchanges altitude reduction for increased distance to accelerate in level flight in determination of the level flight portion of the net takeoff path.

(2) Procedures.

(i) The level acceleration segment in the AFM net takeoff profile should begin at the same horizontal distance along the takeoff flight path that the climb segment, without the gradient reductions of § 25.115(b), reaches the AFM specified acceleration height.

(ii) The AFM acceleration height should be presented in terms of pressure altitude increment above the takeoff surface. This information should allow the establishment of the pressure altitude "increment" (Δh_p) for off-standard ambient temperatures so that the geometric height required for obstacle clearance is assured. For example:

Given:

- o Takeoff surface pressure altitude (h_p) = 2,000 ft.
- o Airport std. temp. abs. (T_S) = $11^{\circ}\text{C} + 273.2^{\circ} = 284.2^{\circ}\text{K}$
- o Airport ambient temp. abs. (T_{AM}) = $-20^{\circ}\text{C} + 273.2^{\circ} = 253.2^{\circ}\text{K}$
- o Geometric height required (h_h) = 1,700 ft. above the takeoff surface

Find:

- o Pressure altitude increment (Δh_p) above the takeoff surface
 $\Delta h_p = \Delta h(T_S/T_{AM}) = 1,700 \text{ ft. } (284.2^{\circ}\text{K}/253.2^{\circ}\text{K})$
 $\Delta h_p = 1,908 \text{ ft.}$

g. Section 25.111(c)(2) - Takeoff Path Speed.

- (1) Explanation.
 (i) It is intended that the airplane be flown at a constant indicated airspeed to at least 400 ft. above the takeoff surface. This speed must meet the constraints on V₂ of §§ 25.107(b) and (c).

(ii) The specific wording of § 25.111(c)(2) should not be construed to imply that above 400 ft. the airspeed may be reduced below V₂, but instead that acceleration may be commenced.

(2) Procedures.

(i) For those airplanes that take advantage of reduced stall speeds at low pressure altitude, the scheduling of V₂ should not be factored against the stall speed obtained at the takeoff surface pressure altitude. Such a procedure would result in a reduced stall speed margin during the climb, which would be contrary to the intent of § 25.107(b).

(ii) For those airplanes mentioned in paragraph (i), above, the V₂ should be constrained in addition to the requirements of §§ 25.107(b) and (c), by the stall speed 1,500 ft. above the takeoff surface. Weight reduction along the takeoff path, due to fuel burn, may be considered in the calculation of the stall speed ratios, provided it is well established. However, many applicants have measured stall speeds at 10,000 to 15,000 ft., which provides stall margin conservatism at lower takeoff field pressure altitudes.

h. Section 25.111(c)(3) - Required Gradient.

(1) Explanation. None.

(2) Procedures. None.

i. Section 25.111(c)(4) - Configuration Changes.

(1) Explanation.

(i) The intent of this requirement is to permit only those crew actions that are conducted routinely to be used in establishing the one-engine-inoperative takeoff path. The power levers may only be adjusted early during the takeoff roll, as discussed in paragraph 12b(2), and then left fixed until at least 400 ft. above the takeoff surface.

(ii) Simulation studies and accident investigations have shown that when heavy workload occurs in the cockpit, as with an engine failure during takeoff, the crew might not advance the operative engines to avoid the ground, even if the crew knows the operative engines have been set at reduced power. This same finding applies to manually feathering a propeller. The landing gear may be retracted, however, as this is accomplished routinely once a positive rate of climb is observed. This also establishes the delay time to be used for data expansion purposes.

- (1) The Administrator shall find that the procedures can be consistently executed in service by crews of average skill.
- (2) The procedures shall not involve methods or the use of devices which have not been proven to be safe and reliable.
- (3) Allowance shall be made for such time delays in the execution of the procedures as may be reasonably expected to occur during service.

4T.112 Stalling and minimum control speed.

(a) The speed V_S shall denote the calibrated stalling speed or the minimum steady flight speed at which the airplane is controllable, in knots, with:

- (1) Zero thrust at the stalling speed or engines idling and throttles closed if it is shown that the resultant thrust has no appreciable effect on the stalling speed;
- (2) If applicable, propeller pitch controls in the position necessary for compliance with subparagraph (1) of this paragraph; the airplane in all other respects (flaps, landing gear, etc.) in the particular configuration corresponding with that in connection with which V_S is being used;
- (3) The weight of the airplane equal to the weight in connection with which V_S is being used to determine compliance with a particular requirement;
- (4) The center of gravity in the most unfavorable position within the allowable range.

(b) The stall speed defined in this section shall be the minimum speed obtained in flight tests conducted in accordance with the procedure of subparagraphs (1) and (2) of this paragraph.

(1) With the airplane trimmed for straight flight at a speed chosen by the applicant, but not less than 1.2 V_S nor greater than 1.4 V_S and from a speed sufficiently above the stalling speed to ensure steady conditions, the elevator control shall be applied at a rate such that the airplane speed reduction does not exceed 1 knot per second.

(2) During the test prescribed in subparagraph (1) of this paragraph, the flight characteristics provisions of section 4b.160 of Part 4b of the Civil Air Regulations shall be complied with.

(c) The minimum control speed V_{MC} in terms of calibrated air speed, shall be determined under the conditions specified in this paragraph so that, when the critical engine is suddenly made inoperative at that speed, it is possible to recover control of the airplane with the engine still inoperative and to maintain it in straight flight at that speed, either with zero yaw or, at the option of the applicant, with an angle of bank not in excess of 5 degrees. V_{MC} shall not exceed 1.2 V_S with:

- (1) Engines operating at the maximum available takeoff thrust and/or power;
- (2) Maximum sea level takeoff weight or such lesser weight as might be necessary to demonstrate V_{MC}.

(3) The airplane in the most critical takeoff configuration existing along the flight path after the airplane becomes airborne, except that the landing gear is retracted;

- (4) The airplane trimmed for takeoff;
- (5) The airplane airborne and the ground effect negligible;
- (6) The center of gravity in the most unfavorable position;
- (d) In demonstrating the minimum speed specified in paragraph (c) of this section, the rudder force required to maintain control shall not exceed 180 pounds and it shall not be necessary to reduce the power and/or thrust of the operative engine(s).

(e) During recovery from the maneuver specified in paragraph (c) of this section, the airplane shall not assume any dangerous attitude, nor shall it require exceptional skill, strength, or alertness on the part of the pilot to prevent a change of heading in excess of 20 degrees before recovery is complete.

comply with the following requirements. Applicants for a type certificate for a turbine-powered transport category airplane may elect and are authorized to meet the requirements of this Special Civil Air Regulation prior to August 29, 1959, in which case however, all of the following provisions must be complied with.

1. The provisions of Part 4b of the Civil Air Regulations, effective on the date of application for type certificate; and such of the provisions of all subsequent amendments to Part 4b, in effect prior to August 27, 1957, as the Administrator finds necessary to ensure that the level of safety of turbine-powered airplanes is equivalent to that generally intended by Part 4b.

2. In lieu of sections 4b.110 through 4b.125, 4b.183, and 4b.743 of Part 4b of the Civil Air Regulations, the following shall be applicable:

PERFORMANCE

4T.110 General.

(a) The performance of the airplane shall be determined and scheduled in accordance with, and shall meet the minima prescribed by, the provision of sections 4T.110 through 4T.123. The performance limitations, information and other data shall be given in accordance with section 4T.743.

(b) Unless otherwise specifically prescribed, the performance shall correspond with ambient atmospheric conditions and still air. Humidity shall be accounted for as specified in paragraph (c) of this section.

(c) The performance as affected by engine power and, or thrust shall be based on a relative humidity of 80 percent at and below standard temperatures and on 34 percent at and above standard temperatures plus 50° F. Between these two temperatures the relative humidity shall vary linearly.

(d) The performance shall correspond with the propulsive thrust available under the particular ambient atmospheric conditions, the particular flight condition, and the relative humidity specified in paragraph (c) of this section. The available propulsive thrust shall correspond with engine power and/or thrust not exceeding the approved power and/or thrust less the installation losses and less the power and or equivalent thrust absorbed by the accessories and services appropriate to the particular ambient atmospheric conditions and the particular flight condition.

4T.111 Airplane configuration, speed, power, and/or thrust; general.

(a) The airplane configuration (setting of wing and cowl flaps, air brakes, landing gear, propeller, etc.), denoted respectively as the take-off, en route, approach, and landing configurations, shall be selected by the applicant except as otherwise prescribed.

(b) It shall be acceptable to make the airplane configurations variable with weight, altitude, and temperature to an extent found by the Administrator to be compatible with operating procedures required in accordance with paragraph (c) of this section.

(c) In determining the accelerate-stop distances, takeoff flight paths, takeoff distances, and landing distances, changes in the airplane's configuration and speed, and in the power and thrust shall be in accordance with procedures established by the applicant for the operation of the airplane in service, except as otherwise prescribed. In addition, procedures shall be established for the execution of balked landings and missed approaches associated with the conditions prescribed in sections 4T.119 and 4T.120(d), respectively. All procedures shall comply with the provisions of subparagraphs (1) through (3) of this paragraph.

(2) Procedures.

(i) To permit the takeoff to be conducted using less than rated power, automatic power advance devices have been approved. These devices are addressed in § 25.904, and the related performance requirements are described in Appendix I to Part 25 of the FAR.

(ii) To permit the takeoff to be based on a feathered propeller up to 400 ft. above the takeoff surface, automatic propeller feathering devices have been approved. Guidance related to performance credit for automatic propeller feathering devices, below 400 feet above the takeoff surface, is presented in paragraph 2.41 of this AC.

(iii) Drag reduction for a manually feathered propeller is permitted for flight path calculations only after reaching 400 ft. above the takeoff surface.

j. Section 25.111(d) - Takeoff Path Construction.

(1) **Explanation.** This regulation should not be construed to mean that the takeoff path be constructed entirely from a continuous demonstration or entirely from segments. To take advantage of ground effect, typical AFM takeoff paths utilize a continuous takeoff path from V_L or to the gear up point, covering the range of thrust-to-weight ratios. From that point free air performance, in accordance with § 25.111(d)(2), is added segmentally. This methodology may yield an AFM flight path that is steeper with the gear down than up.

(2) **Procedures.** The AFM should include the procedures necessary to achieve this performance.

k. Section 25.111(d)(1) - Takeoff Path Segment Definition.

(1) **Explanation.** None.

(2) **Procedures.** None.

l. Section 25.111(d)(2) - Takeoff Path Segment Conditions.

(1) **Explanation.** The subject paragraph states "The weight of the airplane, the configuration, and the power or thrust setting must be constant throughout each segment and must correspond to the most critical condition prevailing in the segment." The intent is that, for simplified analysis, the performance must be based on that value available at the most critical point in time during the segment, not that the individual variables (weight, approximate thrust setting, etc.) should each be picked at their most critical value and then combined to produce the performance for the segment.

(2) **Procedures.** The performance during the takeoff path segments should be obtained using one of the following methods:

(i) The critical level of performance as explained in paragraph (1);

(ii) The average performance during the segment; or

(iii) The actual performance variation during the segment.

m. Section 25.111(d)(3) - Segmented Takeoff Path Ground Effect.

(1) **Explanation.** This requirement does not intend the entire flight path to necessarily be based upon out-of-ground-effect performance simply because the continuous takeoff demonstrations have been broken into sections for data reduction expediency. For example, if the engine inoperative acceleration from V_{EF} to V_R is separated into a thrust decay portion and a windmilling drag portion, the climb from 35 ft. to gear up does not necessarily need to be based upon out-of-ground-effect performance. (Also see explanation under § 25.111(d) in paragraph 12j(1) of this AC.)

- (2) Procedures. None
- n. Section 25.111(d)(4) - Segmented Takeoff Path Check
 - (1) Explanation. None.
 - (2) Procedures. If the construction of the takeoff path from brake release to out-of-ground-effect contains any portions that have been segmented (e.g., airplane acceleration segments with all-engines-operating and one-engine-inoperative), the path should be checked by continuous demonstrated takeoffs. A sufficient number of these, employing the AFM established takeoff procedures and speeds and covering the range of thrust-to-weight ratios, should be made to ensure the validity of the segmented takeoff path. The continuous takeoff data should be compared to takeoff data calculated by AFM data procedures but using test engine thrusts and test speeds.
- o. Section 25.111(e) - Flight Path with Standby Power Rocket Engines (RESERVED).

*13. TAKEOFF DISTANCE AND TAKEOFF RUN - § 25.113.

- a. Takeoff Distance on a Dry Runway - § 25.113(a)
 - (1) The takeoff distance on a dry runway is the greater of the two distances depicted in (i) or (ii) below. The distances indicated below are measured horizontally from the main landing gears at initial brake release to that same point on the airplane when the lowest part of the departing airplane is 35 ft. above the surface of the runway.
 - (i) The distance measured to 35 ft. with a critical engine failure occurring at V_{EF} as shown in Figure 13-1.*

the specific reduction of the net flight path gradient to a value of 0.8 percent. Correlatively, a reevaluation of the climb gradients for twin-engine airplanes in the second segment takeoff and in the approach climb indicates that the respective values should be 2.4 percent and 2.1 percent and these changes are being made in 4T.120 (b) and (d).

A change is introduced in the conditions prescribed for meeting the climb gradient in the first segment takeoff climb (4T.120(a)), by changing the speed V_2 to the speed V_{LOF} . The intent of this requirement is to use the speed at which the airplane lifts off the ground. In SR-422 this speed was considered to be V_2 ; however, in SR-422A and in this regulation the speed V_2 is a higher speed which is reached at the end of the takeoff distance and no longer reflects the conditions pertinent to the first segment climb. In making this change consistent with relevant changes in SR-422A and in this regulation, no consideration has been given to the appropriateness of the minimum climb gradient values prescribed for the first segment climb. These are subject to alteration if results of further studies so indicate.

There is being introduced in this regulation the concept of "stopways," the definition of which is contained in item 5(b). Stopways have been used outside the United States in meeting the accelerate-stop distances in case of aborted takeoffs. They are considered to result in more practical operations. In order to ensure that they can be used without detrimental effects on safety, a provision is being included in 4T.115(d) requiring taking into account the surface characteristics of the stopways to be used in scheduling the accelerate-stop distances in the Airplane Flight Manual.

In conjunction with the introduction of stopways, there are changes being made in the definition of a "clearway" (item 5(a)). One of the changes is to specify that a clearway begins at the end of the runway whether or not a stopway is being used. Of the other changes, the most significant one expresses the clearway in terms of a clearway plane and permits this plane to have an upward slope of 1.25 percent. In effect, this change will allow, in some cases, use of clearways which would not be allowed under the definition in SR-422A because of relatively small obstacles or slightly sloping terrain. (See also 40T.81(C) and 43T.11(C).)

There are also included in this regulation a number of minor, editorial, or clarifying changes.

Draft Release No. 58-1C included a proposal for expanding lateral obstacle clearances in the takeoff flight path. Studies indicate that some expanding lateral clearances are necessary for safety in operations with all turbine-powered airplanes. It appears, therefore, that an appropriate rule should be made applicable not only to airplanes certificated in accordance with this regulation, but also to those certificated in accordance with SR-422 and SR-422A. Accordingly, no change is being made in this regulation to the lateral obstacle clearance provisions, instead, a Notice of Proposed Rule Making is now being prepared to amend SR-422, SR-422A, and this regulation, to require expanding lateral obstacle clearances for all airplanes certificated thereunder.

This Special Civil Air Regulation is not intended to compromise the authority of the Administrator under section 4b.10 to impose such special conditions as are found necessary in any particular case to avoid unsafe design features and otherwise to ensure equivalent safety.

Interested persons have been afforded an opportunity to participate in the making of this regulation (24 F.R. 128), and due consideration has been given to all relevant matter presented.

This regulation does not require compliance until after August 29, 1959; however, since applicants for a type certificate for turbine-powered transport category airplanes may elect to show compliance with this regulation before that date, it is being made effective immediately.

In consideration of the foregoing, the following Special Civil Air Regulation is hereby promulgated to become effective immediately:

Contrary provisions of the Civil Air Regulations notwithstanding, all turbine-powered transport category airplanes for which a type certificate is issued after August 29, 1959, shall

SPECIAL CIVIL AIR REGULATION NO. SR-422B

Effective: July 9, 1959
 Issued: July 9, 1959

Turbine Powered Transport Category Airplane of Current Design

Special Civil Air Regulation No. SR-422, effective August 27, 1957, prescribes requirements applicable to the type certification and operation of turbine-powered transport category airplanes for which a type certificate is issued after August 27, 1957. Special Civil Air Regulation No. SR-422A, effective July 2, 1958, included substantive changes to SR-422 and was made applicable to all turbine-powered transport category airplanes for which a type certificate is issued after September 30, 1958.

This Special Civil Air Regulation makes further changes to the airworthiness rules for turbine-powered transport category airplanes to be applicable to all such airplanes for which a type certificate is issued after August 29, 1959. These changes were proposed in Draft Release No. 58-1 C (24 F.R. 128) by the Civil Aeronautics Board in connection with the 1958 Annual Airworthiness Review. The amendments herein have been adopted after careful consideration of all the discussion and comment received thereon.

Substantive and minor changes have been made to the provisions of SR-422A. For ease in identification they are listed as follows:

- (a) Substantive changes: introductory paragraphs; 4T.114 (b), (c), (d), (e), and (f); 4T.115(d); 4T.117a(b); 4T.120(a)(3), (b), and (d); 40T.81(c); 43T.11(c); and item 5 (a) and (b).
- (b) Minor changes; item 2; 4T.112 (title), (b)(1), (c), (d), and (e); 4T.113(b); 4T.116(i)(4); 4T.117(b) (1) and (2); 4T.120(a); 4T.121; 4T.122(d); 4T.123(a); 40T.82; and 40T.83.

Pertinent background information to this regulation is contained in the preambles to SR-422 and SR-422A. Following is a discussion of important issues relevant to the changed provisions contained herein.

One of the most important changes being introduced concerns the rotation speed V_R of the airplane during takeoff (4T.114). Experience gained in the certification of airplanes under the provisions of SR-422 and SR-422A indicates that relating V_R to the stall speed is not essential and might unduly penalize airplanes with superior flying qualities. It has been found that the primary limitations on V_R should be in terms of a margin between the actual lift-off speeds V_{LOF} and the minimum unstick speed V_{MU} at which the airplane can proceed safely with the takeoff. The provisions contained herein require that V_R speeds be established to be applicable to takeoffs with one engine inoperative as well as with all engines operating. The V_{MU} speeds can be established from free air data provided that the data are verified by ground takeoff tests. Certain safeguards are included in conjunction with the establishment of V_R speeds to ensure that takeoffs in service can be made with consistent safety.

A change is being introduced to the provision in 4T.117a(b) concerning the manner in which the net takeoff flight path is obtained. In accordance with this provision as contained in SR-422A, the net takeoff flight path would have a negative slope throughout the acceleration segment. Since this segment usually represents level flight easily controlled by reference to the normal flight instruments, a significant reduction in the flight path's gradient would not be expected. For these reasons, the provision is being changed to permit an equivalent reduction in acceleration in lieu of a reduction in gradient.

Section 4T.117a(b) is being amended additionally by changing the value of gradient margin in the net flight path for two-engine airplanes from 1.0 percent to 0.8 percent. The value for four engine airplanes remains 1.0 percent. Differentiation in gradient values in the net flight path between two and four-engine airplanes is consistent with the differentiation in the climb gradients for the takeoff, enroute, and approach stages of flight. Statistical analysis substantiates

FIGURE 13-1. TAKEOFF DISTANCE ON A DRY RUNWAY

Critical Engine Fails at V_{CR}

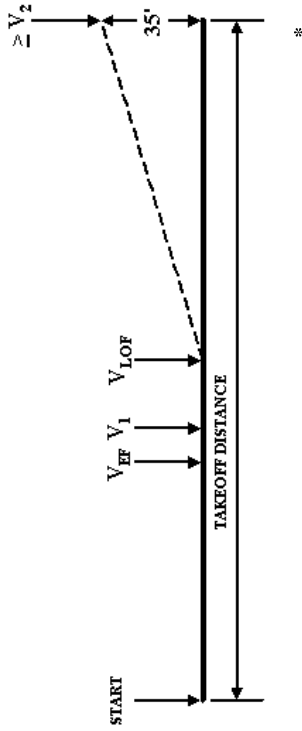

(ii) One hundred fifteen (115) percent of the distance measured to the 35 ft. height above the takeoff surface with all-engines-operating as shown in Figure 13-2. In establishing the all-engines-operating takeoff distance, § 25.113(a)(2) requires the distance to be "...determined by a procedure consistent with § 25.111" (Takeoff Path). The interpretation of this statement is that the all-engines-operating takeoff distance should:

- (A) Be based on the airplane reaching a speed of V_2 before it is 35 feet above the takeoff surface; and
- (B) Be consistent with the achievement of a smooth transition to the steady initial climb speed at a height of 400 feet above the takeoff surface.

(2) The takeoff procedure adopted should be reflected in the takeoff distance.

FIGURE 13-2. TAKEOFF DISTANCE (All-Engines-Operating)

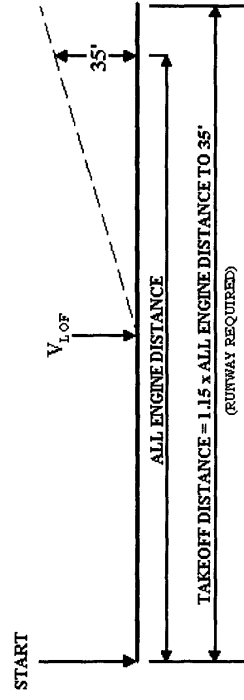

* b. Takeoff Distance on a Wet Runway - § 25.113(b).

(1) The takeoff distance on a wet runway is the greater of the takeoff distance on a dry runway (using the dry runway V_1 speed), determined in accordance with paragraphs 1.3a(1)(i) and (ii) of this AC, or the distance on a wet runway using a reduced screen height (and the wet runway V_1 speed) as described in paragraph (2), below.

- (2) The takeoff distance on a wet runway is determined as the horizontal distance the main landing gear travels from brake release to the point where the lowest part of the airplane is 15 ft. above the takeoff surface. The airplane must attain a height of 15 ft. above the takeoff surface before reaching the end of the runway in a manner that will allow V_2 to be achieved before reaching a height of 35 ft. above the takeoff surface as shown in Figure 13-3.

FIGURE 13-3. TAKEOFF DISTANCE ON A WET RUNWAY

Critical Engine Failure at V_{EF}

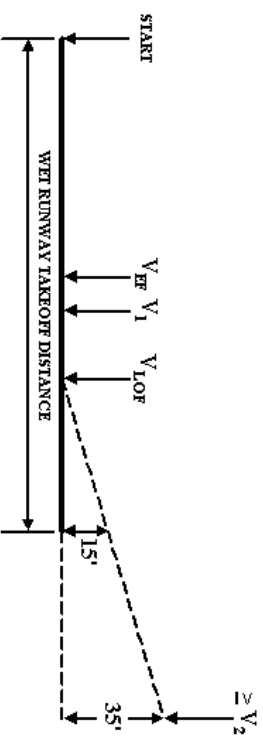

c. **Takeoff Run - § 25.113(c).**

(1) Takeoff run is a term used for the runway length when the takeoff distance includes a clearway (i.e., where the accelerate-go distance does not remain entirely over the runway), and the takeoff run is either of the two distances depicted in (i) or (ii) below, whichever is greater. These distances are measured as described in § 25.113(a). When using a clearway to determine the takeoff run, no more than one-half of the air distance from V_{LOF} to V_{S} may be flown over the clearway.

(i) The distance from the start of the takeoff roll to the mid-point between lift-off and the point at which the airplane attains a height of 35 ft. above the takeoff surface, with a critical engine failure occurring at V_{EF} as shown in Figure 13-4. For takeoff on a wet runway, the takeoff run is equal to the takeoff distance (i.e., there is no clearway credit allowed on a wet runway)*

(a) No airplane shall be taken off at a weight which exceeds the take-off weight specified in the Airplane Flight Manual for the elevation of the airport and for the ambient temperature existing at the time of the take-off. (See secs. 4T.123(a) (1) and 4T.743(a).)

(b) No airplane shall be taken off at a weight such that, allowing for normal consumption of fuel and oil in flight to the airport of destination and to the alternate airports, the weight on arrival will exceed the landing weight specified in the Airplane Flight Manual for the elevation of each of the airports involved and for the ambient temperatures anticipated at the time of landing. (See secs. 4T.123(a) (2) and 4T.743(a).)

(c) No airplane shall be taken off at a weight which exceeds the weight shown in the Airplane Flight Manual to correspond with the minimum distances required for take-off. These distances shall correspond with the elevation of the airport, the runway to be used, the effective runway gradient, and the ambient temperature and wind component existing at the time of take-off. (See secs. 4T.123(a)(3) and 4T.743(a).) If the take-off distance includes a clearway as defined in Item 5 of this regulation, the take-off distance shall not include a clearway distance greater than one-half of the take-off run.

(d) No airplane shall be operated outside the operational limits specified in the Airplane Flight Manual. (See secs. 4T.123(a) (4) and 4T.743(a).)

5. The following definitions shall apply:

Clearway. A clearway is an area beyond the airport runway not less than 300 feet on either side of the extended center line of the runway, at an elevation no higher than the elevation at the end of the runway, clear of all fixed obstacles, and under the control of the airport authorities.

(1) No place along the intended track shall be more than 90 minutes away from an airport at which a landing can be made in accordance with the provisions of section 40T.84(b), assuming all engines to be operating at cruising power.

(2) No airplane shall be taken off at a weight in excess of that which, according to the two-engine-inoperative en route net flight path data shown in the Airplane Flight Manual, will permit the airplane to continue flight from the point where two engines are assumed to fail simultaneously to an airport where a landing can be made in accordance with the provisions of section 40T.84(b), the net flight path having a positive slope at an altitude of at least 1,000 feet above all terrain and obstructions along the route within 5 miles on either side of the intended track or at an altitude of 2,000 feet, whichever is higher. The net flight path considered shall be for the ambient temperatures anticipated along the route. The provisions of subdivisions (i) through (iii) of this subparagraph shall apply. (See secs. 4T.123(b) and 4T.743(b).)

(i) The two engines shall be assumed to fail at the most critical point along the route.

(ii) The airplane's weight at the point where the two engines are assumed to fail shall be considered to be not less than that which would include sufficient fuel to proceed to the airport and to arrive there at an altitude of at least 1,500 feet directly over the landing area and thereafter to fly for 15 minutes at cruise power and/or thrust

(iii) The consumption of fuel and oil after the engines become inoperative shall be that which is accounted for in the net flight path data shown in the Airplane Flight Manual.

40T.84 Landing limitations.

(a) *Airport of destination.* No airplane shall be taken off at a weight in excess of that which, in accordance with the landing distances shown in the Airplane Flight Manual for the elevation of the airport of intended destination and for the wind conditions anticipated there at the time of landing, would permit the airplane to be brought to rest at the airport of intended destination within 60 percent of the effective length of the runway from a point 50 feet directly above the intersection of the obstruction clearance plane and the runway. The weight of the airplane shall be assumed to be reduced by the weight of the fuel and oil expected to be consumed in flight to the airport of intended destination. Compliance shall be shown with the conditions of subparagraphs (1) and (2) of this paragraph. (See secs. 4T.123(b) and 4T.743(b).)

(1) It shall be assumed that the airplane is landed on the most favorable runway and direction in still air.

(2) It shall be assumed that the airplane is landed on the most suitable runway considering the probable wind velocity and direction and taking due account of the ground handling characteristics of the airplane and of other conditions (i.e., landing aids, terrain, etc.). If full compliance with the provisions of this subparagraph is not shown, the airplane may be taken off if an alternate airport is designated which permits compliance with paragraph (b) of this section.

(b) *Alternate airport.* No airport shall be designated as an alternate airport in a dispatch release unless the airplane at the weight anticipated at the time of arrival at such airport can comply with the provisions of paragraph (a) of this section, provided that the airplane can be brought to rest within 70 percent of the effective length of the runway.

4. In lieu of section 43.11 of Part 43 of the Civil Air Regulations, the following shall be applicable:

43T.11 *Transport category airplane weight limitations.* The performance data in the Airplane Flight Manual shall be applied in determining compliance with the following provisions:

*

FIGURE 13-4. TAKEOFF RUN

Critical Engine Fails at V_{Cr}

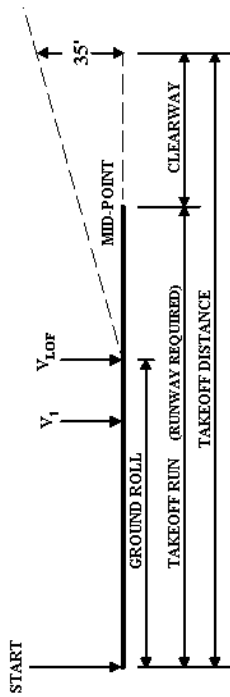

(ii) One hundred fifteen (115) percent of the distance from the start of the takeoff roll to the mid-point between liftoff and the point at which the airplane attains a height of 35 ft. above the takeoff surface, with all engines operating, as shown in Figure 13-5. In establishing the all-engines-operating takeoff run, § 25.113(c)(2) requires the distance to be "...determined by a procedure consistent with § 25.111" (Takeoff Path). The interpretation of that statement is that the all-engines-operating takeoff run should:

- (A) Be based on the airplane reaching a speed of V_2 before it is 35 feet above the takeoff surface; and
- (B) Be consistent with the achievement of a smooth transition to the steady initial climb speed at a height of 400 feet above the takeoff surface.

FIGURE 13-5. TAKEOFF RUN (All-Engines-Operating)

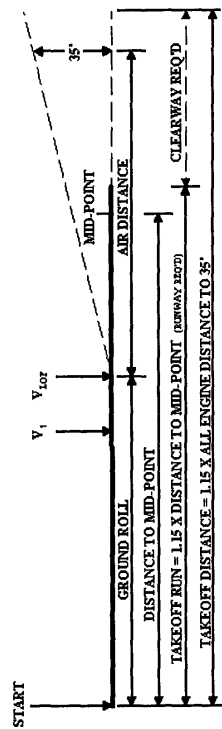

- (2) There may be situations in which the one-engine-inoperative condition (paragraph 1.3c(i)(i)) would dictate one of the distance criteria, takeoff run (required runway) or takeoff distance (required runway plus clearway), while the all-engines-operating condition (paragraph 1.3c(i)(ii)) would dictate the other. Therefore, both conditions should always be considered.
- (3) Clearway is defined in 14 CFR part 1 as a plane extending from the end of the runway with an upward slope not exceeding 1.25 percent, above which no object nor any terrain protrudes. For the purpose of establishing takeoff distances and the length of takeoff runs, the clearway is considered to be part of the takeoff surface extending with the same slope as the runway, and the 35 ft. height should be measured from that surface.

FIGURE 13-6. CLEARWAY PROFILES

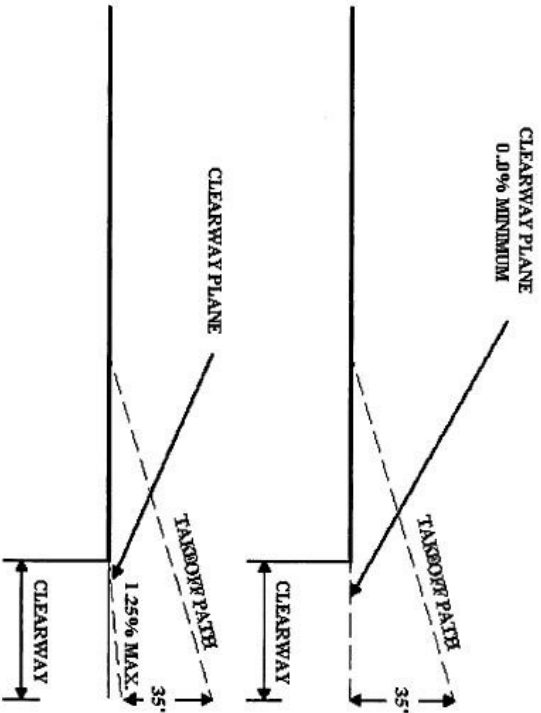

(4) The profile shows no fixed obstacle projecting above the clearway plane. However, the airport authorities must have control of the movable obstacles in this area to ensure that no flight will be initiated using a clearway unless it is determined with certainty that no movable obstacles will exist within the clearway when the airplane flies over.

14. TAKEOFF FLIGHT PATH - § 25.115.

* a. Takeoff Flight Path - § 25.115(a).

(1) *Explanation.* The takeoff flight path begins at the end of the takeoff distance and at a height of 35 ft. above the takeoff surface, and ends when the airplane's actual height is the higher of 1,500 ft. above the takeoff surface or at an altitude at which the configuration and speed have been achieved where the requirements of § 25.121(c) can be met. (See paragraph 12 of this AC (§ 25.111) for additional discussion.) Section 25.115(a) states that the takeoff shall be considered to begin at a height of 35 feet, recognizing that in the case of a wet runway the airplane will only be at a height of 15 feet. For takeoffs from wet runways, the actual airplane height will be 20 feet lower than the takeoff flight path determined under § 25.115. Therefore, the airplane will be 20 feet closer vertically to obstacles after taking off from a wet runway compared to taking off from a dry runway.

(2) Procedures.

defined in Item 5 of this regulation, the takeoff distance shall not include a clearway distance greater than one-half of the take-off run.

(d) No airplane shall be operated outside the operational limits specified in the Airplane Flight Manual. (See secs. 4T.123(a)(4) and 42.743(a).)

40T.82 *Take-off obstacle clearance limitations.* No airplane shall be taken off at a weight in excess of that shown in the Airplane Flight Manual to correspond with a net takeoff flight path which clears all obstacles either by at least a height of 35 feet vertically or by at least 200 feet horizontally within the airport boundaries and by at least 300 feet horizontally after passing beyond the boundaries. In determining the allowable deviation of the flight path in order to avoid obstacles by at least the distances prescribed, it shall be assumed that the airplane is not banked before reaching a height of 50 feet as shown by the take-off path data in the Airplane Flight Manual, and that a maximum bank thereafter does not exceed 15 degrees. The take-off path considered shall be for the elevation of the airport, the effective runway gradient, and for the ambient temperature and wind component existing at the time of takeoff. (See secs. 4T.123(b) and 4T.743(b).)

40T.83 *En route limitations.*

(a) *One engine inoperative.* No airplane shall be taken off at a weight in excess of that which, according to the one-engine-inoperative en route net flight path data shown in the Airplane Flight Manual, will permit compliance with either subparagraph (1) or subparagraph (2) of this paragraph at all points along the route. The net flight path used shall be for the ambient temperatures anticipated along the route. (See secs. 4T.123(b) and 4T.743(b).)

(1) The slope of the net flight path shall be positive at an altitude of at least 1,000 feet above all terrain and obstructions along the route within 5 miles on either side of the intended track.

(2) The net flight path shall be such as to permit the airplane to continue flight from the cruising altitude to an alternate airport where a landing can be made in accordance with the provisions of section 40T.84(b), the net flight path clearing vertically by at least 2,000 feet all terrain and obstructions along the route within 5 miles on either side of the intended track. The provisions of subdivisions (i) through (vii) of this subparagraph shall apply.

(i) The engine shall be assumed to fail at the most critical point along the route.

(ii) The airplane shall be assumed to pass over the critical obstruction following engine failure at a point no closer to the critical obstruction than the nearest approved radio navigational fix, except that the Administrator may authorize a procedure established on a different basis where adequate operational safeguards are found to exist.

(iii) The net flight path shall have a positive slope at 1,500 feet above the airport used as the alternate.

(iv) An approved method shall be used to account for winds which would otherwise adversely affect the flight path.

(v) Fuel jettisoning shall be permitted if the Administrator finds that the operator has an adequate training program, proper instructions are given to the flight crew, and all other precautions are taken to insure a safe procedure.

(vi) The alternate airport shall be specified in the dispatch release and shall meet the prescribed weather minima.

(vii) The consumption of fuel and oil after the engine becomes inoperative shall be that which is accounted for in the net flight path data shown in the Airplane Flight Manual.

(b) *Two engines inoperative.* No airplane shall be flown along an intended route except in compliance with either subparagraph (1) or subparagraph (2) of this paragraph.

AIRPLANE FLIGHT MANUAL

4T.743 *Performance limitations, information, and other data.*

(a) *Limitations.* The airplane's performance limitations shall be given in accordance with section 4T.123(a).

(b) *Information.* The performance information prescribed in section 4T.123(b) for the application of the operating rules of this regulation shall be given together with descriptions of the conditions, air speeds, etc., under which the data were determined.

(c) *Procedures.* Procedures established in accordance with section 4T.111(c) shall be given to the extent such procedures are related to the limitations and information set forth in accordance with paragraphs (a) and (b) of this section. Such procedures, in the form of guidance material, shall be included with the relevant limitations or information, as applicable.

(d) *Miscellaneous.* An explanation shall be given of significant or unusual flight or ground handling characteristics of the airplane.

3. In lieu of sections 40.70 through 40.78, 41.27 through 41.36(d), and 42.70 through 42.83, of Parts 40, 41, and 42 of the Civil Air Regulations, respectively, the following shall be applicable:

OPERATING RULES

40T.80 *Transport category airplane operating limitations.*

(a) In operating any passenger-carrying transport category airplane certificated in accordance with the performance requirements of this regulation, the provisions of sections 40T.80 through 40T.84 shall be complied with, unless deviations therefrom are specifically authorized by the Administrator on the ground that the special circumstances of a particular case make a literal observance of the requirements unnecessary for safety.

(b) The performance data in the Airplane Flight Manual shall be applied in determining compliance with the provisions of sections 40T.81 through 40T.84. Where conditions differ from those for which specific tests were made, compliance shall be determined by approved interpolation or computation of the effects of changes in the specific variables if such interpolations or computations give results substantially equaling in accuracy the results of a direct test.

40T.81 *Airplane's certificate limitations.*

(a) No airplane shall be taken off at a weight which exceeds the take-off weight specified in the Airplane Flight Manual for the elevation of the airport and for the ambient temperature existing at the time of the take-off. (See secs. 4T.123(a)(1) and 4T.743(a).)

(b) No airplane shall be taken off at a weight such that, allowing for normal consumption of fuel and oil in flight to the airport of destination and to the alternate airports, the weight on arrival will exceed the landing weight specified in the Airplane Flight Manual for the elevation of each of the airports involved and for the ambient temperatures anticipated at the time of landing. (See secs. 4T.123(a)(2) and 4T.743(a).)

(c) No airplane shall be taken off at a weight which exceeds the weight shown in the Airplane Flight Manual to correspond with the minimum distances required for takeoff. These distances shall correspond with the elevation of the airport, the runway to be used, the effective runway gradient, and the ambient temperature and wind component existing at the time of take-off. (See secs. 4T.123(a)(3) and 4T.743(a).) If the takeoff distance includes a clearway as

FIGURE 14-1. TAKEOFF SEGMENTS & NOMENCLATURE

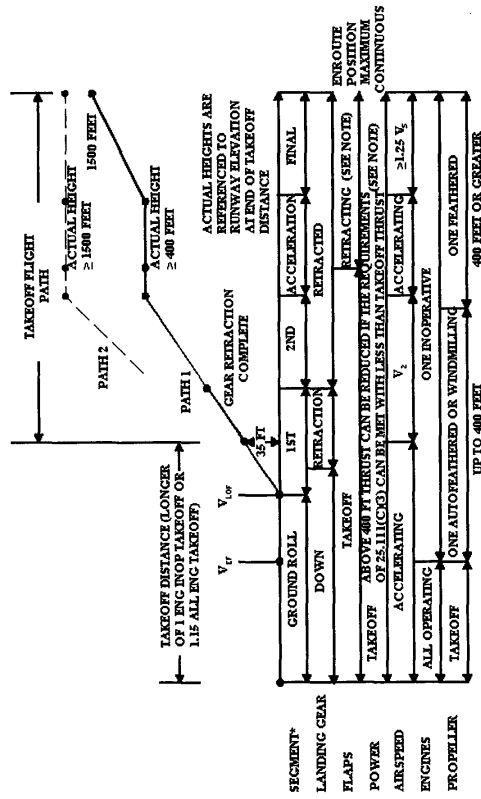

Note: The final takeoff segment will usually begin with the airplane in the en route configuration and with maximum continuous thrust, but it is not required that these conditions exist until the end of the takeoff path when compliance with § 25.121(c) is shown. The time limit on takeoff thrust cannot be exceeded.

* Segments as defined by § 25.121.

b. Net Takeoff Flight Path - §§ 25.115(b) and (c)

(1) Explanation:

(i) The net takeoff flight path is the actual flight path diminished by a gradient of 0.8 percent for two-engine airplanes, 0.9 percent for three-engine airplanes, and 1.0 percent for four-engine airplanes.

(ii) For the level flight acceleration segment, these prescribed gradient reductions may be applied as an equivalent reduction in acceleration in lieu of reduction in net flight path. (See paragraph 12 (ref. § 25.111) of this AC for additional discussion.)

(iii) SR-422B, and § 121.189(d), require that no airplane may take off at a weight in excess of that shown in the AFM to correspond with a net takeoff flight path that clears all obstacles either by at least a height of 35 ft. vertically, or by at least 200 ft. horizontally within the airport boundaries, and by at least 300 ft. horizontally after passing beyond the boundaries.

(iv) With turns in the net takeoff flight path, obstacle clearance determination requires consideration of both radius of turn and climb gradient decrement. Radius of turn, for use in obstacle lateral separation, is not airplane dependent and is readily calculated from speed and bank angle. Climb gradient decrements, however, are airplane dependent. Climb gradient decrements for bank angles up to at least 15 degrees should be contained in the AFM.

(2) Procedures.

FIGURE 14-2. NET TAKEOFF FLIGHT PATH

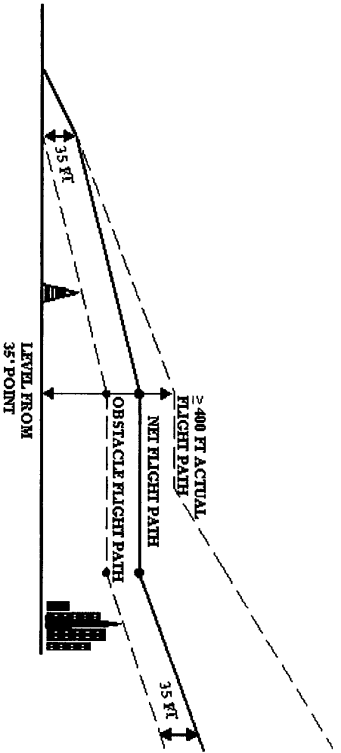

15. CLIMB: GENERAL - § 25.117.

a. Explanation. This section states the climb requirements of §§ 25.119 and 25.121 must be complied with at each weight, altitude, and ambient temperature within the operational limits established for the airplane and with the most unfavorable center of gravity for each configuration. When approval of an airplane for operation in known icing conditions is requested, compliance with the approach climb requirements of § 25.121(d), and landing climb requirements of § 25.119, should be demonstrated with residual ice accretions on unprotected areas of the airframe. For further guidance on this subject see paragraph 231, "Performance Requirements for Flight in Icing Conditions," in Chapter 8 of this AC.

b. Procedures. None.

and runway gradients, as these may be applicable, within the operational limits of the airplane (see subparagraph (a)(4) of this section). In addition, the performance information specified in subparagraphs (1) through (3) of this paragraph shall be determined by extrapolation and scheduled for the ranges of weights between the maximum landing and maximum take-off weights established in accordance with subparagraphs (a) (1) and (a) (2) of this section. (See also sec. 4T.743.)

- (1) Climb in the landing configuration (see sec. 4T.119);
- (2) Climb in the approach configuration (see sec. 4T.120(d));
- (3) Landing distance (see sec. 4T.122).

(c) The landing distance shall be based on a smooth, dry, hard-surfaced runway, and shall be determined in such a manner that reproduction does not require exceptional skill or alertness on the part of the pilot. In the case of seaplanes or float planes, the landing surface shall be smooth water, while for skiplanes it shall be smooth dry snow. During landing, the airplane shall not exhibit excessive vertical acceleration, a tendency to bounce, nose over, ground loop, porpoise, or water loop.

(d) The landing distance shall be corrected for not more than 50 percent of nominal wind components along the landing path opposite to the direction of landing and not less than 150 percent of nominal wind components along the landing path in the direction of landing.

(e) During landing, the operating pressures on the wheel braking system shall not be in excess of those approved by the manufacturer of the brakes, and the wheel brakes shall not be used in such a manner as to produce excessive wear of brakes and tires.

(f) In addition to, or in lieu of, wheel brakes, the use of other braking means shall be acceptable in determining the landing distance, provided such braking means shall have been proven to be safe and reliable, that the manner of their employment is such that consistent results can be expected in service, and that exceptional skill is not required to control the airplane.

(g) If the characteristics of a device (e.g., the propellers) dependent upon the operation of any of the engines noticeably increase the landing distance when the landing is made with the engine inoperative, the landing distance shall be determined with the critical engine inoperative unless the Administrator finds that the use of compensating means will result in a landing distance not greater than that attained with all engines operating.

4T.123 Limitations and information.

(a) *Limitations.* The performance limitations on the operation of the airplane shall be established in accordance with subparagraphs (1) through (4) of this paragraph. (See also Sec. 4T.743.)

(1) *Take-off weights.* The maximum take-off weights shall be established at which compliance is shown with the generally applicable provisions of this regulation and with the take-off climb provisions prescribed in section 4T.120 (a), (b), and (c) for altitudes and ambient temperatures within the operational limits of the airplane (see subparagraph (4) of this paragraph).

(2) *Landing weights.* The maximum landing weights shall be established at which compliance is shown with the generally applicable provisions of this regulation and with the landing and take-off climb provisions prescribed in sections 4T.119 and 4T.120 for altitudes and ambient temperatures within the operational limits of the airplane (see subparagraph (4) of this paragraph).

(3) *Accelerate-stop distance, take-off distance, and take-off run.* The minimum distances required for take-off shall be established at which compliance is shown with the generally applicable provisions of this regulation and with sections 4T.115 and 4T.117(a), and with 4T.117(b) if the take-off distance is intended to include a clearway, for weights, altitudes, temperatures, wind components, and runway gradients, within the operational limits of the airplane (see subparagraph (4) of this paragraph).

(4) *Operational limits.* The operational limits of the airplane shall be established by the applicant for all variable factors required in showing compliance with this regulation (weight, altitude, temperature, etc.). (See secs. 4T.113 (a)(1) and (b), 4T.118, 4T.121, and 4T.122.)

(b) *Information.* The performance information on the operation of the airplane shall be scheduled in compliance with the generally applicable provisions of this regulation and with sections 4T.117a(b), 4T.121, and 4T.122 for weights, altitudes, temperatures, wind components,

16. LANDING CLIMB: ALL-ENGINES-OPERATING - § 25.119.

a. *Explanation.* Section 25.119(a) states that the engines are to be set at the power or thrust that is available 8 seconds after initiating movement of the power or thrust controls from the minimum flight idle position to the go-around power or thrust setting. The procedures given below are for the determination of this maximum thrust for showing compliance with the climb requirements of § 25.119.

b. Procedures.

(1) The engines should be trimmed to the low side of the idle trim band, if applicable, as defined in the airplane maintenance manual. The effect of any variation in the idle fuel flow schedule for engines with electronic fuel controllers is typically negligible (but any such claim should be adequately substantiated).

(2) At the most adverse test altitude, not to exceed the maximum field elevation for which certification is sought plus 1,500 ft., and with the most adverse bleed configuration expected in normal operations, stabilize the airplane in level flight with symmetrical power on all engines, landing gear down, flaps in the landing position, at a speed of 1.3 V_{SO} . Retard the throttle(s) of the test engine(s) to flight idle and determine the time needed to reach a stabilized r.p.m., as defined below, for the test engine(s) while maintaining level flight or the minimum rate of descent obtainable with the thrust of the remaining engine(s) not greater than maximum continuous thrust (MCT). Engine flight idle r.p.m. is considered to be stabilized when the initial rapid deceleration of all rotors is completed. This has usually been 8-20 seconds. This can be determined in the cockpit as the point where rapid movement of the tachometer ceases. For some airplanes it may be desirable to determine the deceleration time from plots of r.p.m. versus time.

(3) For the critical air bleed configuration, stabilize the airplane in level flight with symmetric power on all engines, landing gear down, flaps in the landing position, at a speed of 1.3 V_{SO} , simulating the estimated minimum climb-limited landing weights (goal is low airspeed for low idle r.p.m.) at an altitude sufficiently above the selected test altitude so that time to descend to the test altitude with the throttles closed equals the appropriate engine r.p.m. stabilization time determined in paragraph (2) above. Retard the throttles to the flight idle position and descend at 1.3 V_{SO} to approximately the test altitude. When the appropriate time has elapsed, rapidly advance the power or thrust controls to the go-around power or thrust setting. The power or thrust controls may first be advanced to the forward stop and then retarded to the go-around power or thrust setting. At the applicant's option, additional less critical bleed configurations may be tested.

(4) The thrust that is available 8 seconds after the initiation of movement of the power or thrust controls from the minimum flight idle position, in accordance with paragraph (3) above, will be the maximum permitted for showing compliance with the landing climb requirements of § 25.119(a), and Section 4T.119(a) of SR-422B (see Appendix 1) for each of the bleed combinations tested in accordance with paragraph (3) above. If AFM performance is presented such that there is no accountability for various bleed conditions, the thrust obtained with the most critical air bleed shall be used for landing climb performance for all operations. The effects of anti-ice bleed must be accounted for.

17. CLIMB: ONE-ENGINE-INOPERATIVE - § 25.121.

a. Explanation. None.

b. Procedures.

(1) Two methods for establishing one-engine-inoperative climb performance follow:

(i) Reciprocal heading climbs are conducted at several thrust-to-weight conditions from which the performance for the AFM is extracted. These climbs are flown with the wings nominally level. Reciprocal climbs may not be necessary if inertial corrections (or another equivalent means) are applied to account for wind gradients.

(ii) Drag polars and one-engine-inoperative yaw drag data are obtained for expansion into AFM climb performance. These data are obtained with the wings nominally level. Reciprocal heading check climbs are conducted to verify the predicted climb performance. These check climbs may be flown with the wings maintained

in a near level attitude. Reciprocal climbs may not be necessary if inertial corrections (or another equivalent means) are applied to account for wind gradients.

(2) If full rudder with wings level cannot maintain constant heading, small bank angles into the operating engine(s), with full rudder, should be used to maintain constant heading. Unless the landing lights automatically retract with engine failure, testing should be conducted with the lights extended for § 25.121(a) Takeoff, landing gear extended, § 25.121(b) Takeoff, landing gear retracted, and § 25.121(d) Approach.

(3) The climb performance tests with landing gear extended, in accordance with § 25.121(a), may be conducted with the landing gear and gear doors in the position they finally achieve after "gear down" selection. The critical configuration for the landing gear extended climb is considered to be that which presents the largest frontal area to the local airflow. This would normally be with no weight on the landing gear (full strut extension and trucks tilted) and all gear doors open. However, since the takeoff path will be determined by measurement of continuous takeoffs, or checked by continuous takeoffs if constructed by the segmental method (Ref. § 25.111(d)), any non-conservatism arising from the gear doors "closed" climb data will be evident. Also, some measure of conservatism is added to the landing gear extended climb performance by the requirement of § 25.111(d)(3) for the takeoff path data to be based on the airplane's performance without ground effect.

(4) Elements, such as variable intake doors, are provided to control powerplant cooling air supply during takeoff, climb, and en route flight, they should be set in a position that will maintain the temperature of major powerplant components, engine fluids, etc., within the established limits. The effect of these procedures should be included in the climb performance of the airplane. These provisions apply for all ambient temperatures up to the highest operational temperature limit for which approval is desired. (Reference: § 25.1043)

(5) The latter parts of §§ 25.121(a)(1) and (b)(1), which state "...unless there is a more critical power operating condition existing later along the flight path..." are intended to cover those cases similar to where a wet engine depletes its water and reverts to dry engine operation. This is not intended to cover normal altitude thrust lapses above the point where the landing gear is fully retracted. (Reference: Preamble to SR-422A)

(6) Section 25.121(d) requires that the stalling speed for the approach configuration, landing gear retracted, not exceed 110 percent of the stalling speed for the related landing configuration, landing gear extended. This stall speed ratio requirement is to ensure that an adequate margin above the stall speed in the selected approach configuration is maintained during flap retraction. To achieve this stall speed spread requirement, it is permissible to arbitrarily increase the landing flap stalling speed, V_{S0} , to show compliance. The AFM must, however, base the landing speed on the increased stalling speed, and the landing distance demonstrations and the AFM landing field length requirements must also be predicated on the increased speed. The stall warning requirements of § 25.207 must be established for the adjusted stalling speed. However, the § 25.203 stall characteristics requirements must still be met at the normal stall speed. (An alternative to raising the landing flap stall speed, V_{S0} , is to simply increase the landing speed stall ratio to a value greater than 1.3.)

18. ENROUTE FLIGHT PATHS. - § 25.123.

a. **Explanation.** This guidance is intended for showing compliance with the requirements of § 25.123 and application to the operating requirements of §§ 121.191 and 121.193, which specify the clearances over terrain and obstructions required of the net en route flight paths subsequent to the failure of one or two engines.

b. Procedures.

(1) Sufficient en route climb performance data should be presented in the AFM to permit the determination of the net climb gradient and the net flight path in accordance with §§ 25.123(b) and (c) for all gross weights, altitudes, and ambient temperatures within the operating limits of the airplane. This en route climb performance data should be presented for altitudes up to the all-engines-operating ceiling to permit the calculation of drift-down data in the event of an en route engine failure.

(2) **Fuel Consumption Accountability.** The effect of the variation of the airplane's weight along the flight path due to the progressive consumption of fuel may be taken into account using fuel flow rates obtained from airplane manufacturers' test data. If measured fuel flow data is unavailable, a conservative fuel flow rate not greater than 80 percent of the engine specification flow rate at maximum continuous thrust (MCT) may be used.

(2) The weight equal to the airplane's weight existing in accordance with section 4T.116 at the end of the take-off path;

(3) The speed equal to not less than 1.25 V_S

(d) *Approach.* In the approach configuration such that the corresponding V_S for this configuration does not exceed 110 percent of the V_S corresponding with the related landing configuration, the steady gradient of climb shall not be less than 2.2 percent for two-engine airplanes and not less than 2.7 percent for four-engine airplanes with:

(1) The critical engine inoperative, the remaining engine(s) operating at the available take-off power and/or thrust;

(2) The weight equal to the maximum landing weight;

(3) A climb speed established by the applicant in connection with normal landing procedures, except that it shall not exceed 1.5 V_S (see sec. 4T.111(c)).

4T.121 *En route flight paths.* With the airplane in the en route configuration, the flight paths prescribed in paragraphs (a) and (b) of this section shall be determined at all weights, altitudes, and ambient temperatures within the limits established by the applicant for the airplane, in a manner that they represent the airplane's actual climb performance diminished by a gradient of climb equal to 1.1 percent for two-engine airplanes and 1.6 percent for four-engine airplanes. It shall be acceptable to include in these data the variation of the airplane's weight along the flight path to take into account the progressive consumption of fuel and oil by the operating engine(s).

(b) *Two engines inoperative.* For airplanes with four engines, the two-engine-inoperative net flight path data shall be determined in such a manner that they represent the airplane's actual climb performance diminished by a gradient of climb equal to 0.5 percent. It shall be acceptable to include in these data the variation of the airplane's weight along the flight path to take into account the progressive consumption of fuel and oil by the operating engines.

(c) *Conditions.* In determining the flight paths prescribed in paragraphs (a) and (b) of this section, the conditions of subparagraphs (1) through (4) of this paragraph shall apply.

(1) The airplane's center of gravity shall be in the most unfavorable position.

(2) The critical engine(s) shall be inoperative, the remaining engine(s) operating at the available maximum continuous power and/or thrust.

(3) Means for controlling the engine cooling air supply shall be in the position which provides adequate cooling in the hot-day condition.

(4) The speed shall be selected by the applicant.

4T.122 *Landing distance.* The landing distance shall be the horizontal distance required to land and to come to a complete stop (to a speed of approximately 3 knots in the case of seaplanes or float planes) from a point at a height of 50 feet above the landing surface. Landing distances shall be determined for standard temperatures at all weights, altitudes, and winds within the operational limits established by the applicant for the airplane. The conditions of paragraphs (a) through (g) of this section shall apply.

(a) The airplane shall be in the landing configuration. During the landing, changes in the airplane's configuration, in power and/or thrust, and in speed shall be in accordance with procedures established by the applicant for the operation of the airplane in service. The procedures shall comply with the provisions of section 4T.111(c).

(b) The landing shall be preceded by a steady gliding approach down to the 50-foot height with a calibrated air speed of not less than 1.3 V_S

- (a) The take-off flight path shall be considered to begin at a height of 35 feet above the take-off surface at the end of the take-off distance as determined in accordance with section 4T.117(a).
- (b) The net take-off flight path data shall be determined in such a manner that they represent the airplane's actual take-off flight paths, determined in accordance with paragraph (a) of this section, diminished by a gradient of climb equal to 1.0 percent.

4T.118 *Climb; general.* Compliance shall be shown with the climb requirements of sections 4T.119 and 4T.120 at all weights, altitudes, and ambient temperatures, within the operational limits established by the applicant for the airplane. The airplane's center of gravity shall be in the most unfavorable position corresponding with the applicable configuration.

4T.119 *All engine-operating landing climb.* In the landing configuration the steady gradient of climb shall not be less than 3.2 percent, with:

- (a) All engines operating at the power and/or thrust which is available 8 seconds after initiation of movement of the power and/or thrust controls from the minimum flight idle to the take-off position;
- (b) A climb speed not in excess of 1.3 V_S

4T.120 *One engine-inoperative climb.*

(a) *Take-off; landing gear extended.* In the take-off configuration existing at the point of the flight path where the airplane first becomes airborne, in accordance with section 4T.116 but without ground effect, the steady gradient of climb shall be positive for two-engine airplanes and shall not be less than 0.5 percent for four-engine airplanes, with:

- (1) The critical engine inoperative, the remaining engine(s) operating at the available take-off power and/or thrust existing in accordance with section 4T.116 at the time retraction of the airplane's landing gear is initiated, unless subsequently a more critical power operating condition exists along the flight path prior to the point where the landing gear is fully retracted;
- (2) The weight equal to the airplane's weight existing in accordance with section 4T.116 at the time retraction of the airplane's landing gear is initiated;
- (3) The speed equal to the speed V_2 .

(b) *Take-off; landing gear retracted.* In the take-off configuration existing at the point of the flight path where the airplane's landing gear is fully retracted, in accordance with section 4T.116 but without ground effect, the steady gradient of climb shall not be less than 2.5 percent for two-engine airplanes and not less than 3.0 percent for four-engine airplanes, with:

- (1) The critical engine inoperative, the remaining engine(s) operating at the available take-off power and/or thrust existing in accordance with section 4T.116 at the time the landing gear is fully retracted, unless subsequently a more critical power operating condition exists along the flight path prior to the point where a height of 400 feet above the take-off surface is reached;
- (2) The weight equal to the airplane's weight existing in accordance with section 4T.116 at the time the airplane's landing gear is fully retracted.
- (3) The speed equal to the speed V_2 .

(c) *Final take-off.* In the en route configuration, the steady gradient of climb shall not be less than 1.2 percent for two-engine airplanes and not less than 1.7 percent for four-engine airplanes, at the end of the take-off path as determined by section 4T.116, with:

- (1) The critical engine inoperative, the remaining engine(s) operating at the available maximum continuous power and/or thrust;

- (3) The procedures and flight conditions upon which the en route flight path data are based should be provided to the flightcrew. Credit for fuel dumping, if available and included in the flightcrew procedures, may be used to achieve the performance capability presented in the AFM. A conservative analysis should be used in taking into account the ambient conditions of temperature and wind existing along the flight path. All performance should be based on the net flight path and with MCT on the operating engine(s).

19. LANDING - § 25.125.

a. Explanation.

(1) The landing distance is the horizontal distance from the point at which the main gear of the airplane is 50 ft. above the landing surface (treated as a horizontal plane through the touchdown point) to the point at which the airplane is brought to a stop. (For water landings, a speed of approximately 3 knots is considered "stopped.") In this AC, the distance is treated in two parts: the airborne distance from 50 ft. to touchdown, and the ground distance from touchdown to stop. The latter may be further subdivided into a transition phase and a full braking phase if the applicant prefers this method of analysis.

(2) The term V_{REF} used in this AC means the landing threshold speed (i.e., speed at 50 ft. height) scheduled in the AFM for normal operations. The minimum value of V_{REF} is specified in § 25.125(a)(2) as 1.3 V_S , which provides an adequate margin above the stall speed to allow for likely speed variations during an approach in low turbulence. If the landing demonstrations are unable to show the acceptability of the minimum approach speed, and the tests are predicated on the use of a V_{REF} greater than the minimum 1.3 V_S , the landing distance data presented in the AFM must be based upon the higher approach speed.

(3) The engines should be set to the high side of the flight idle trim band, if applicable, for the landing flight tests. The effect of any variation in the idle fuel flow schedule for engines with electronic fuel controllers is typically negligible (but any such claim should be adequately substantiated).

b. Procedures for Determination of the Airborne Distance. Three acceptable means of compliance are described in paragraphs (1), (2), and (3) below. These differ from the "traditional" method in which steep approaches and high touchdown sink rates were permitted. Such a demonstration of maximum performance is no longer considered acceptable. However, the distances obtained using that method have resulted in a satisfactory operational safety record. The methods given here allow credit for the amount of testing an applicant is prepared to conduct, such that if the method described in paragraph 19b(3) (the most complex) is chosen, distances typical of those from the "traditional" method should be obtained, but without incurring the associated risks during testing.

NOTE. If it is determined that the constraints on approach angle and touchdown rate-of-sink described in paragraphs (2) and (3), below, are not appropriate due to novel or unusual features of future transport category airplane design, new criteria may be established. Such a change would be acceptable only if it is determined that an equivalent level of safety to existing performance standards and operational procedures is maintained.

- (1) Experience shows an upper bound to the Part 25 zero-wind airborne distances achieved in past certifications and, similarly, a minimum speed loss. These are approximated by the following:

$$\text{Air Distance (feet)} = 1.55 (V_{REF} - 80)^{1.35} + 800 \quad \text{where } V_{REF} \text{ is in knots TAS}$$

$$\text{Touchdown Speed} = V_{REF} - 3 \text{ knots}$$

An applicant may choose to use these relationships to establish landing distance in lieu of measuring airborne distance and speed loss. If an applicant chooses to use these relationships, it must be shown by test or analysis that they do not result in air distances or touchdown speeds that are nonconservative.

- (2) If an applicant chooses to measure airborne distance or time, at least six tests covering the landing weight range are required for each airplane configuration for which certification is desired. These tests should meet the following criteria:

(i) A stabilized approach, targeting a glide slope of -3 degrees and an indicated airspeed of V_{REF} , should be maintained for a sufficient time prior to reaching a height of 50 feet above the landing surface to simulate a continuous approach at this speed. During this time, there should be no appreciable change in the power setting, pitch attitude, or rate of descent. The average glide slope of all landings used to show compliance should not be steeper than -3 degrees.

(ii) Below 50 feet, there should be no nose depression by use of the longitudinal control and no change in configuration, except for reduction in power.

(iii) The target rate of descent at touchdown should not exceed 6 feet per second. Target values cannot be achieved precisely; however, the average touchdown rate of descent should not exceed 6 feet per second.

(3) If the applicant conducts enough tests to allow a parametric analysis (or equivalent method) that establishes, with sufficient confidence, the relationship between airborne distance (or time) as a function of the rates of descent at 50 feet and touchdown, the 14 CFR part 25 airborne distances may be based on an approach angle of -3.5 degrees, and a touchdown sink rate of 8 feet per second (see paragraph 19g for a sample of this analysis method).

(i) The air distance or air time established by this method may not be less than 90 percent of the lowest demonstrated value obtained using the target values for approach angle and touchdown sink rate specified in paragraph (ii), below. Test data with approach angles steeper than -3.5 degrees, or touchdown sink rates greater than 8 feet per second, may not be used to satisfy this requirement.

(ii) In order to determine the parametric relationships, it is recommended that test targets should span approach angles from -2.5 degrees to -3.5 degrees, and sink rates at touchdown from 2-6 ft. per second. Target speed for all tests should be V_{REF} .

(iii) Below 50 feet, there should be no nose depression by use of the longitudinal control and no change in configuration that requires action by the pilot, except for reduction in power.

(iv) If an acceptable method of analysis is developed by an applicant to statistically establish a satisfactory confidence level for the resulting parametric relationships, then 12 tests, in each aerodynamic configuration for which certification is desired, will be sufficient. More tests will be necessary if the distribution of the data does not give sufficient confidence in the parametric correlation. Past experience has shown that a total of 40 landings would establish a satisfactory confidence level without further analysis. Anomalies may be included in the analysis but should not comprise more than half of the data points. If it is apparent that configuration is not a significant variable, all data may be included in a single parametric analysis.

(v) If an applicant proposes any other method as being equivalent to a parametric analysis, that method should be based on a developed mathematical model that employs performance-related variables such as thrust, attitude, angle of attack, and load factor to adequately reproduce the flight test trajectory and airspeed variation from the 50 foot point to touchdown. Such a mathematical model should be validated by not less than 12 tests in each aerodynamic configuration for which certification is desired, and be justified by a comparison of tested and calculated landing airborne distances.

(vi) For the same aerodynamic configuration as previously certificated—if new tests are necessary to substantiate performance to a weight higher than that permitted by the extrapolation limits of § 25.21(d), two landings per configuration will be required for each 5 percent increase in landing weight, with a maximum total requirement of six landings. These may be merged with previous certification tests for parametric analysis, whether the previous certification was conducted by this method or not. If a new aerodynamic configuration is proposed, the 12 tests per configuration described in paragraph (v), above, must be conducted.

(vii) In calculating the AFM landing distances, the speed loss from 50 feet to touchdown, as a percentage of V_{REF} , may be determined using the conditions described in paragraph 19b(3).

(4) Whichever method is chosen to establish airborne distances, satisfactory flight characteristics must be demonstrated in the flare maneuver when a final approach speed of $V_{REF}-5$ knots is maintained down to 50 feet.

(e) The airplane shall attain the speed V_2 prior to reaching a height of 35 feet above the take-off surface and shall continue at a speed as close as practical to, but not less than, V_2 until a height of 400 feet above the take-off surface is reached.

(f) Except for gear retraction and propeller feathering, the airplane configuration shall not be changed before reaching a height of 400 feet above the take-off surface.

(g) At all points along the take-off path starting at the point where the airplane first reaches a height of 400 feet above the take-off surface, the available gradient of climb shall not be less than 1.2 percent for two-engine airplanes and 1.7 percent for four-engine airplanes.

(h) The take-off path shall be determined either by a continuous demonstrated take-off, or alternatively, by synthesizing from segments the complete take-off path.

(i) If the take-off path is determined by the segmental method, the provisions of subparagraphs (1) through (4) of this paragraph shall be specifically applicable.

(1) The segments of a segmental take-off path shall be clearly defined and shall be related to the distinct changes in the configuration of the airplane, in power and/or thrust, and in speed.

(2) The weight of the airplane, the configuration, and the power and/or thrust shall be constant throughout each segment and shall correspond with the most critical condition prevailing in the particular segment.

(3) The segmental flight path shall be based on the airplane's performance without ground effect.

(4) Segmental take-off path data shall be checked by continuous demonstrated takeoffs to insure that the segmental path is conservative relative to the continuous path.

4T.117 Take-off distances and take-off run.

(a) Take-off distance. The take-off distance shall be the greater of the distances established in accordance with subparagraphs (1) and (2) of this paragraph.

(1) The horizontal distance along the take-off path from the start of the take-off to the point where the airplane attains a height of 35 feet above the take-off surface, as determined in accordance with section 4T.116.

(2) A distance equal to 115 percent of the horizontal distance along the take-off path, with all engines operating, from the start of the take-off to the point where the airplane attains a height of 35 feet above the take-off surface, as determined by a procedure consistent with that established in accordance with section 4T.116.

(b) Take-off run. If the take-off distance is intended to include a clearway (see item 5 of this regulation), the take-off run shall be determined and shall be the greater of the distances established in accordance with subparagraphs (1) and (2) of this paragraph.

(1) The horizontal distance along the take-off path from the start of the take-off to a point equidistant between the point where the airplane first becomes airborne and the point where it attains a height of 35 feet above the take-off surface, as determined in accordance with section 4T.116.

(2) A distance equal to 115 percent of the horizontal distance along the take-off path, with all engines operating, from the start of the take-off to a point equidistant between the point where the airplane first becomes airborne and the point where it attains a height of 35 feet above the take-off surface, as determined by a procedure consistent with that established in accordance with section 4T.116.

4T.117a Take-off flight path.

(2) 1.15 V_s for propeller-driven airplanes having more than two engines and for airplanes without propellers which have provisions for obtaining a significant reduction in the one-engine-inoperative power-on stalling speed;

(3) 1.10 times the minimum control speed V_{MC} , established in accordance with section 4b.133 of Part 4b of the Civil Air Regulations;

(4) The rotation speed V_R plus the increment in speed attained in compliance with section 4T.116(c).

(c) The minimum rotation speed V_R in terms of calibrated air speed, shall be selected by the applicant, except that it shall not be less than:

(1) The speed V_1 ;

(2) A speed equal to 95 percent of the highest speed obtained in compliance with subparagraph (1) or (2), whichever is applicable, and with subparagraph (3) of paragraph (b) of this section;

(3) A speed which permits the attainment of the Speed V_2 prior to reaching a height of 35 feet above the take-off surface as determined in accordance with section 4T.116(c);

(4) A speed equal to 110 percent of the minimum speed above which the airplane, with all engines operating, can be made to lift off the ground and to continue the take-off without displaying any hazardous characteristics.

4T.115 Accelerate-stop distance.

(a) The accelerate-stop distance shall be the sum of the following:

(1) The distance required to accelerate the airplane from a standing start to the speed V_1 ;

(2) Assuming the critical engine to fail at the speed V_1 , the distance required to bring the airplane to a full stop from the point corresponding with the speed V_1 .

(b) In addition to, or in lieu of, wheel brakes, the use of other braking means shall be acceptable in determining the accelerate-stop distance, provided that such braking means shall have been proven to be safe and reliable, that the manner of their employment is such that consistent results can be expected in service, and that exceptional skill is not required to control the airplane.

(c) The landing gear shall remain extended throughout the accelerate-stop distance.

4T.116 *Take-off path.* The take-off path shall be considered to extend from the standing start to a point in the take-off where a height of 1,500 feet above the take-off surface is reached or to a point in the take-off where the transition from the take-off to the en route configuration is completed and a speed is reached at which compliance with section 4T.120(c) is shown, whichever point is at a higher altitude. The conditions of paragraphs (a) through (i) of this section shall apply in determining the take-off path.

(a) The take-off path shall be based upon procedures prescribed in accordance with section 4T.111(c).

(b) The airplane shall be accelerated on the ground to the speed V_1 at which point the critical engine shall be made inoperative and shall remain inoperative during the remainder of the take-off. Subsequent to attaining speed V_1 , the airplane shall be accelerated to speed V_2 , during which time it shall be permissible to initiate raising the nose gear off the ground at a speed not less than the rotation speed V_R .

(c) Landing gear retraction shall not be initiated until the airplane becomes airborne.

(d) The slope of the airborne portion of the take-off path shall be positive at all points.

(i) Below 50 feet, the application of longitudinal control to initiate flare should occur at the same altitude as for a normal "on-speed" landing; no nose depression should be made and power should not be increased to facilitate the flare.

(ii) All power levers should be in their minimum flight idle position prior to touchdown.

(iii) The normal flare technique should be used such that the touchdown speed should be at least 5 knots less than the touchdown speed used to establish the landing distance and the rate of descent at touchdown should not be greater than 6 feet per second.

(iv) This demonstration must be performed at both maximum landing weight and near minimum landing weight.

(v) These VREF-5 knots landing demonstration must not require the use of high control forces or full control deflections.

c. Procedures for Determination of the Transition and Stopping Distances.

(1) The transition distance extends from the initial touchdown point to the point where all approved deceleration devices are operative. The stopping distance extends from the end of transition to the point where the airplane is stopped. The two phases may be combined if the applicant prefers this method of analysis.

(2) If sufficient data are not available, there should be a minimum of six landings in the primary landing configuration. Experience has shown that if sufficient data are available for the airplane model to account for variation of braking performance with weight, lift, drag, ground speed, torque limit, etc., at least two test runs are necessary for each configuration when correlation for multiple configurations is being shown.

(3) A series of at least six measured landing tests covering the landing weight range should be conducted on the same set of wheels, tires, and brakes in order to substantiate that excessive wear of wheel brakes and tires is not produced in accordance with the provisions of § 25.125(b). The landing tests should be conducted with the normal operating brake pressures for which the applicant desires approval. The main gear tire pressure should be set to not less than the maximum pressure desired for certification corresponding to the specific test weight. Longitudinal control and brake application procedures must be such that they can be consistently applied in a manner that permits the airplane to be de-rotated at a controlled rate to preclude an excessive nose gear touchdown rate and so that the requirements of §§ 25.125(a)(4) and (5) are met. Nose gear touchdown rates in the certification landing tests should not be greater than eight feet per second. Certification practice has not allowed manually applied brakes before all main gear wheels are firmly on the ground.

(4) Airplane operating procedures appropriate for determination of landing distance must be described in the performance section of the AFM.

(5) Propeller pitch position used in determining the normal all-engines-operating landing stopping distance should be established using the criteria of § 25.125(f) for those airplanes that may derive some deceleration benefit from operating engines. Section 25.125(f) states that if the landing distance determined using a "device" that depends on the operation of any engine would be "noticeably increased" when a landing is made with that engine inoperative, the landing distance must be determined with that engine inoperative, unless a "compensating means" will result in one-engine-inoperative landing distances not greater than those with all engines operating. Acceptable interpretations of the terms "device," "noticeably increased," and "compensating means" are described below.

(i) If the propeller produces drag at any speed during the stopping phase of the normal all-engines-operating landing distance, the maximum drag from this "device" for which performance credit may be taken is that which results from a propeller pitch position that renders zero thrust at zero airspeed. If the normal operational ground idle setting produces negative thrust at zero airspeed, the all-engines-operating stopping distances should be determined using a special flight test power lever stop to limit the propeller blade angle.

(ii) Distances should be measured for landings made with the propeller feathered on one engine, and ground idle selected after touchdown on the operating engines. The airplane configuration for this test, including the ground idle power lever position, should be the same as that used for the all-engines-operating landing

distance determination. The nose wheel should be free to caster, as in V_{acc} tests, to simulate wet runway surface conditions. Differential braking may be used to maintain directional control. This testing should be conducted at a minimum of three weights that cover the expected range of operational landing weights. If the resulting distances do not exceed the all-engines-operating landing distances by more than two percent (2%), they are not "noticeably increased" and no further testing is required to take performance credit for all-engines-operating disk drag in Airplane Flight Manual (AFM) landing distances.

(iii) If the distances determined in paragraph (ii), above, are more than two percent greater than the all-engines-operating landing distances, it must be shown that a "compensating means" exists in order to take performance credit for the all-engines-operating disk drag. Reverse propeller thrust on the operating engines is considered a "compensating means" if the resulting landing distances, with one propeller feathered, are demonstrated to be not longer than those determined for all-engines-operating with disk drag. The airplane configuration for this test should be the same as that used for the all-engines-operating landing distance determination. The nose wheel should be free to caster, as in V_{acc} tests, to simulate wet runway surface conditions. Differential braking may be used to maintain directional control. Reverse thrust should not be selected until one second after nose wheel touchdown. This testing should be conducted at a minimum of three weights that cover the expected range of operational landing weights.

d. Instrumentation and Data. Instrumentation should include a means to record the airplane's glide path relative to the ground, and the ground roll against time, in a manner that permits determining the horizontal and vertical distance time-histories. The appropriate data to permit analysis of these time-histories should also be recorded.

e. Landing on Unpaved Runways. Guidance material for evaluation of landing on unpaved runways is contained in Chapter 8 of this AC.

f. Automatic Braking Systems. Guidance material relative to evaluation of auto-brake systems is provided in paragraph 55c(6) of this AC.

g. Airplane Flight Manual Landing Distances.

(1) As a minimum, the AFM must include data for standard temperature and zero runway gradient showing the variation of landing distance with weight (up to maximum takeoff weight), altitude, and wind. If the airplane is intended for operation under Part 121 of the FAR, the distances presented should include the operational field length factors for both dry and wet runways required by § 121.195.

* (2) In accordance with § 25.101(f), AFM landing distances must be determined with all the airplane wheel brake assemblies at the fully worn limit of their allowable wear range. The brakes may be in any wear state during the flight tests used to determine the landing distances, as long as a suitable combination of airplane and dynamometer tests is used to determine the landing distances corresponding to fully worn brakes. Alternatively, the relationship between brake wear and stopping performance established during accelerate-stop testing may be used if it encompasses the brake wear conditions and energies achieved during the airplane flight tests used to establish the landing distances. *

(3) In deriving the scheduled distances, the time delay shown below should be assumed.

(a) The speed V_S shall denote the calibrated stalling speed, or the minimum steady flight speed at which the airplane is controllable, in knots, with:

(1) Zero thrust at the stalling speed, or engines idling and throttles closed if it is shown that the resultant thrust has no appreciable effect on the stalling speed;

(2) If applicable, propeller pitch controls in the position necessary for compliance with subparagraph (1) of this paragraph; the airplane in all other respects (flaps, landing gear, etc.) in the particular configuration corresponding with that in connection with which V_S is being used;

(3) The weight of the airplane equal to the weight in connection with which V_S is being used to determine compliance with a particular requirement;

(4) The center of gravity in the most unfavorable position within the allowable range.

(b) The stall speed defined in this section shall be the minimum speed obtained in flight tests conducted in accordance with the procedure of subparagraphs (1) and (2) of this paragraph.

(1) With the airplane trimmed for straight flight at a speed of 1.4 V_S and from a speed sufficiently above the stalling speed to insure steady conditions, the elevator control shall be applied at a rate such that the airplane speed reduction does not exceed one knot per second.

(2) During the test prescribed in subparagraph (1) of this paragraph, the flight characteristics provisions of section 4b.160 of Part 4b of the Civil Air Regulations shall be complied with.

4T.113 *Take-off; general*

(a) The take-off data in sections 4T.114 through 4T.117 shall be determined under the conditions of subparagraphs (1) and (2) of this paragraph.

(1) At all weights, altitudes, and ambient temperatures within the operational limits established by the applicant for the airplane.

(2) In the configuration for take-off (see sec. 4T.111).

(b) Take-off data shall be based on a smooth, dry, hard-surfaced runway and shall be determined in such a manner that reproduction of the performance does not require exceptional skill or alertness on the part of the pilot. In the case of seaplanes or float planes, the take-off surface shall be smooth water, while for skiplanes it shall be smooth dry snow. In addition, the take-off data shall be corrected in accordance with subparagraphs (1) and (2) of this paragraph for wind and for runway gradients within the operational limits established by the applicant for the airplane.

(1) Not more than 50 percent of nominal wind components along the take-off path opposite to the direction of take-off, and not less than 150 percent of nominal wind components along the take-off path in the direction of take-off.

(2) Effective runway gradients.

4T.114 *Take-off speeds.*

(a) The critical-engine-failure speed V_1 , in terms of calibrated air speed, shall be selected by the applicant, but shall not be less than the minimum speed at which controllability by primary aerodynamic controls alone is demonstrated during the take-off run to be adequate to permit proceeding safely with the take-off using average piloting skill, when the critical engine is suddenly made inoperative.

(b) The take-off safety speed V_L , in terms of calibrated air speed, shall be selected by the applicant so as to permit the gradient of climb required in section 4T.120 (a) and (b), but it shall not be less than:

(1) 1.2 V_S for two-engine propeller-driven airplanes and for airplanes without propellers which have no provisions for obtaining a significant reduction in the one-engine-inoperative power-on stalling speed;

FIGURE 19-1. LANDING TIME DELAYS

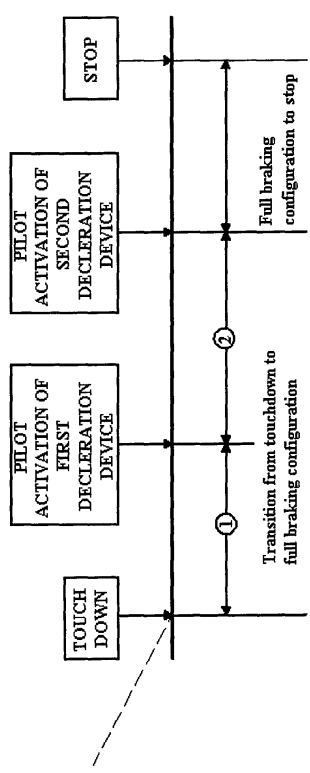

(i) ① This segment represents the flight test measured average time from touchdown to pilot activation of the first deceleration device. For AFM data expansion, use the longer of 1 second or the test time.

(ii) ② This segment represents the flight test measured average test time from pilot activation of the first deceleration device to pilot activation of the second deceleration device. For AFM data expansion, use the longer of 1 second or the test time.

(iii) Step ② is repeated until pilot activation of all deceleration devices has been completed and the airplane is in the full braking configuration.

(4) For approved automatic deceleration devices (e.g., autobrakes or auto-spoilers, etc.) for which performance credit is sought for AFM data expansion, established times determined during certification testing may be used without the application of the 1-second minimum time delay required in the appropriate segment above.

(5) It has been considered acceptable to expand the airborne portion of the landing distance in terms of a fixed airborne time, independent of airplane weight or approach speed.

(6) Assumptions to be made in assessing the effect of wind on landing distance are discussed in paragraph 3 of this AC.

h. Parametric Analysis Data Reduction. The following is an acceptable method of converting the test data to a mathematical model for the parametric analysis method of air distance described in paragraph 19b(3).

Test Data for Each Test Point:

- R/S_{50} = Rate of sink at 50 ft. above landing surface, Ft/Sec
- R/S_{TD} = Rate of sink at touchdown, Ft/Sec
- V_{50} = True airspeed at 50 ft. above landing surface, Ft/Sec
- V_{TD} = True airspeed at touchdown, Ft/Sec
- t = Air time 50 ft. to touchdown, Sec

The multiple linear regression analysis as outlined below is used to solve for the constant of the two independent variable equations:

$$50/t = a + b(R/S_{50}) + c(R/S_{TD})$$

To maintain the same units for all variables, the dependent variable is chosen as 50/t.

1. The provisions of Part 4b of the Civil Air Regulations, effective on the date of application for type certificate; and such of the provisions of all subsequent amendments to Part 4b, in effect prior to August 27, 1957, as the Administrator finds necessary to insure that the level of safety of turbine-powered airplanes is equivalent to that generally intended by Part 4b.

2. In lieu of sections 4b.110 through 4b.125, and 4b.743 of Part 4b of the Civil Air Regulations, the following shall be applicable:

PERFORMANCE

4T.110 General.

(a) The performance of the airplane shall be determined and scheduled in accordance with, and shall meet the minima prescribed by, the provisions of sections 4T.110 through 4T.123. The performance limitations, information, and other data shall be given in accordance with section 4T.743.

(b) Unless otherwise specifically prescribed, the performance shall correspond with ambient atmospheric conditions and still air. Humidity shall be accounted for as specified in paragraph (c) of this section.

(c) The performance as affected by engine power and/or thrust shall be based on a relative humidity of 80 percent at and below standard temperatures and on 34 percent at and above standard temperatures plus 50° F. Between these two temperatures the relative humidity shall vary linearly.

(d) The performance shall correspond with the propulsive thrust available under the particular ambient atmospheric conditions, the particular flight condition, and the relative humidity specified in paragraph (c) of this section. The available propulsive thrust shall correspond with engine power and/or thrust not exceeding the approved power and/or thrust less the installation losses and less the power and/or equivalent thrust absorbed by the accessories and services appropriate to the particular ambient atmospheric conditions and the particular flight condition.

4T.111 Airplane configuration, speed, power, and/or thrust; general.

(a) The airplane configuration (setting of wing and cowl flaps, air brakes, landing gear, propeller, etc.), denoted respectively as the takeoff, en route, approach, and landing configurations, shall be selected by the applicant except as otherwise prescribed.

(b) It shall be acceptable to make the airplane configurations variable with weight, altitude, and temperature, to an extent found by the Administrator to be compatible with operating procedures required in accordance with paragraph (c) of this section.

(c) In determining the accelerate-stop distances, take-off flight paths, take-off distances, and landing distances, changes in the airplane's configuration and speed, and in the power and/or thrust shall be in accordance with procedures established by the applicant for the operation of the airplane in service, except as otherwise prescribed. In addition, procedures shall be established for the execution of balked landings and missed approaches associated with the conditions prescribed in section 4T.119 and 4T.120(d), respectively. All procedures shall comply with the provisions of subparagraphs (1) through (3) of this paragraph.

(1) The Administrator shall find that the procedures can be consistently executed in service by crews of average skill.

(2) The procedures shall not involve methods or the use of devices which have not been proven to be safe and reliable.

(3) Allowance shall be made for such time delays in the execution of the procedures as may be reasonably expected to occur during service.

4T.112 Stalling speeds.

The test values of all the test points, 1 through n, are processed as follows, where n equals the number of test points and R1 through R13 are the regression coefficients:

$$R1 = \sum_{i=1}^n R/S_{50}$$

$$R2 = \sum_{i=1}^n (R/S_{50})^2$$

$$R3 = \sum_{i=1}^n R/S_{50}$$

$$R4 = \sum_{i=1}^n (R/S_{50})^2$$

$$R5 = \sum_{i=1}^n (R/S_{50})(R/S_{50})$$

$$R6 = \sum_{i=1}^n (50/t)$$

$$R7 = \sum_{i=1}^n (R/S_{50})(50/t)$$

$$R8 = \sum_{i=1}^n (R/S_{50})(50/t)$$

$$R9 = (n)(R2)-(R1)^2$$

$$R10 = (n)(R8)-(R3)(R6)$$

$$R11 = (n)(R5)-(R1)(R3)$$

$$R12 = (n)(R7)-(R1)(R6)$$

$$R13 = (n)(R4)-(R3)^2$$

$$c = ((R9)(R10)-(R11)(R12))/((R9)(R13)-(R11)^2)$$

$$b = ((R12)-(c)(R11))/R9$$

In the same manner, determine the values of the constants, a, b, and c, in an equation for speed reduction between 50 ft. and touchdown by replacing 50ft with (V_{50}/V_{mp}) for each test run.

After determining the values of the constants, the two equations are used to calculate the time from 50 ft. to touchdown and V_{50}/V_{mp} for the desired conditions of -3.5 degrees flight path and $R/S_{50} = 8$ ft/Sec. The R/S_{50} is calculated from the approach path and V_{50} .

After V_{mp} is determined, the air distance may be determined for the average flare speed and t.

compliance for passenger operations). Although it appeared that previous Board pronouncements regarding this general principle as well as the explanation contained in the preamble to SR-422 would make the issue quite clear, it has come to the Board's attention that there is still some misunderstanding of this matter. Apparently this misunderstanding stems from the fact that SR-422 prescribes operating rules for air carrier operations which contain both the "certificate limitations" and the "operating limitations" while no prescription is given to non-air-carrier operations; thus giving an impression that not even the "certificate limitations" are applicable to non-air-carriers. The inclusion of "certificate limitations" for air carrier operations with the "operating limitations" was meant only to provide the operators with the convenience of having together the complete prescription of the applicable performance limitations, notwithstanding that such an inclusion, in fact, duplicates the general requirement of compliance with the "certificate limitations" contained in the Airplane Flight Manual. In view of the possible misunderstanding which might exist from the aforementioned inclusion, there are included in this regulation the same "certificate limitations" for application to all operations under the provisions of Part 43 of the Civil Air Regulations.

In addition, other changes of a minor nature are included herein, the most significant of which is the generalization of the stall speed V_s eliminating reference to V_{s0} and V_{s1} .

Of the changes to SR-422 made in this regulation, there are a number which might require further consideration as studies continue and as additional experience is gained with the application of these new rules. Several of these involve new concepts with which U.S. operators have had little or no experience. These entail the requirements relative to unbalanced field lengths with respect to clearways, to the rotational speed, and to the all-engine take-off distance. Strong representation has been made to the Board to the effect that the numerical factors applicable to the aforementioned rules are too high and should be reduced pending further experience. The Board considers that it would not be in the public interest to reduce any of these factors until such time as further experience indicates that they are in fact overly conservative. Realizing, however, that these issues are of considerable importance in prescribing a practicable level of performance, the Board stands ready to reconsider the relevant provisions of this regulation at such time as substantiating information is received.

There are areas other than those previously mentioned where additional refinement of details may be advisable. This is so particularly in the case of the requirements pertaining to the landing stage of flight, to the take-off lateral clearances, and to the two-engine inoperative en route gradient margin. It is anticipated that, after further study of the regulation and especially after its application in the design, certification, and operation of forthcoming turbine-powered airplanes, the desirability of changes may become more apparent. It is the intent of the Board to consider without delay such changes as might be found necessary. Only after the provisions of this Special Civil Air Regulation are reasonably verified by practical application will the Board consider incorporating them on a more permanent basis into Parts 4b, 40, 41, 42, and 43 of the Civil Air Regulations.

This Special Civil Air Regulation is not intended to compromise the authority of the Administrator under section 4b.10 to impose such special conditions as he finds necessary in any particular case to avoid unsafe design features and otherwise to insure equivalent safety.

Interested persons have been afforded an opportunity to participate in the making of this regulation (23 F.R.2139), and due consideration has been given to all relevant matter presented.

In consideration of the foregoing, the Civil Aeronautics Board hereby makes and promulgates the following Special Civil Air Regulation, effective July 2, 1958:

Contrary provisions of the Civil Air Regulations notwithstanding, all turbine-powered transport category airplanes for which a type certificate is issued after August 27, 1957, shall comply with Special Civil Air Regulation No. SR-422 or, alternatively, with the following provisions, except that those airplanes for which a type certificate is issued after September 30, 1958, shall comply with the following provisions:

requiring the landing configuration during the climb after a balk is unduly conservative, consideration was given to a proposal to permit showing of compliance with the 4.0 percent gradient of climb in the configuration which would exist 5 seconds after the initiation of the climb. Further study of this proposal indicated that such a rule would tend to introduce complications in design and lead to less favorable operating procedures which ultimately would not contribute to safety. One of the most important factors in connection with this configuration is the response of the engines to throttle movement. Therefore, there is a provision which requires that the power used in showing compliance with the climb gradient be that power or thrust attained 8 seconds after initiation of movement of the power controls to the take-off position from the minimum flight idle position. In addition, for consistency with the procedures used for determining the landing distance, the speed limitation of 1.4 V_0 is reduced to 1.3 V_0 . Concern has been indicated to the effect that any reduction in the prescribed gradient of 1.0 percent might not insure in all cases the ability of the airplane to continue a safe climb after a balk. To provide a further safeguard, the take-off weight-altitude-temperature limitations (WAT limitations stemming from the application of the one-engine-inoperative take-off climb requirements) are being made applicable to the maximum landing weight at the airport of landing. In the past, the landing weight limitations were applicable to the airport of destination but not to the weather alternates. This regulation makes both the take-off weight and landing weight limitations equally applicable to the airport of destination and the weather alternates. In view of the aforementioned changes, a reduction of the required climb gradient from 4.0 to 3.2 percent is justified and included in this regulation.

In addition to the substantive changes which have been discussed, there are three significant changes of a clarifying nature. The first deals with the determination of the landing distance as affected by devices or means other than wheel brakes. There is included a provision similar to the one applicable to the accelerate-stop distance for application to the landing distance. This provision permits the use of means other than wheel brakes in the determination of the landing distance. Additionally, there is a change to the provision which requires in some cases the determination of the landing distance with one engine inoperative. It is believed that the new requirement expresses the intent more clearly. One of the more obvious applications of this provision is in respect of turbo-propeller airplanes. Such airplanes usually are landed with the propellers in a relatively high drag position. If one of the engines becomes inoperative, its propeller would be expected to be in a relatively low drag position with the consequence of a longer landing distance than with all engines operating. In such a case it is required that the landing distance be determined with one engine inoperative unless use could be made by the crew of other means (e.g., reverse thrust not otherwise considered in determining the landing distance) which would reduce the landing distance at least to that determined for all-engine operation.

The second clarification being included deals with the provision setting forth the procedures which must be included in the Airplane Flight Manual. This provision in SR-422 does not make clear what procedures are involved and whether the procedures are considered to be limitations on the operation of the airplane. The clarification in language specifies that the procedures which are included with the performance limitations shall be considered only as guidance material.

The third clarification concerns the applicability of the performance limitations prescribed in SR-422. These consist of the "certificate limitations" and the "operating limitations." The former relate to maximum take-off and landing weights, minimum take-off distances, accelerate-stop distances, and the operational limits imposed upon the airplane. These limitations, being part of the conditions of the type and airworthiness certificates, must be complied with at all times irrespective of the type of operation being conducted (e.g., air carrier, private, cargo). The "operating limitations," distinct from the "certificate limitations," are only applicable when required by the operating parts of the regulations (Parts 40, 41, and 42 require

Example:

Test Data:

Run	R/S_{50}	R/S_{TD}	V_{50}	V_{TD}	L
1	13.4		6.1	219	214
2	10.9		1.8	223	218
3	7.9		5.8	209	201
4	8.3		2.3	213	206
5	9.8		4.1	218	212

Results:

$$50ft = 1.0432 + .3647(R/S_{50}) + .4917(R/S_{TD})$$

$$V_{50}/V_{TD} = 1.05508 - .003198(R/S_{50}) + .001684(R/S_{TD})$$

For conditions of $V_{50} = 220$, flight path = -3.5 degrees, $R/S_{TD} = 8.0$, the resultants are:

$$R/S_{50} = 13.43 \quad V_{50}/V_{TD} = 1.0256$$

$$t = 5.063 \text{ sec.} \quad \text{Air Distance} = 1100 \text{ ft.}$$

Section 3. CONTROLLABILITY AND MANEUVERABILITY

20. GENERAL - § 25.143.

a. Explanation. The purpose of § 25.143 is to verify that any operational maneuvers conducted within the operational envelope can be accomplished smoothly with average piloting skill and without exceeding any airplane structural limits. Control forces should not be so high that the pilot cannot safely maneuver the airplane. Also, the forces should not be so light that it would take exceptional skill to maneuver the airplane without over-stressing it or losing control. The airplane response to any control input should be predictable to the pilot.

(1) The maximum forces given in the table in § 25.143(c) for pitch and roll control for short term application are applicable to maneuvers in which the control force is only needed for a short period. Where the maneuver is such that the pilot will need to use one hand to operate other controls (such as the landing flare or a go-around, or during changes of configuration or power resulting in a change of control force that must be trimmed out) the single-handed maximum control forces will be applicable. In other cases (such as takeoff rotation, or maneuvering during en route flight), the two-handed maximum forces will apply.

(2) Short-term and long-term forces should be interpreted as follows:

(i) Short-term forces are the initial stabilized control forces that result from maintaining the intended flight path following configuration changes and normal transitions from one flight condition to another, or from regaining control following a failure. It is assumed that the pilot will take immediate action to reduce or eliminate such forces by re-trimming or changing configuration or flight conditions, and consequently short-term forces are not considered to exist for any significant duration. They do not include transient force peaks that may occur during the configuration change, change of flight conditions, or recovery of control following a failure.

(ii) Long-term forces are those control forces that result from normal or failure conditions and that cannot readily be trimmed out or eliminated.

(3) Under the general requirements of § 25.143(a) for the airplane to "be safely controllable and maneuverable....," the potential for tailplane stall should be investigated. Elevator hinge moment becomes more sensitive to angle of attack as the tailplane stall is approached. This is particularly noticeable with elevators having significant aerodynamic balancing (leading edge and/or horn balance). In flight, these effects become apparent by lightening stick pull forces in stall maneuvers and lightening stick push forces in nose down pitching maneuvers. Tailplane leading edge surface condition and deposits of frost and ice can also have a significant effect on the available angle of attack range resulting in decreased tailplane stall margins. The loss of control, transient or sustained, due to flow separation at the tailplane, can thus occur with both manually operated and irreversible powered controls. Experience has shown that airplanes with non-powered elevators are the most at risk to encounter the phenomenon of large stick-force changes, but it is considered that all airplanes should be assessed for controllability problems in this respect. The possibility of encountering a tailplane stall condition is increased considerably during operations in icing conditions. Experience has shown that even a thin layer of rough *sandpaper* ice on the tailplane surfaces can cause longitudinal control problems. Consequently, a pushover maneuver, similar to that described in paragraph 20e, should be evaluated with regard to tailplane stall, with expected in-service frost and ice accretions present on the tailplane surfaces. The applicant must determine the critical icing accretion with regard to location, shape, thickness, and texture with FAA concurrence. For airplanes unlikely to be critical in certain icing conditions, it may be possible to show adequate longitudinal controllability by means other than flight test (see paragraph 20x(1)(v)).

(4) In conducting the controllability and maneuverability tests of §§ 25.143, 25.145 and 25.147, consideration should be given to the requirements of § 25.671(c). Section 25.671(c) requires the airplane to "be shown by analysis, tests, or both, to be capable of continued safe flight and landing after any...failures or jamming in the flight control systems and surfaces (including trim, lift, drag, and feel systems), within the normal flight envelope...." This would include any single failure, or any combination of failures not shown to be extremely improbable. The specific concerns for possible flight test evaluation are as follows:

(i) Unless safe flight characteristics are demonstrated with functionally related high lift or drag devices retracted on one side of the airplane and extended on the other, the motion of the devices on opposite sides

airport. Obscure as is the significance of this altitude operationally, the altitude of 1,500 feet has worldwide precedent of being used as the altitude above the airport at which, generally, IFR approaches are initiated and go-around procedures executed. For this reason, the changes made to the prescribed performance criteria above the airport for the one- and two-engine-inoperative en route requirements. It is not anticipated that these changes will create any problems with respect to the en route stages of flight; however, it is realized that a further extension of the take-off path might add to the problem of obtaining accurate data on obstacles relatively distant from the airport. The Board finds that the extension of the flight path to 1,500 feet is warranted in light of the operational significance of this altitude and because the extended flight paths will provide more fully for adequate terrain clearance at the end of the take-off path.

There is included a change with respect to the take-off path whereby the take-off flight path is established as starting from a 35-foot height at the end of the take-off distance and a net take-off flight is prescribed for operational use. This latter change is for consistency with the specification of net flight paths for the en route stages of flight and to simplify determination of obstacle clearances operationally. The net flight path is specified to be the actual flight path diminished by a gradient of 1.0 percent. It is intended that the net flight path be obtained from the gross flight path by simple geometric means.

The change in the altitude from 1,000 to 1,500 feet previously mentioned, as well as a re-evaluation in other respects of some of the climb gradients in SR-422, justify certain changes. The gradients of 1.4 and 1.8 applicable to the take-off path and the final take-off climb are being reduced to 1.2 and 1.7 for two-engine and four-engine airplanes, respectively. In addition, the gradients 1.4 and 1.8 in the one-engine-inoperative en route case are being reduced to 1.1 and 1.6, respectively.

Changes are made with respect to the one-engine-inoperative take-off climb by interrelating more realistically the prescribed airplane configuration, weight, and power. These changes, in effect, permit meeting the prescribed gradients of climb at slightly higher airplane weights than would be possible under the presently effective provisions.

There is included a change to the provisions applicable to the one-engine-inoperative take-off climb with landing gear extended which increases the prescribed minimum gradient from substantially zero to 0.5 percent for four-engine airplanes. This change is made to attain consistency in the difference between gradients applicable to twins and fours.

Changes are incorporated in connection with the two-engine-inoperative en route requirement. Representations have been made that the gradient of 0.5 percent now prescribed is unduly conservative. On the other hand, it has been pointed out that the fuel requirements for this case are not realistically covered. Both of these contentions warrant consideration and changes are included which reduce the margin gradient from 0.6 to 0.5 percent, reduce the prescribed altitude from 5,000 to 2,000 feet, and require scheduling the flight so that there is sufficient fuel on board to reach the airport and subsequently to fly for 15 minutes at cruise power or thrust.

Changes are also made relative to the approach and landing stages of flight. There is a new provision which requires the establishment of procedures for the execution of missed approaches and balked landings. A question has been raised as to whether the speed limitation of 1.5 Vs applicable to the approach condition is realistically related to the normal day-in and day-out landing procedures. To insure that it will be so related, it is required that the speed used for demonstrating the approach climb be established consistent with the landing procedures, but that it not exceed 1.5 Vs. In addition, the approach gradient of 2.8 percent prescribed for four-engine airplanes is being reduced to 2.7 percent to obtain consistency in the differences between gradients applicable to twins and fours.

A change is made to the "all-engines-operating landing climb" provisions which now require a 4.0 percent gradient of climb in the landing configuration. On the premise that

having a marked difference in effect on the resultant level of performance. The issue in this matter is whether or not the airplane should be permitted to lift off the runway at some speed below V_2 . Because of the increased acceleration of turbine-powered airplanes, the tendency to overshoot the lift-off speed will be greater than on piston-engine airplanes and this tendency increases with the reduction in weight of the airplane. To restrict lift-off to the minimum take-off safety speed V_2 would unduly extend the take-off distance in cases where such overshooting of speed occurs. Such a restriction would be unnecessarily conservative and would not reflect realistic take-off procedures. For these reasons this regulation permits the airplane to lift off the ground at a speed lower than the V_2 speed, but prescribes certain limiting conditions. The lift-off speed is related to a rotational speed V_k which must not be less than 95 percent of the minimum V_2 speed and must be 10 percent greater than a speed at which no hazardous characteristics are displayed by the airplane, such as a relatively high drag condition or a ground stall. The V_2 speed has been re-defined to take into account the increment in speed arising from overshoot tendencies. Under the new definition, the minimum V_2 speed corresponds with the minimum take-off safety speed as now defined in SR-422. With respect to the take-off path, the V_2 speed is required to be attained prior to reaching a height of 35 feet above the take-off surface and thus is related to the selection of the rotational speed. Further, there is a revision which requires V_2 to be maintained as close as practicable at a constant value from the 35-foot point to a height of 400 feet above the take-off surface. This speed is the speed at which the prescribed minimum take-off gradients must be met.

There is introduced in this regulation the concept of unbalanced take-off field lengths. SR-422 does not preclude unbalancing of field lengths, provided that the unbalancing is within the length of the runway. Other countries have employed unbalancing with respect to so-called "stopways" and "clearways". It appears that United States operators ultimately will find it advantageous to resort to the use of unbalancing, but probably not to the same extent as practiced in other countries. On the premise that only clearways will be utilized, the amendments have been formulated accordingly. Clearways, as defined herein, are areas not suitable for stopping the airplane in the event of an aborted take-off, but adequate to provide additional take-off distance for climb-out. To safeguard operations utilizing clearways, there is introduced the concept of a take-off run which operationally relates to the determination of the minimum runway length required. The take-off run is defined as the greater of the horizontal distances along the take-off path to a given point with one engine inoperative or with all engines operating, with a margin of 15 percent being added to the latter. The take-off run is measured from the beginning of take-off to a point equidistant between the point where the airplane lifts off and the point where a height of 35 feet is reached. The required runway length must not be less than the take-off run nor less than the accelerate stop distance.

According to the definition given, a clearway is subjected to the control of the airport authorities. It is not intended, however, that there be ownership by the airport authorities of the area in which the clearway lies. The objective for requiring control by the airport authorities is to insure that no flight will be initiated using a clearway unless it is determined with certainty that no movable obstacle will exist within the clearway when the airplane flies over.

It is anticipated that the introduction of clearways will offer further possibilities of increasing the utility of existing airport facilities in this country. When such areas can be integrated into existing facilities, economical benefits will accrue to the community and the operators. In addition, since clearways are presently available at some of the airports in other countries, United States operators will have the opportunity of taking advantage of such facilities.

There are included changes with respect to the prescribed minimum altitude of 1,000 feet relative to the take-off path and to the one-engine-inoperative and two-engine-inoperative requirements applicable to the vicinity of the airport. Heretofore, the Civil Air Regulations have incorporated the reference altitude of 1,000 feet in respect of performance criteria over the

of the plane of symmetry must be synchronized by a mechanical interconnection or approved equivalent means as required by § 25.701 (Flap and slat interconnection).

(ii) The "safe flight characteristics" referred to in paragraph (i), above, are interpreted as being the retention of adequate stall margins and controllability, following the described failure conditions, without requiring exceptional piloting skill or strength.

(iii) Additionally, no hazardous change in altitude, or attitude, should occur during transition to the asymmetric condition considering likely transition rates.

(iv) Cases of primary flight control jams (i.e.; pitch, roll, and yaw) to be considered should include the following:

(A) For pitch controls:

(1) A jam at the initiation of the takeoff rotation, and

(2) A jam at the most critical peak elevator angle reached during a normal rotation maneuver.

(B) For roll and yaw controls, considered separately, a jam in the control position necessary to initiate all normal turns.

b. General Test Requirements. Compliance with § 25.143 is primarily a qualitative determination by the pilot during the course of the flight test program. The control forces required and airplane response should be evaluated during changes from one flight condition to another and during maneuvering flight. The forces required should be appropriate to the flight condition being evaluated. For example, during an approach for landing, the forces should be light and the airplane responsive in order that adjustments in the flight path can be accomplished with a minimum of workload. In cruise flight, forces and airplane response should be such that inadvertent control input does not result in exceeding limits or in undesirable maneuvers. Longitudinal control forces should be evaluated during accelerated flight to ensure a positive stick force with increasing normal acceleration. Forces should be heavy enough at the limit load factor to prevent inadvertent excursions beyond the design limit. Sudden engine failures should be investigated during any flight condition or in any configuration considered critical, if not covered by another section of Part 25. Control forces considered excessive should be measured to verify compliance with the maximum control force limits specified in § 25.143(c). Allowance should be made for delays in the initiation of recovery action appropriate to the situation.

c. Controllability Following Engine Failure. Section 25.143(b)(1) requires the airplane to be controllable following the sudden failure of the critical engine. To show compliance with this requirement, the demonstrations described in paragraphs (1) and (2), below, should be made with engine failure (simulated by fuel cuts) occurring during straight, wings level flight. To allow for likely in-service delays in initiating recovery action, no action should be taken to recover control for two seconds following pilot recognition of engine failure. The recovery action should not necessitate movement of the engine, propeller, or trim controls, and should not result in excessive control forces. Additionally, the airplane will be considered to have reached an unacceptable attitude if the bank angle exceeds 45 degrees during the recovery. These tests may be conducted using throttle slams to idle, with actual fuel cuts repeated only for those tests found to be critical.

(1) At each takeoff flap setting at the initial all-engine climb speed (i.e., $V_2 + 10$ knots) with:

(i) All engines operating at maximum takeoff power or thrust prior to failure of the critical engine;

(ii) All propeller controls (if applicable) in the takeoff position;

(iii) The landing gear retracted; and

(iv) The airplane trimmed at the prescribed initial flight condition.

(2) With the wing flaps retracted at a speed of $1.3 V_2$ with:

SPECIAL CIVIL AIR REGULATION NO. SR-422A

Adopted: July 2, 1958
Effective: July 2, 1958

Turbine-Powered Transport Category Airplanes of Current Design

On July 23, 1957, the Board adopted Special Civil Air Regulation No. SR-422 which sets forth airworthiness requirements applicable to the type certification and operation of turbine-powered transport category airplanes for which a type certificate is issued after August 27, 1957. Included in that regulation was a new set of performance requirements, with respect to which the Board indicated that consideration would be given to any changes found necessary as a result of further study and experience. The preamble to SR-422 contains the relevant considerations leading to its promulgation and is considered to provide the basic background for this regulation.

Since the adoption of SR-422, considerable study has been devoted to the new performance requirements by all interested parties. As a result of these studies and of further experience gained in the design, certification, and operation of turbine-powered airplanes, certain issues with respect to SR-422 require re-evaluation. This regulation reflects the resolution of most of the outstanding issues in the light of the best information presently available to the Board.

The following provisions of this regulation differ from, or are additional to, the provisions of SR-422: Introductory paragraph; item 1; sections 4T.111(c); 4T.112; 4T.114 (b), (b)(1), (b)(4), and (c); introductory paragraph of 4T.116; 4T.116 (b), (c), and (g); 4T.117; 4T.117a; 4T.119; 4T.120 (a), (a)(1), (b), (b)(1), (c), (c)(2), (c)(3), (d), and (d)(3); 4T.121 (a) and (b); introductory paragraph of 4T.122; 4T.122 (b), (f), and (g); 4T.123 (a)(1), (a)(2), (a)(3), and (b); 4T.1743(c); 40T.81 (b) and (c); 40T.82; 40T.83 (a)(2)(iii), (b)(2), and (b)(2)(ii); item 4; and item 5. Of these provisions, the following differ from those proposed in Civil Air Regulations Draft Release No. 58-6: sections 4T.111(c); 4T.112(a)(4); 4T.114 (b)(4), (c), (c)(2), (c)(3), and (c)(4); 4T.116 (c) and (e); 4T.117 (b)(1) and (b)(2); 4T.119(a); 4T.120(a); 40T.81(c) and 43T.11(c).

With respect to the applicability of this regulation, experience with certification under SR-422 indicates that a lead time of about two months between the date of adoption of the regulation and the date of issuance of the type certificate should provide a reasonable period of time within which to show compliance with this regulation. In view of this, and in the interest of having uniform regulations applicable to most of the turbine-powered airplanes, it is considered advisable to have this regulation apply to all such airplanes for which a type certificate is issued after September 30, 1958. Turbine-powered transport category airplanes for which a type certificate is issued on or prior to September 30, 1958, may comply with the provisions of this regulation in lieu of SR-422. If this option is exercised, it is intended that compliance be shown with all the provisions of this regulation and it is not intended to permit a showing of compliance with portions of this regulation and portions of SR-422.

The provisions of this regulation involve the following technical issues:

A substantive change is made by introducing an all-engines-operating take-off in establishing the take-off distance. Presently, the take-off distance is based only on a one-engine-out take-off. To insure that an adequate margin of safety will exist for day-in and day-out operations, the minimum take-off distance is being related to both the one-engine-inoperative distance now prescribed and to the distance with all engines operating, with a factor of 1.15 being applied to the latter.

There are also included important changes with respect to the speeds applicable to the take-off path. The provisions of SR-422 prescribe that the airplane shall be accelerated on or near the ground to the speed V_2 . This provision has been subject to varying interpretations

(i) All engines operating at maximum continuous power or thrust prior to failure of the critical engine;

(ii) All propeller controls in the enroute position;

(iii) The landing gear retracted; and

(iv) The airplane trimmed at the prescribed initial flight condition.

d. Airplane-Pilot Coupling (A-PC).

(1) Explanation.

(i) Sections 25.143(a) and (b) require that the airplane be safely controllable and maneuverable without exceptional piloting skill and without danger of exceeding the airplane limiting load factor under any probable operating conditions. Service history events have indicated that modern transport category airplanes can be susceptible to airplane-pilot coupling under certain operating conditions and would not meet the intent of this requirement.

(ii) The classic airplane-pilot coupling (A-PC) situation, commonly referred to as "pilot-induced oscillations (PIO)," is considered to occur when some airplane's response metric is approximately 180 degrees out of phase with the pilot's control input. However, A-PC events with 180 degrees phase relationships are not the only conditions in which the airplane may exhibit closed-loop (pilot-in-the-loop) characteristics that are unacceptable for operation within the normal, operational, or limit flight envelopes. Others include unpredictability of the airplane's response to the pilot's control input. This may be due to nonlinearities in the control system, actuator rate or position limiting not sensed by the pilot through the flight controls, or changing pitch response at high altitude as the airplane maneuvers into and out of Mach buffet. Artificial trim and feel systems which produce controllers with too small a displacement and light force gradients may also lead to severe over control. This is especially true in a dynamic environment of high altitude turbulence or upsets in which the autopilot disconnects. This places the airplane in the hands of the unsupervising pilot in conditions of only a small g or airspeed margin to buffet onset and with very low aerodynamic damping. These characteristics, while not 180° out of phase PIOs per se, may be hazardous and should be considered under the more general description of airplane-pilot coupling tendencies

(iii) Some of the A-PC tendency characteristics described in paragraph (ii) above are attributes of transport airplanes (e.g., low frequency, short period, large response lags) that are recognized by part 25. Limits are placed on some of these individual attributes by part 25 (e.g., stick force per g, heavily damped short period) to assure satisfactory open-loop characteristics. However, service reports from recent years have indicated that certain operating envelope conditions, combined with triggering events, can result in airplane-pilot coupling incidents. Some of the conditions that have led to these A-PCs include fuel management systems that permit extended operations with a center of gravity at or near the aft limit, operating at weight/speed/altitude conditions that result in reduced margins to buffet onset combined with tracking tasks such as not exceeding speed limitations and severe buffet due to load factor following an upset, and control surface rate or position limiting.

(iv) This service experience has shown that compliance with only the quantitative, open-loop (pilot-out-of-the-loop) requirements does not guarantee that the required levels of flying qualities are achieved. Therefore, in order to ensure that the airplane has achieved the flying qualities required by §§ 25.143(a) and (b), the airplane must be evaluated by test pilots conducting high-gain (wide-bandwidth), closed-loop tasks to determine that the potential of encountering adverse A-PC tendencies is minimal.

(v) For the most part, these tasks must be performed in actual flight. However, for conditions that are considered too dangerous to attempt in actual flight (i.e., certain flight conditions outside of the operational flight envelope, flight in severe atmospheric disturbances, flight with certain failure states, etc.), the closed loop evaluation tasks may be performed using a motion base high fidelity simulator if it can be validated for the flight conditions of interest.

(2) Special Considerations.

off if an alternate airport is designated which permits compliance with paragraph (b) of this section.

(b) *Alternate airport.* No airport shall be designated as an alternate airport in a dispatch release unless the airplane at the weight anticipated at the time of arrival at such airport can comply with the provisions of paragraph (a) of this section, provided that the airplane can be brought to rest within 70 percent of the effective length of the runway.

(i) The certification team should understand the flight control system and airplane design.
(ii) The applicant should explain why the design is not conducive to an A-PC problem and how this is to be shown in both developmental and certification flight tests.

(iii) The applicant should explain what has been done during the development flight test experience and any design changes that were required for A-PC problems.

(iv) The certification flight test program should be tailored to the specific airplane design and to evaluate the airplane in conditions that were found to be critical during its development program and A-PC analytical assessment.

(v) The FAA flight test pilots should also continuously evaluate the airplane for A-PC tendencies during the certification program in both the airplane and simulator. This evaluation should include both normal and malfunction states; all certification flight test points; transitions between and recoveries from these flight test points; and normal, crosswind, and offset landing task evaluations.

(vi) Since the evaluation of flying qualities under §§ 25.143(a) and (b) is basically qualitative, especially evaluations of A-PC susceptibility, the high-gain tasks discussed herein should be accomplished by at least three test pilots. Use of other pilots can provide additional insights into the airplane handling qualities, but for the purpose of demonstrating compliance with this requirement the evaluation pilots should be trained test pilots.

(3) Procedures (Flight Test)

(i) Evaluation of the actual task performance achieved, e.g., flight technical error, is not recommended as a measure of proof of compliance. Only the pilot's rating of the A-PC characteristics is needed as described in paragraph 20d(6). The tasks are used only to increase the pilot's gain, which is a prerequisite for exposing A-PC tendencies. Although task performance is not used as proof of compliance, task performance should be recorded and analyzed to insure that all pilots seem to be attempting to achieve the same level of performance.

(ii) Tasks for a specific certification project should be based on operational situations, flight testing maneuvers, or service difficulties that have produced A-PC events. Task requirements for a specific project will be dictated by the particular airplane and its specific areas of interest as determined by the tailored flight test program mentioned above. Some of these include high altitude upset maneuvers, encounters with turbulence at high altitude in which the autopilot disconnects, crosswind/crossed control landings with and without one engine inoperative, and offset landings to simulate the operational case in which the airplane breaks out of Instrument Meteorological Conditions (IMC) offset from the glideslope and/or localizer beam and the pilot makes a rapid alignment correction. Tests should be conducted at or near the critical altitude/weight/e.g. combinations.

(iii) Tasks described here may be useful in any given evaluation and have proven to be operationally significant in the past. It is not intended that these are the only tasks that may be used or may be required depending on the scope and focus of the individual evaluation being conducted. Other tasks may be developed and used as appropriate. For example, some manufacturers have used formation tracking tasks successfully in the investigation of these tendencies. For all selected tasks, a build-up approach should be used and all end points should be approached with caution. Capture tasks and fine tracking tasks share many common characteristics but serve to highlight different aspects of any A-PC problem areas that may exist. In some cases, depending on individual airplane characteristics, it may be prudent to look at capture tasks first and then proceed to fine tracking tasks or combined gross acquisition (capture) and fine tracking tasks as appropriate.

(4) Capture Tasks.

(i) Capture tasks are intended to evaluate handling qualities for gross acquisition as opposed to continuous tracking. A wide variety of captures can be done provided the necessary cues are available to the pilot. Pitch attitude, bank angle, heading, flight path angle, angle of attack, and g captures can be done to evaluate different aspects of the airplane response. These capture tasks can give the pilot a general impression of the handling qualities of the airplane, but because they do not involve closed-loop fine tracking, they do not expose all of the problems that may arise in fine tracking tasks. Capture tasks should not be used as the only evaluation tasks.

(ii) For pitch captures, the airplane is trimmed for a specified flight condition. The pilot aggressively captures 5 degrees pitch attitude (or 10 degrees if the airplane is already trimmed above 5 degrees). The pilot then makes a series of aggressive pitch captures of 5 degree increments in both directions, and then continues this procedure with ten degree increments in both directions. An airplane with more capability can continue the procedure with larger pitch excursions. If possible, the initial conditions for each maneuver should be such that the airplane will remain within $\pm 1,000$ feet and ± 10 knots of the specified flight condition during the maneuver; however, large angle captures at high-speed conditions will inevitably produce larger speed and altitude changes. If the airplane should get too far from the specified condition during a task, it should be retrimmed for the specified condition before starting the next maneuver.

(iii) The other kinds of captures are usually done in a similar manner, with some minor differences. G captures can be done from a constant-g turn or pull ups and pushovers using ± 0.2 g and ± 0.5 g. Heading captures can be used to evaluate the yaw controller alone (usually small heading changes of 5 degrees or less).

(iv) Bank angle captures are also commonly done using bank-to-bank rolls. Starting from a 15 degree bank angle, the pilot aggressively rolls and captures the opposite 15 degree bank angle (total bank angle change of 30 degrees). The pilot then rolls back and captures 15 degrees bank in the original direction. This procedure should continue for a few cycles. The procedure is then repeated using 30 degree bank angles, and then repeated again using 45 degree bank angles. A variation of this is to capture wings-level from the initial bank condition.

(v) Where suitable, combined conditions could be used as described in the task shown in paragraph (vii), below, in which a target g and bank angle are tightly tracked until the target pitch attitude and heading are captured.

(vi) The following upset and/or collision avoidance maneuvers have been found to be effective in evaluating A-PC susceptibility when the airplane is flying at high altitude under conditions of low g to buffet onset, typically 0.3g. This emphasis on cruise susceptibility stems from operational experiences, but should not be interpreted as placing less emphasis on other flight phases:

(A) Trim for level flight at long-range cruise Mach number. Initiate a slight climb and slow the aircraft while leaving power set. Push the nose over and set up a descending turn with 30 to 40 degrees of bank and approximately 10 degrees nose below the horizon, or as appropriate, to accelerate to the initial trim speed. At the initial trim airspeed initiate a 1.5 g to 1.67 g (not to exceed deterrent buffet) pull up and establish a turn in the opposite direction to a heading which will intersect the initial course on which the airplane was trimmed. Establish a pitch attitude which will provide a stabilized climb back to the initial trim altitude. The pilot may use the throttles as desired during this maneuver and should pick a target g, bank angle, heading, and pitch attitude to be used prior to starting the maneuver. The target g and bank angle should be set and tightly tracked until the target pitch attitude and heading are obtained respectively. The stabilized steady heading climb should be tightly tracked for an adequate amount of time to allow the pilot to assess handling qualities, even through the initial trim altitude and course if required. The pilot should qualitatively evaluate the airplane during both the gross acquisition and fine tracking portions of this task while looking for any tendency towards A-PC in accordance with the criteria in paragraph 20d(6).

(B) This maneuver should be repeated in the nose-down direction by accelerating to MMO from the trim condition 10 degrees nose down and then recover as above.

(C) Trim for level flight as above. Initiate a 1.5 g to 1.67 g (not to exceed deterrent buffet) pull-up and approximately a 30 degree bank turn. Once the target g is set, transition the aircraft to approximately a 0.5 g pushover and reverse the turn to establish an intercept heading to the initial course. Using power as required, set up a stabilized steady heading descent to intercept the initial course and altitude used for the trimmed condition. The pilot may continue the heading and descent through the initial conditions to allow more tracking time if needed. Attempt to precisely set and track bank angle, g, heading, and pitch attitude as appropriate. The pilot should qualitatively evaluate the airplane during both the gross acquisition and fine tracking portions of this task while looking for an A-PC tendency in accordance with paragraph 20d(6).

(5) Five Tracking Tasks.

fix, except that the Administrator may authorize a procedure established on a different basis where adequate operational safeguards are found to exist.

(iii) The net flight path shall have a positive slope at 1,000 feet above the airport used as the alternate.

(iv) An approved method shall be used to account for winds which would otherwise adversely affect the flight path.

(v) Fuel jettisoning shall be permitted if the Administrator finds that the operator has an adequate training program, proper instructions are given to the flight crew, and all other precautions are taken to insure a safe procedure.

(vi) The alternate airport shall be specified in the dispatch release and shall meet the prescribed weather minima.

(vii) The consumption of fuel and oil after the engine becomes inoperative shall be that which is accounted for in the net flight path data shown in the Airplane Flight Manual.

(b) *Two engines inoperative.* No airplane shall be flown along an intended route except in compliance with either subparagraph (1) or subparagraph (2) of this paragraph.

(1) No place along the intended track shall be more than 90 minutes away from an airport at which a landing can be made in accordance with the provisions of section 40T.84(b), assuming all engines to be operating at cruising power.

(2) No airplane shall be taken off at a weight in excess of that which, according to the two-engine-inoperative en route net flight path data shown in the Airplane Flight Manual, will permit the airplane to continue flight from the point where two engines are assumed to fail simultaneously to an airport where a landing can be made in accordance with the provisions of section 40T.84(b), the net flight path having a positive slope at an altitude of at least 1,000 feet above all terrain and obstructions along the route within 5 miles on either side of the intended track or at an altitude of 5,000 feet, whichever is higher. The net flight path considered shall be for the ambient temperatures anticipated along the route. The provisions of subdivision (i) through (iii) of this subparagraph shall apply. (See secs. 4T.123(b) and 4T.743(b).)

(i) The two engines shall be assumed to fail at the most critical point along the route.

(ii) If fuel jettisoning is provided, the airplane's weight at the point where the two engines are assumed to fail shall be considered to be not less than that which would include sufficient fuel to proceed to the airport and to arrive there at an altitude of at least 1,000 feet directly over the landing area.

(iii) The consumption of fuel and oil after the engines become inoperative shall be that which is accounted for in the net flight path data shown in the Airplane Flight Manual.

40T.84 Landing limitations.

(a) *Airport of destination.* No airplane shall be taken off at a weight in excess of that which, in accordance with the landing distances shown in the Airplane Flight Manual for the elevation of the airport of intended destination and for the wind conditions anticipated there at the time of landing, would permit the airplane to be brought to rest at the airport of intended destination within 60 percent of the effective length of the runway from a point 50 feet directly above the intersection of the obstruction clearance plane and the runway. The weight of the airplane shall be assumed to be reduced by the weight of the fuel and oil expected to be consumed in flight to the airport of intended destination. Compliance shall be shown with the conditions of subparagraphs (1) and (2) of this paragraph. (See secs. 4T.123(b) and 4T.743(b).)

(1) It shall be assumed that the airplane is landed on the most favorable runway and direction in still air.

(2) It shall be assumed that the airplane is landed on the most suitable runway considering the probable wind velocity and direction and taking due account of the ground handling characteristics of the airplane and of other conditions (i.e., landing aids, terrain, etc.). If full compliance with the provisions of this subparagraph is not shown, the airplane may be taken

interpolations or computations give results substantially equaling in accuracy the results of a direct test.

40T.81 Airplane's certificate limitations.

- (a) No airplane shall be taken off at a weight which exceeds the take-off weight specified in the Airplane Flight Manual for the elevation of the airport and for the ambient temperature existing at the time of the take-off. (See sec. 4T.123(a) (1) and 4T.743(a).)
- (b) No airplane shall be taken off at a weight such that, allowing for normal consumption of fuel and oil in flight to the airport of destination, the weight on arrival will exceed the landing weight specified in the Airplane Flight Manual for the elevation of the airport of destination and for the ambient temperature anticipated there at the time of landing. (See secs. 4T.123(a) (2) and 4T.743(a).)
- (c) No airplane shall be taken off at a weight which exceeds the weight shown in the Airplane Flight Manual to correspond with the minimum distance required for take-off on the runway to be used. The take-off distance shall correspond with the elevation of the airport, the effective runway gradient, and the ambient temperature and wind component existing at the time of take-off. (See secs. 4T.123(a) (3) and 4T.743 (a).)
- (d) No airplane shall be operated outside the operational limits specified in the Airplane Flight Manual (See secs. 4T.123(a) (4) and 4T.742(a)).

40T.82 Take-off obstacle clearance limitations. No airplane shall be taken off at a weight in excess of that shown in the Airplane Flight Manual to correspond with a take-off path which clears all obstacles either by at least a height equal to $(35 + 0.01D)$ feet vertically, where D is the distance out along the intended flight path from the end of the runway in feet, or by at least 200 feet horizontally within the airport boundaries and by at least 300 feet horizontally after passing beyond the boundaries. In determining the allowable deviation of the flight path in order to avoid obstacles by at least the distances prescribed, it shall be assumed that the airplane is not banked before reaching a height of 50 feet as shown by the take-off path data in the Airplane Flight Manual, and that a maximum bank thereafter does not exceed 15 degrees. The take-off path considered shall be for the elevation of the airport, the effective runway gradient, and for the ambient temperature and wind component existing at the time of take-off. (See secs. 4T.123(b) and 4T.743(b).)

40T.83 En route limitations.

- (a) *One engine inoperative.* No airplane shall be taken off at a weight in excess of that which, according to the one-engine-inoperative en route net flight path data shown in the Airplane Flight Manual, will permit compliance with either subparagraph (1) or subparagraph (2) of this paragraph at all points along the route. The net flight path used shall be for the ambient temperatures anticipated along the route. (See secs. 4T.123(b) and 4T.743(b).)
 - (1) The slope of the net flight path shall be positive at an altitude of at least 1,000 feet above all terrain and obstructions along the route within 5 miles on either side of the intended track.
 - (2) The net flight path shall be such as to permit the airplane to continue flight from the cruising altitude to an alternate airport where a landing can be made in accordance with the provisions of section 40T.84 (b), the net flight path clearing vertically by at least 2,000 feet all terrain and obstructions along the route within 5 miles on either side of the intended track. The provisions of subdivisions (i) through (vii) of this paragraph shall apply.
 - (i) The engine shall be assumed to fail at the most critical point along the route.
 - (ii) The airplanes shall be assumed to pass over the critical obstruction following engine failure at a point no closer to the critical obstruction than the nearest approved radio navigational track.

- (i) These tasks may be used to assess the airplane's A-PC susceptibility when flying in turbulent atmospheric conditions. In this task, a tracking target is displayed which commands pitch and roll changes for the evaluation pilot to follow. Whatever visual cue is used (e.g., HUD, flight director, etc.), it should present the tracking task without filtering, smoothing, or bias. The pitch and roll commands should be combinations of steps and ramps. The sequence of pitch and roll commands should be designed so as to keep the airplane within $\pm 1,000$ feet of the test altitude and within ± 10 knots of the test airspeed. The sequence should be long enough and complex enough that the pilot cannot learn to anticipate the commands. The unfamiliarity is intended to help keep the test pilot's gain high and to preclude inadvertent pilot compensation while accomplishing the task. Such compensation, along with reduced gains, could mask any A-PC tendencies.

- (ii) Even though these fine tracking tasks will provide insight into A-PC susceptibility of a conventional airplane when flying in turbulence, other considerations apply to augmented airplane types. For example, structural load alleviation systems that use the same flight control surface as the pilot will limit the pilot's control authority in turbulent atmospheric conditions. Under these circumstances of rate or position limiting, A-PC tendencies will be more critical as previously discussed. Therefore, specific evaluations for turbulent atmospheric conditions with these systems operating are necessary for these airplane types.

- (iii) For single axis tasks, it has been found that aural commands given in a timed sequence provide an adequate cue in the event it is not possible to modify the flight director to display the pitch commands.

- (iv) Based on A-PC events seen in service, high altitude tracking tasks (with up to approximately $\pm 4^\circ$ pitch excursions from trim occurring at varying intervals of approximately 2 to 5 seconds) have been effective in evaluating A-PC susceptibility. These tasks have been used where the airplane is flying under conditions of low g margin to buffet onset. The following time history is a pictorial representation of a sample task in MIL-STD-1797A that has the desired attributes for high altitude A-PC evaluations:

FIGURE 20-1. SAMPLE PITCH TRACKING TASK

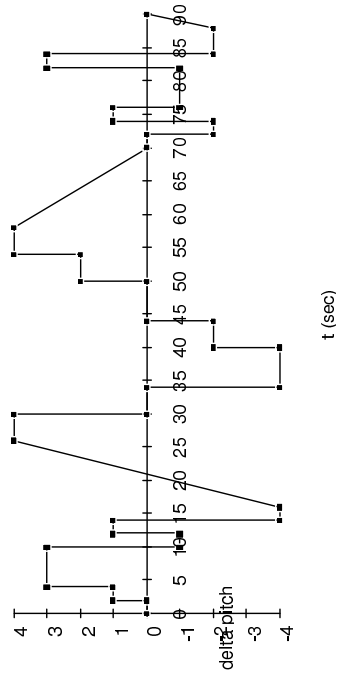

(6) A-PC Assessment Criteria.

- * Handling Qualities Rating Method (HQR/M). Tasks should be designed to focus on any A-PC tendencies that may exist. Figure 20-2 contains the descriptive material associated with A-PC characteristics and its relationship to the PIO Rating Scale called out in the U.S. Military Standard.
 - (i) The evaluation of an airplane for A-PC susceptibility will be conducted using the FAA Handling Qualities Rating Method (HQR/M). Tasks should be designed to focus on any A-PC tendencies that may exist. Figure 20-2 contains the descriptive material associated with A-PC characteristics and its relationship to the PIO Rating Scale called out in the U.S. Military Standard.
 - (ii) Figure 20-2 provides the FAA Handling Qualities Rating descriptions of airplane motions that may be seen during the conduct of specific A-PC tasks or during tests throughout the entire certification flight test program. The *italicized* phrases highlight major differences between rating categories in the table.

* FIGURE 20-2. A-PC RATING CRITERIA AND COMPARISON TO MIL STANDARD

FAA HQ RATING	A-PC CHARACTERISTICS DESCRIPTION	MIL
		1797A STD.
		PIO RATING SCALE
SAT	NO TENDENCY FOR PILOT TO INDUCE UNDESIRABLE MOTION. UNDESIRABLE MOTIONS (OVERSHOOTS) TEND TO OCCUR WHEN PILOT INITIATES ABRUPT MANEUVERS OR ATTEMPTS TIGHT CONTROL. THESE MOTIONS CAN BE PREVENTED OR ELIMINATED BY PILOT TECHNIQUE. (NO MORE THAN MINIMAL PILOT COMPENSATION REQUIRED)	1
		2
ADQ	UNDESIRABLE MOTIONS (UNPREDICTABILITY OR OVER CONTROL) EASILY INDUCED WHEN PILOT INITIATES ABRUPT MANEUVERS OR ATTEMPTS TIGHT CONTROL. THESE MOTIONS CAN BE PREVENTED OR ELIMINATED BUT ONLY AT SACRIFICE TO TASK PERFORMANCE OR THROUGH CONSIDERABLE PILOT ATTENTION AND EFFORT. (NO MORE THAN EXTENSIVE PILOT COMPENSATION REQUIRED)	3
CON	OSCILLATIONS TEND TO DEVELOP WHEN PILOT INITIATES ABRUPT MANEUVERS OR ATTEMPTS TIGHT CONTROL. ADEQUATE PERFORMANCE IS NOT ATTAINABLE AND PILOT MUST REDUCE GAIN TO RECOVER. (PILOT CAN RECOVER BY MERELY REDUCING GAIN)	4
		5
UNSAT	DIVERGENT OSCILLATIONS TEND TO DEVELOP WHEN PILOT INITIATES ABRUPT MANEUVERS OR ATTEMPTS TIGHT CONTROL. PILOT MUST OPEN LOOP BY RELEASING OR FREEZING THE CONTROLLER. DISTURBANCE OR NORMAL PILOT CONTROL MAY CAUSE DIVERGENT OSCILLATION. PILOT MUST OPEN CONTROL LOOP BY RELEASING OR FREEZING THE CONTROLLER.	6

*

SAT = Satisfactory
ADQ = Adequate
CON = Controllable
UNSAT = Unsatisfactory or Failed

this regulation and with sections 4T.115 and 4T.117 for weights, altitudes, temperatures, wind components, and runway gradients, within the operational limits of the airplane (see subparagraph (4) of this paragraph).

(4) *Operational limits.* The operational limits of the airplane shall be established by the applicant for all variable factors required in showing compliance with this regulation (weight, altitude, temperature, etc.). (See secs. 4T.113(a) (1) and (b), 4T.118, 4T.121, and 4T.122.)

(b) *Information.* The performance information on the operation of the airplane shall be scheduled in compliance with the generally applicable provisions of this regulation and with sections 4T.116, 4T.121, and 4T.122 for weights, altitudes, temperatures, wind components, and runway gradients, as these may be applicable, within the operational limits of the airplane (see subparagraph (a)(4) of this section). In addition, the performance information specified in subparagraphs (1) through (3) of this paragraph shall be determined by extrapolation and scheduled for the ranges of weights between the maximum landing and maximum take-off weights established in accordance with subparagraphs (a) (1) and (a) (2) of this section. (See also sec. 4T.743.)

- (1) Climb in the landing configuration (see sec. 4T.119);
- (2) Climb in the approach configuration (see sec. 4T.120(d));
- (3) Landing distance (see sec. 4T.122).

AIRPLANE FLIGHT MANUAL

4T.743 *Performance limitations information, and other data.*

(a) *Limitations.* The airplanes' performance limitations shall be given in accordance with section 4T.123(a).

(b) *Information.* The performance information prescribed in section 4T.123(b) for the application of the operating rules of this regulation shall be given together with descriptions of the conditions, air speeds, etc. under which the data were determined.

(c) *Procedures.* For all stages of flight, procedures shall be given with respect to airplane configurations, power and/or thrust settings, and indicated air speeds, to the extent such procedures are related to the limitations and information set forth in accordance with paragraphs (a) and (b) of this section.

(d) *Miscellaneous.* An explanation shall be given of significant or unusual flight or ground handling characteristics of the airplane.

3. In lieu of sections 40.70 through 40.78, 41-27 through 41.36(d), and 42.70 through 42.83, of Parts 40, 41, and 42 of the Civil Air Regulations, respectively, the following shall be applicable:

OPERATING RULES

40T.80 *Transport category airplane operating limitations.*

(a) In operating any passenger-carrying transport category airplane certificated in accordance with the performance requirements of this regulation, the provisions of sections 40T.80 through 40T.894 shall be complied with, unless deviations therefrom are specifically authorized by the Administrator on the ground that the special circumstances of a particular case make a literal observance of the requirements unnecessary for safety.

(b) The performance data in the Airplane Flight Manual shall be applied in determining compliance with the provisions of sections 40T.81 through 40T.84. Where conditions differ from those for which specific tests were made compliance shall be determined by approved interpolation or computation of the effects of changes in the specific variables if such

- (1) The airplane's center of gravity shall be in the most unfavorable position.
- (2) The critical engine(s) shall be inoperative, the remaining engine(s) operating at the available maximum continuous power and/or thrust.
- (3) Means for controlling the engine cooling air supply shall be in the position which provides adequate cooling in the hot-day condition.
- (4) The speed shall be selected by the applicant.

4T.122 *Landing distance.* The landing distance shall be the horizontal distance required to land and to come to a complete stop (to a speed of approximately 3 knots in the case of seaplanes or float planes) from a point at a height of 50 feet above the landing surface. Landing distances shall be determined for standard temperatures at all weights, altitudes, and winds within the operational limits established by the applicant for the airplane. The conditions of paragraphs (a) through (f) of this section shall apply.

(a) The airplane shall be in the landing configuration. During the landing, changes in the airplane's configuration, in power and/or thrust, and in speed shall be in accordance with procedures established by the applicant for the operation of the airplane in service. The procedures shall comply with the provisions of section 4T.111(c).

(b) The landing shall be preceded by a steady gliding approach down to the 50-foot height with a calibrated air speed of not less than 1.3 V_{SO} .

(c) The landing distance shall be based on a smooth, dry, hard-surfaced runway, and shall be determined in such a manner that reproduction does not require exceptional skill or alertness on the part of the pilot. In the case of seaplanes or float planes, the landing surface shall be smooth water, while for skiplanes it shall be smooth dry snow. During landing, the airplane shall not exhibit excessive vertical acceleration, a tendency to bounce, nose over, ground loop, porpoise, or water loop.

(d) The landing distance shall be corrected for not more than 50 percent of nominal wind components along the landing path opposite to the direction of landing and not less than 150 percent of nominal wind components along the landing path in the direction of landing.

(e) During landing, the operating pressures on the wheel braking system shall not be in excess of those approved by the manufacturer of the brakes, and the wheel brakes shall not be used in such a manner as to produce excessive wear of brakes and tires.

(f) If the Administrator finds that a device on the airplane other than wheel brakes has a noticeable effect on the landing distance and if the device depends upon the operation of the engine and the effect of such a device is not compensated for by other devices in the event of engine failure, the landing distance shall be determined by assuming the critical engine to be inoperative.

4T.123 *Limitations and information.*

(a) *Limitations.* The performance limitations on the operation of the airplane shall be established in accordance with subparagraphs (1) through (4) of this paragraph. (See also sec. 4T.743.)

(1) *Take-off weights.* The maximum take-off weights shall be established at which compliance is shown with the generally applicable provisions of this regulation and with section 4T.120 (a), (b), and (c) for altitudes and ambient temperatures within the operational limits of the airplane (see subparagraph (4) of this paragraph).

(2) *Landing weights.* The maximum landing weights shall be established at which compliance is shown with the generally applicable provisions of this regulation and with sections 4T.119 and 4T.120(d) for altitudes and ambient temperatures within the operational limits of the airplane (see subparagraph (4) of this paragraph).

(3) *Take-off and accelerate-stop distances.* The minimum distances required for takeoff shall be established at which compliance is shown with the generally applicable provisions of

- (iii) The required H_{O_2} rating for A-PC tendencies is shown in Figure 12 of Appendix 7. As described in that appendix, the minimum H_{O_2} rating, and consequently the pass/fail criteria, varies with the flight envelope, atmospheric disturbance considered, and failure state. For example, Figure 20-3 below shows a handling qualities matrix for a tracking task with the airplane at aft c.g. trimmed in flight conditions giving 1.3 g to buffet onset.

FIGURE 20-3

EXAMPLE OF MINIMUM PERMITTED HQ RATING FOR A-PC TENDENCIES

Airplane at aft c.g. trimmed in conditions giving 1.3 g to buffet onset

AIR SPEED LOAD FACTOR RANGE	M _{LRC}	M _{LRC}	M _{LRC}	M _{LRC}
0.8 TO 1.3	0.8 TO 1.3	-1.0 TO 2.5	0.8 TO 1.3	M _{LRC}
ONSET LIGHT	ONSET LIGHT	DETERRENT LIGHT	ONSET LIGHT	-1.0 TO 2.5 DETERRENT LIGHT
FAILURE FLIGHT ENVELOPE	NONE	NONE	IMPROBABLE	IMPROBABLE
MINIMUM PERMITTED HQ RATING	NFE	LFE	NFE	LFE
	SAT	ADQ	ADQ	CON

SAT = Satisfactory ADQ = Adequate CON = Controllable

NFE = Normal flight envelope LFE = Limit flight envelope

SAS = Stability augmentation system

M_{LRC} = Long range cruise mach number

e. Tailplane stall investigation with ice accretion.

(1) Configuration:

(i) All normal combinations of wing flaps and landing gear, except the cruise configuration.

(ii) Critical weight and c.g. for the test wing flap and landing gear position.

(iii) Speeds from 1.2 V_{S0} or V_{Ref-5} kts, as appropriate to the wing flap position, up to the maximum speed to be encountered operationally in a given flap/gear configuration that will not result in exceeding V_{FE} or V_{LEF} as applicable, during the recovery.

(iv) Power or thrust: Flight idle to maximum takeoff.

(v) Icing condition: The applicant should specify the critical ice case(s) to be investigated in terms of location, shape, thickness, and texture. FAA concurrence on the critical ice shape(s) should be obtained prior to testing. The critical ice case(s) should include an allowance for any time delays in activation of the ice protection system associated with ice detection or observation systems, or that may be reasonably expected in service. If ice accretion on the wings can result in increased airflow angle of attack on the horizontal tail, ice shapes will also be required on the wing surface, and should be representative of the ice accumulation that would normally be expected in the icing condition defined to be critical for the tailplane. It should be noted that ice accreted with the flaps retracted may result in a more critical condition than ice accreted with the flaps extended. Ice accretion thickness need not be greater than that resulting from flight in the maximum continuous atmospheric icing conditions defined in Appendix C to Part 25.

(2) **Zero g Pushover Maneuver:** The test procedure described below is essentially a nose down pitching maneuver. Execution of this maneuver should be preceded by experimentation to determine initial entry speeds and pitch attitudes that will result in the airplane achieving the target load factor and airspeed as it pitches through approximately level flight.

20e(1), above.

(i) Trim the airplane in the test configurations and at the test speeds prescribed in paragraph

20e(1), above.

(ii) Initial testing should be conducted by moving the control column forward at a slow rate while evaluating for force lightening or force reversal. Continue the test by incrementally increasing the rate of control movement until a zero g flight condition is obtained or, if limited by elevator power, to the lowest load factor attainable.

WARNING: The test maneuver described above may result in a sudden and violent loss of pitch stability or control due to aerodynamic stall of the horizontal stabilizer and/or elevators. High stick forces may be required to effect recovery; consequently, the non-flying pilot should be prepared to immediately retract the flaps and lend assistance in overcoming any high nose down stick forces.

(iii) A push longitudinal control force must be required throughout the test maneuver.

(iv) The airplane should demonstrate suitable controllability and maneuverability throughout the maneuver with no force reversal and no tendency to diverge in pitch.

(3) **Steady State Sideslip Maneuver:** The following test procedure is intended to determine if the airplane is susceptible to tailplane stall resulting from detached flow on the horizontal tail as induced by a lateral flow component.

(i) For the test conditions described in paragraph 20e(1), establish the airplane in a straight, steady sideslip, up to the sideslip angle appropriate to normal operation of the airplane as used to demonstrate compliance with § 25.177(c).

(ii) Changes in longitudinal control force to maintain speed with increasing sideslip should be progressive with no reversals or sudden discontinuities.

f. **Maneuvering Characteristics - § 25.143(f).**

(1) **General.** An acceptable means of compliance with the requirement that stick forces may not be excessive when maneuvering the airplane is to demonstrate that, in a turn for 0.5g incremental normal acceleration (0.3g above 20,000 feet) at speeds up to V_{Yc}/M_{Yc} , the average stick force gradient does not exceed 120 pounds per g.

(2) **Interpretive Material**

(i) The objective of § 25.143 is to ensure that the limit strength of any critical component on the airplane would not be exceeded in maneuvering flight. In much of the structure, the load sustained in maneuvering flight can be assumed to be directly proportional to the load factor applied. However, this may not be the case for some parts of the structure (e.g., the tail and rear fuselage). Nevertheless, it is accepted that the airplane load factor will be a sufficient guide to the possibility of exceeding limit strength on any critical component if a structural investigation is undertaken whenever the design positive limit maneuvering load factor is closely approached. If flight testing indicates that the positive design limit maneuvering load factor could be exceeded in steady maneuvering flight with a 50 pound stick force, the airplane structure should be evaluated for the anticipated load at a 50 pound stick force. The airplane will be considered to have been overstressed if limit strength has been exceeded in any critical component. For the purposes of this evaluation, limit strength is defined as the lesser of either the limit design loads envelope increased by the available margins of safety, or the ultimate static test strength divided by 1.5.

(ii) Minimum Stick Force to Reach Limit Strength.

(a) **Take-off; landing gear extended.** In the take-off configuration at the point of the flight path where the airplane's speed first reaches V_2 , in accordance with section 4T.116 but without ground effect, the steady gradient of climb shall be positive with:

(1) The critical engine inoperative, the remaining engine(s) operating at the available take-off power and/or thrust existing in accordance with section 4T.116 at the time the airplane's landing gear is fully retracted;

(2) The weight equal to the airplane's weight existing in accordance with section 4T.116 at the time retraction of the airplane's landing gear is initiated;

(3) The speed equal to the speed V_2 .

(b) **Take-off; landing gear retracted.** In the take-off configuration at the point of the flight path where the airplane's landing gear is fully retracted, in accordance with section 4T.116 but without ground effect, the steady gradient of climb shall not be less than 2.5 percent for two-engine airplanes and not less than 3.0 percent for four-engine airplanes, with:

(1) The critical engine inoperative, the remaining engine(s) operating at the take-off power and/or thrust available at a height of 400 feet above the take-off surface and existing in accordance with section 4T.116;

(2) The weight equal to the airplane's weight existing in accordance with section 4T.116 at the time the airplane's landing gear is fully retracted;

(3) The speed equal to the speed V_2 .

(c) **Final take-off.** In the en route configuration, the steady gradient of climb shall not be less than 1.4 percent for two-engine airplanes and not less than 1.8 percent for four-engine airplanes, at the end of the take-off path as determined by section 4T.116, with:

(1) The critical engine inoperative, the remaining engine(s) operating at the available maximum continuous power and/or thrust;

(2) The weight equal to the airplane's weight existing in accordance with section 4T.116 at the time retraction of the airplane's flaps is initiated;

(3) The speed equal to not less than 1.25 V_{Si} .

(d) **Approach.** In the approach configuration such that V_{Si} does not exceed 1.10 V_{So} , the steady gradient of climb shall not be less than 2.2 percent for two-engine airplanes and not less than 2.8 percent for four-engine airplanes, with:

(1) The critical engine inoperative, the remaining engine(s) operating at the available take-off power and/or thrust;

(2) The weight equal to the maximum landing weight;

(3) A climb speed in excess of 1.5 V_{Si}

4T.121 En route flight paths. With the airplane in the en route configuration, the flight paths prescribed in paragraphs (a) and (b) of this section shall be determined at all weights, altitudes, and ambient temperatures within the limits established by the applicant for the airplane.

(a) **One engine inoperative.** The one-engine-inoperative net flight path data shall be determined in such a manner that they represent the airplane's actual climb performance diminished by a gradient of climb equal to 1.4 percent for two-engine airplanes and 1.8 percent for four-engine airplanes. It shall be acceptable to include in these data the variation of the airplane's weight along the flight path to take into account the progressive consumption of fuel and oil by the operating engine(s).

(b) **Two engines inoperative.** For airplanes with four engines, the two-engine-inoperative net flight path data shall be determined in such a manner that they represent the airplane's actual climb performance diminished by a gradient of climb equal to 0.6 percent. It shall be acceptable to include in these data the variation of the airplane's weight along the flight path to take into account the progressive consumption of fuel and oil by the operating engines.

(c) **Conditions.** In determining the flight paths prescribed in paragraphs (a) and (b) of this section, the conditions of subparagraphs (1) through (4) of this paragraph shall apply.

4T.116 *Take-off path.* The take-off path shall be considered to extend from the standing start to a point in the take-off where a height of 1,000 feet above the take-off surface is reached or to a point in the take-off where the transition from the take-off to the en route configuration is completed and a speed is reached at which compliance with section 4T.120(c) is shown, whichever point is at a higher altitude. The conditions of paragraphs (a) through (i) of this section shall apply in determining the take-off path.

(a) The take-off path shall be based upon procedures prescribed in accordance with section 4T.111(c).

(b) The airplane shall be accelerated on or near the ground to the speed V_2 during which time the critical engine shall be made inoperative at speed V_1 and shall remain inoperative during the remainder of the take-off.

(c) Landing gear retraction shall not be initiated prior to reaching the speed V_2

(d) The slope of the airborne portion of the take-off path shall be positive at all points.

(e) After the V_2 speed is reached, the speed throughout the take-off path shall not be less than V_2 and shall be constant from the point where the landing gear is completely retracted until a height of 400 feet above the take-off surface is reached.

(f) Except for gear retraction and propeller feathering, the airplane configuration shall not be changed before reaching a height of 400 feet above the take-off surface.

(g) At all points along the take-off path starting at the point where the airplane first reaches a height of 400 feet above the take-off surface, the available gradient of climb shall not be less than 1.4 percent for two-engine airplanes and 1.8 percent for four-engine airplanes.

(h) The take-off path shall be determined either by a continuous demonstration take-off, or alternatively, by synthesizing from segments the complete take-off path.

(i) If the take-off path is determined by the segmental method, the provisions of subparagraphs (1) through (4) of this paragraph shall be specifically applicable.

(1) The segments of a segmental take-off path shall be clearly defined and shall be related to the distinct changes in the configuration of the airplane, in power and/or thrust, and in speed.

(2) The weight of the airplane, the configuration, and the power and/or thrust shall be constant throughout each segment and shall correspond with the most critical condition prevailing in the particular segment.

(3) The segmental flight path shall be based on the airplane's performance without ground effect

(4) Segmental take-off path data shall be checked by continuous demonstrated take-offs to insure that the segmental path is conservative relative to the continuous path.

4T.117 *Take-off distance.* The take-off distance shall be the horizontal distance along the take-off path from the start of the take-off to the point where the airplane attains a height of 35 feet above the take-off surface as determined in accordance with 4T.116.

4T.118 *Climb; general.* Compliance shall be shown with the climb requirements of sections 4T.119 and 4T.120 at all weights, altitudes, and ambient temperatures, within the operational limits established by the applicant for the airplane. The airplane's center of gravity shall be in the most unfavorable position corresponding with the applicable configuration.

4T.119 *All-engine-operating landing climb.* In the landing configuration, the steady gradient of climb shall not be less than 4.0 per cent, with:

(a) All engines operating at the available take-off power and/or thrust;

(b) A climb speed not in excess of 1.4 V_{SO} .

4T.120 *One-engine-inoperative climb.*

(A) A stick force of at least 50 pounds to reach limit strength in steady maneuver or wind-up turns is considered acceptable to demonstrate adequate minimum force at limit strength in the absence of deterrent buffeting. If heavy buffeting occurs before the limit strength condition is reached, a somewhat lower stick force at limit strength may be acceptable. The acceptability of a stick force of less than 50 pounds at the limit strength condition will depend upon the intensity of the buffet, the adequacy of the warning margin (i.e., the load factor increment between the heavy buffet and the limit strength condition), and the stick force characteristics. In determining the limit strength condition for each critical component, the contribution of buffet loads to the overall maneuvering loads should be taken into account.

(B) This minimum stick force applies in the enroute configuration with the airplane trimmed for straight flight, at all speeds above the minimum speed at which the limit strength condition can be achieved without stalling. No minimum stick force is specified for other configurations, but the requirements of § 25.143(f) are applicable in these conditions.

(iii) Stick Force Characteristics.

(A) At all points within the buffet onset boundary determined in accordance with § 25.251(e), but not including speeds above V_{FC}/M_{FC} , the stick force should increase progressively with increasing load factor. Any reduction in stick force gradient with change of load factor should not be so large or abrupt as to impair significantly the ability of the pilot to maintain control over the load factor and pitch attitude of the airplane.

(B) Beyond the buffet onset boundary, hazardous stick force characteristics should not be encountered within the permitted maneuvering envelope as limited by paragraph 20e(2)(iii)(C). It should be possible, by use of the primary longitudinal control alone, to rapidly pitch the airplane nose down so as to regain the initial trimmed conditions. The stick force characteristics demonstrated should comply with the following:

(1) For normal acceleration increments of up to 0.3g beyond buffet onset, where these can be achieved, local reversal of the stick force gradient may be acceptable, provided that any tendency to pitch up is mild and easily controllable.

(2) For normal acceleration increments of more than 0.3g beyond buffet onset, where these can be achieved, more marked reversals of the stick force gradient may be acceptable. It should be possible to contain any pitch-up tendency of the airplane within the allowable maneuvering limits, without applying push forces to the control column and without making a large and rapid forward movement of the control column.

(C) In flight tests to satisfy paragraphs 20f(2)(iii)(A) and (B), the load factor should be increased until either:

(1) The level of buffet becomes sufficient to provide a strong and effective deterrent to any further increase of the load factor; or

(2) Further increase of the load factor requires a stick force in excess of 150 pounds (or in excess of 100 pounds when beyond the buffet onset boundary) or is impossible because of the limitations of the control system; or

(3) The positive limit maneuvering load factor established in compliance with § 25.337(b) is achieved.

(iv) Negative Load Factors. It is not intended that a detailed flight test assessment of the maneuvering characteristics under negative load factors should necessarily be made throughout the specified range of conditions. An assessment of the characteristics in the normal flight envelope involving normal accelerations from 1g to zero g will normally be sufficient. Stick forces should also be assessed during other required flight testing involving negative load factors. Where these assessments reveal stick force gradients that are unusually low, or that are subject to significant variation, a more detailed assessment, in the most critical of the specified conditions, will be required. This may be based on calculations, provided they are supported by adequate flight test or wind tunnel data.

21. LONGITUDINAL CONTROL - § 25.145

a. Explanation.

(1) Section 25.145(a) requires that there be adequate longitudinal control to promptly pitch the airplane nose down from an, or near the stall to return to the original trim speed. The intent is to insure sufficient pitch control if inadvertently slowed to the point of stall. Though § 25.145(a)(4) requires testing at power settings between idle and maximum continuous, it is not intended that airplanes should be taken to the point of stall with high power settings; this situation is addressed by basing the minimum test speed on stall warning plus a pilot recognition time, as described in paragraph 21(b)(1)(ii).

* (2) Section 25.145(b) requires changes to be made in flap position, power, and speed without undue effort when rettrimming is impractical. The purpose is to ensure that any of these changes are possible assuming that the pilot finds it necessary to devote at least one hand to the initiation of the desired operation without being overpowered by the primary airplane controls. The objective is to show that an excessive change in trim does not result from the application or removal of power or the extension or retraction of wing flaps. The presence of gated positions on the flap control does not affect the requirement to demonstrate full flap extensions and retractions without changing the trim control. Compliance with § 25.145(b) also requires that the relation of control force to speed be such that reasonable changes in speed may be made without encountering very high control forces.

(3) Section 25.145(c) contains requirements associated primarily with attempting a go-around maneuver from the landing configuration. Retraction of the high-lift devices from the landing configuration should not result in a loss of altitude if the power or thrust controls are moved to the go-around setting at the same time that flap/stair retraction is begun. The design features involved with this requirement are the rate of flap/stair retraction, the presence of any flap gates, and the go-around power or thrust setting. The go-around power or thrust setting should be the same as is used to comply with the approach and landing climb performance requirements of §§ 25.121(d) and 25.119, and the controllability requirements of §§ 25.145(b)(3), 25.145(b)(4), 25.145(b)(5), 25.149(f), and 25.149(g). The controllability requirements may limit the go-around power or thrust setting.

* (4) Section 25.145(d) provides requirements for demonstrating compliance with § 25.145(c) when gates are installed on the flap selector. Section 25.145(d) also specifies gate design requirements. Flap gates, which prevent the pilot from moving the flap selector through the gated position without a separate and distinct movement of the selector, allow compliance with these requirements to be demonstrated in segments. High lift device retraction must be demonstrated beginning from the maximum landing position to the first gated position, between gated positions, and from the last gated position to the fully retracted position.

(i) If gates are provided, § 25.145(d) requires the first gate from the maximum landing position to be located at a position corresponding to a go-around configuration. If there are multiple go-around configurations, the following criteria should be considered when selecting the location of the gate:

- (A) The expected relative frequency of use of the available go-around configurations.
- (B) The effects of selecting the incorrect high-lift device control position.

(C) The potential for the pilot to select the incorrect control position, considering the likely situations for use of the different go-around positions.

(D) The extent to which the gate(s) aid the pilot in quickly and accurately selecting the correct position of the high-lift devices.

(ii) Regardless of the location of any gates, initiating a go-around from any of the approved landing positions should not result in a loss of altitude. Therefore, § 25.145(d) requires that compliance with § 25.145(c) be demonstrated for retraction of the high-lift devices from each approved landing position to the control position(s) associated with the high-lift device configuration(s) used to establish the go-around procedure(s) from that landing position. A separate demonstration of compliance with this requirement should only be necessary if there is a gate between an approved landing position and its associated go-around position(s). If there is more than one associated

4T.113 *Take-off: general*

(a) The take-off data in sections 4T.114 through 4T.117 shall be determined under the conditions of subparagraphs (1) and (2) of this paragraph.

(1) At all weights, altitudes, and ambient temperatures within the operational limits established by the applicant for the airplane.

(2) In the configuration for take-off (see sec. 4T.111).

(b) Take-off data shall be based on a smooth, dry, hard-surfaced runway, and shall be determined in such a manner that reproduction of the performance does not require exceptional skill or alertness on the part of the pilot. In the case of seaplanes or float planes, the take-off surface shall be smooth water, while for skiplanes it shall be smooth dry snow. In addition, the take-off data shall be corrected in accordance with subparagraphs (1) and (2) of this paragraph for wind and for runway gradients within the operational limits established by the applicant for the airplane.

(1) Not more than 50 percent of nominal wind components along the take-off path opposite to the direction of take-off, and not less than 150 percent of nominal wind components along the take-off path in the direction of take-off.

(2) Effective runway gradients.

4T.114 *Take-off speeds.*

(a) The critical-engine-failure speed V_1 , in terms of calibrated air speed, shall be selected by the applicant, but shall not be less than the minimum speed at which controllability by primary aerodynamic controls alone is demonstrated during the take-off run to be adequate to permit proceeding safely with the take-off using average piloting skill, when the critical engine is suddenly made inoperative.

(b) The minimum take-off safety speed V_2 , in terms of calibrated air speed, shall be selected by the applicant so as to permit the gradient of climb required in section 4T.120 (a) and (b), but it shall not be less than:

(1) $1.2 V_{SI}$ for two-engine propeller-driven airplanes and for airplanes without propellers which have no provisions for obtaining a significant reduction in the one-engine-inoperative power-on stalling speed.

(2) $1.15 V_{SI}$ for propeller-driven airplanes having more than two engines and for airplanes without propellers which have provisions for obtaining a significant reduction in the one-engine-inoperative power-on stalling speed.

(3) 1.10 times the minimum control speed V_{MC} , established in accordance with section 4b.133 of Part 4b of the Civil Air Regulations.

(c) If engine failure is assumed to occur at or after the attainment of V_2 , the demonstration in which the take-off run is continued to include the take-off climb, as provided in paragraph (a) of this section, shall not be required.

4T.115 *Accelerate-stop distance.*

(a) The accelerate-stop distance shall be the sum of the following:

(1) The distance required to accelerate the airplane from a standing start to the speed V_1 ;

(2) Assuming the critical engine to fail at the speed V_1 , the distance required to bring the airplane to a full stop from the point corresponding with the speed V_1 .

(b) In addition to, or in lieu of, wheel brakes, the use of other braking means shall be acceptable in determining the accelerate-stop distance, provided that such braking means shall have been proven to be safe and reliable, that the manner of their employment is such that consistent results can be expected in service, and that exceptional skill is not required to control the airplane.

(c) The landing gear shall remain extended throughout the accelerate-stop distance.

(2) If applicable, propeller pitch controls in the position necessary for compliance with subparagraph (1) of this paragraph; the airplane in all other respects (flaps, landing gear, etc.) in the particular configuration corresponding with that in connection with which V_{SI} is being used;

(3) The weight of the airplane equal to the weight in connection with which V_{SI} is being used to determine compliance with a particular requirement.

(c) The stall speeds defined in this section shall be the minimum speeds obtained in flight tests conducted in accordance with the procedure of subparagraphs (1) and (2) of this paragraph.

(1) With the airplane trimmed for straight flight at a speed of $1.4 V_S$ and from a speed sufficiently above the stalling speed to insure steady conditions, the elevator control shall be applied at a rate such that the airplane speed reduction does not exceed one knot per second.

(2) During the test prescribed in subparagraph (1) of this paragraph, the flight characteristics provisions of section 4b.160 of Part 4b of the Civil Air Regulations shall be complied with.

go-around position, conducting this test using the go-around configuration with the most retracted high-lift device position should suffice, unless there is a more critical case. If there are no gates between any of the landing flap positions and their associated go-around positions, the demonstrations discussed in paragraph 2(a)(4) above should be sufficient to show compliance with this provision of § 25.145(d).

b. Procedures. The following test procedures outline an acceptable means for demonstrating compliance with § 25.145. These tests may be conducted at an optional altitude in accordance with § 25.21(c). Where applicable, the conditions should be maintained on the engines throughout the maneuver.

(1) Longitudinal control recovery, § 25.145(a):

(i) Configuration:

(A) Maximum weight or a lighter weight if considered more critical.

(B) Aft c.g. position.

(C) Landing gear extended.

(D) Wing flaps retracted and extended to the maximum landing position.

(E) Engine power at idle and maximum continuous.

(ii) Test procedure: The airplane should be trimmed at the speed for each configuration as prescribed in § 25.103(b)(1). The airplane should then be decelerated at 1 knot per second with wings level. For tests at idle power, it should be demonstrated that the nose can be pitched down from any speed between the trim speed and the stall. Typically, the most critical point is at the stall when in stall buffet. The rate of speed increase during the recovery should be adequate to promptly return to the trim point. Data from the stall characteristics testing can be used to evaluate this capability at the stall. For tests at maximum continuous power, the maneuver need not be continued for more than one second beyond the onset of stall warning. However, the static longitudinal stability characteristics during the maneuver, and the nose down control power remaining at the end of the maneuver, must be sufficient to assure that a prompt recovery to the trim speed could be attained if the airplane is slowed to the point of stall.

(2) Longitudinal control, flap extension, § 25.145(b)(1).

(i) Configuration:

(A) Maximum landing weight or a lighter weight if considered more critical.

(B) Critical c.g. position.

(C) Wing flaps retracted.

(D) Landing gear extended.

(E) Engine power at flight idle.

(ii) Test procedure: The airplane should be trimmed at a speed of $1.4V_S$. The flaps should be extended to the maximum landing position as rapidly as possible while maintaining approximately $1.4V_S$ for the flap position existing at each instant throughout the maneuver. The control forces should not exceed 50 lbs. (the maximum force for short term application that can be applied readily by one hand) throughout the maneuver without changing the trim control.

(3) Longitudinal control, flap retraction, §§ 25.145(b)(2) & (3).

(i) Configuration:

- (A) Maximum landing weight or a lighter weight if considered more critical.
- (B) Critical c.g. position.
- (C) Wing flaps extended to maximum landing position.
- (D) Landing gear extended.
- (E) Engine power at flight idle and the go-around power or thrust setting.
- (ii) Test procedure: With the airplane trimmed at $1.4V_S$, the flaps should be retracted to the full up position while maintaining approximately $1.4V_S$ for the flap position existing at each instant throughout the maneuver. The longitudinal control force should not exceed 50 lbs. throughout the maneuver without changing the trim control.

(4) Longitudinal control, power application, §§ 25.145(b)(4) & (5)

(i) Configuration:

- (A) Maximum landing weight or a lighter weight if considered more critical.
- (B) Critical c.g. position.
- (C) Wing flaps retracted and extended to the maximum landing position.
- (D) Landing gear extended.
- (E) Engine power at flight idle.
- (ii) Test procedure: The airplane should be trimmed at a speed of $1.4V_S$. Quickly set go-around power or thrust while maintaining the speed of $1.4V_S$. The longitudinal control force should not exceed 50 pounds throughout the maneuver without changing the trim control.

(5) Longitudinal control, airspeed variation, § 25.145(b)(6).

(i) Configuration:

- (A) Maximum landing weight or a lighter weight if considered more critical.
- (B) Most forward c.g. position.
- (C) Wing flaps extended to the maximum landing position.
- (D) Landing gear extended.
- (E) Engine power at flight idle.
- (ii) Test Procedure: The airplane should be trimmed at a speed of $1.4V_S$. The speed should then be reduced to $1.1V_S$ and then increased to $1.7V_S$, or the flap placard speed, V_{F2} , whichever is lower. The longitudinal control force should not be greater than 50 lbs. Data from the static longitudinal stability tests in the landing configuration at forward c.g., § 25.175(d), may be used to show compliance with this requirement.

(6) Longitudinal control, flap retraction and power application, § 25.145(c).

(i) Configuration:

- (A) Critical combinations of maximum landing weights and altitudes.

(b) Unless otherwise specifically prescribed, the performance shall correspond with ambient atmospheric conditions and still air. Humidity shall be accounted for as specified in paragraph (c) of this section.

(c) The performance as affected by engine power and/or thrust shall be based on a relative humidity of 80 percent at and below standard temperatures and on 34 percent at and above standard temperatures plus 50°F. Between these two temperatures the relative humidity shall vary linearly.

(d) The performance shall correspond with the propulsive thrust available under the particular ambient atmospheric conditions, the particular flight conditions, and the relative humidity specified in paragraph (c) of this section. The available propulsive thrust shall correspond with engine power and/or thrust not exceeding the approved power and/or thrust less the installation losses and less the power and/or equivalent thrust absorbed by the accessories and services appropriate to the particular ambient atmospheric conditions and the particular flight condition.

4T.111 *Airplane configuration, speed, power, and/or thrust; general.*

(a) The airplane configuration (setting of wing and cowl flaps, air brakes, landing gear, propeller, etc.), denoted respectively as the take-off, en route, approach, and landing configurations, shall be selected by the applicant except as otherwise prescribed.

(b) It shall be acceptable to make the airplane configurations variable with weight, altitude, and temperature, to an extent found by the Administrator to be compatible with operating procedures required in accordance with paragraph (c) of this section.

(c) In determining the accelerate-stop distances, take-off flight paths, take-off distances, and landing distances, changes in the airplane's configuration and speed, and in the power and/or thrust shall be in accordance with procedures established by the applicant for the operation of the airplane in service, except as otherwise prescribed. The procedures shall comply with the provisions of subparagraphs (1) through (3) of this paragraph.

- (1) The Administrator shall find that the procedures can be consistently executed in service by crews of average skill.
- (2) The procedures shall not involve methods or the use of devices which have not been proven to be safe and reliable.
- (3) Allowance shall be made for such time delays in the execution of the procedures as may be reasonably expected to occur during service.

4T.112 *Stalling speeds.*

The minimum steady flight speed at which the airplane is controllable, in

(a) The speed V_{S0} shall denote the calibrated stalling speed, or knots, with:

- (1) Zero thrust at the stalling speed, or engines idling and throttles closed if it is shown that the resultant thrust has no appreciable effect on the stalling speed;

(2) If applicable, propeller pitch controls in the position necessary for compliance with subparagraph (1) of this paragraph;

- (3) The airplane in the landing configuration;
- (4) The center of gravity in the most unfavorable position within the allowable landing range;

(5) The weight of the airplane equal to the weight in connection with which V_S is being used to determine compliance with a particular requirement.

(b) The speed V_{SI} shall denote the calibrated stalling speed, or the minimum steady flight speed at which the airplane is controllable, in knots, with:

- (1) Zero thrust at the stalling speed, or engines idling and throttles closed if it is shown that the resultant thrust has no appreciable effect on the stalling speed;

such as altitude, temperature, and wind. Since these limitations are in the airworthiness certificate, they are applicable to all type operations conducted with the airplane.

The new performance code contains values for minimum climb expressed as gradients of climb, in percent, rather than as rates of climb, in feet per minute, as has been the case heretofore. The Board believes that the gradient of climb is more direct in expressing the performance margins of the airplane. Use of the gradient eliminates the influence of the stalling speed on the required climb. Heretofore, higher rates of climb were required for airplanes with higher stalling speeds. The only differentiation in the new code with respect to the required climb is between two and four-engine airplanes. This type of differentiation is of long standing in the regulations, being applicable to the one-engine-inoperative stage of flight. It is now being expanded to the take-off and approach stages.

The new performance requirements contained herein are based on the best information presently available to the Board. It is realized, however, that due to the present limited operating experience with turbine-powered transport airplanes, improvement in the requirements can be expected as a result of the direct application of the code to specific designs of new airplanes. There are certain areas in the new requirements where additional refinement of details might be advisable. This is so particularly in the case of the requirements pertaining to the landing stage of flight. It is anticipated that, after further study of the regulation and especially after its application in the design, certification, and operation of forthcoming turbine-powered airplanes, the desirability of changes may become more apparent. It is the intent of the Board to consider without delay such changes as might be found necessary. Only after the provisions of this Special Civil Air Regulation are reasonably verified by practical application will the Board consider incorporating them on a more permanent basis into Parts 4b, 40, 41, and 42 of the Civil Air Regulations.

This Special Civil Air Regulation is not intended to compromise the authority of the Administrator under section 4b.10 to impose such special conditions as he finds necessary in any particular case to avoid unsafe design features and otherwise to insure equivalent safety.

Interested persons have been afforded an opportunity to participate in the making of this regulation (21 F.R. 6091), and due consideration has been given to all relevant matter presented. In consideration of the foregoing, the Civil Aeronautics Board hereby makes and promulgates the following Special Civil Air Regulation, effective August 27, 1957.

Contrary provisions of the Civil Air Regulations notwithstanding, all turbine-powered transport category airplanes for which a type certificate is issued after the effective date of this Special Civil Air Regulation shall comply with the following:

1. The provisions of Part 4b of the Civil Air Regulations, effective on the date of application for type certificate; and such of the provisions of all subsequent amendments to Part 4b, in effect prior to the effective date of this special regulation, as the Administrator finds necessary to insure that the level of safety of turbine-powered airplanes is equivalent to that generally intended by Part 4b.

2. In lieu of sections 4b.110 through 4b.125, and 4b.743 of Part 4b of the Civil Air Regulations, the following shall be applicable:

PERFORMANCE

4T.110 General.

(a) The performance of the airplane shall be determined and scheduled in accordance with, and shall meet the minima prescribed by, the provisions of sections 4T.110 through 4T.123. The performance limitations, information, and other data shall be given in accordance with section 4T.743.

(B) Critical c.g. position.

(C) Wing flaps extended to the maximum landing position and gated position, if applicable.

(D) Landing gear extended.

(E) Engine power for level flight at a speed of 1.1V_S for propeller driven airplanes, or 1.2V_S for turbojet powered airplanes.

(ii) Test procedure. With the airplane stable in level flight at a speed of 1.1V_S for propeller driven airplanes, or 1.2V_S for turbojet powered airplanes, retract the flaps to the full up position, or the next gated position, while simultaneously setting go-around power or thrust. Use the same power or thrust as is used to comply with the performance requirement of § 25.121(d), as limited by the applicable controllability requirements. It must be possible, without requiring exceptional piloting skill, to prevent losing altitude during the maneuver. Trimming is permissible at any time during the maneuver. If gates are provided, conduct this test beginning from the maximum landing flap position to the first gate, from gate to gate, and from the last gate to the fully retracted position. If there is a gate between any landing position and its associated go-around position(s), this test should also be conducted from that landing position through the gate to the associated go-around position. If there is more than one associated go-around position, this additional test should be conducted using the go-around position corresponding to the most retracted flap position, unless another position is more critical. Keep the landing gear extended throughout the test.

(7) Longitudinal control, extreme out-of-trim takeoff conditions, §§ 25.107(e)(4) and 25.143(a)(1).

(i) Configuration:

(A) Critical combinations of takeoff weight and forward and aft c.g. limits.

(B) Wing flaps in all takeoff positions.

(C) All engines operating at maximum takeoff power or thrust.

(ii) The airplane should be loaded to weight and c.g. combinations representing critical corners of the takeoff envelope for both forward and aft c.g. limits. The longitudinal trim should be set for the extreme opposite c.g. (e.g., load to forward c.g. limit at a given weight and set the longitudinal trim for the aft c.g. limit at that weight) as presented in the takeoff trim "green-band" including the takeoff warning system rigging tolerance. Accomplish a takeoff at normal operating speeds and evaluate the control forces and airplane responses to control inputs. In accordance with § 25.107(e)(4), this out-of-trim takeoff configuration must not result in any unsafe flight characteristics.

22. DIRECTIONAL AND LATERAL CONTROL - § 25.147.

a. Explanation.

(1) Sections 25.147(a) and (b) provide criteria for investigation of the airplane to determine if it may have dangerous characteristics such as rudder lock or loss of directional control if it is maneuvered with the rudder only, maintaining wings level, when one or two critical engines are inoperative. Some yaw should be possible into the operating engine(s). It should also be possible to make reasonably sudden heading changes of up to 15 degrees, as limited by rudder force or deflection, toward the inoperative engine(s). The intention of the requirement is that the airplane can be yawed as prescribed without the need for application of bank angle. Small variations of bank angle that are inevitable in a realistic flight test demonstration are acceptable.

(2) Sections 25.147(c) and (d) require an airplane to be easily controllable with the critical engine(s) inoperative. Roll response, § 25.147(e), should be satisfactory for takeoff, approach, landing, and high speed configurations. Any permissible configuration that could affect roll response should be evaluated.

b. Procedures.

- (1) Directional Control - General, § 25.147(a)
- (i) Configuration:
- (A) Maximum landing weight.
 - (B) Most aft c.g. position.
 - (C) Wing flaps extended to the approach position.
 - (D) Landing gear retracted.
 - (E) Yaw SAS on, and off if applicable.
 - (F) Operating engine(s) at the power for level flight at 1.4V_S, but not more than maximum continuous power.
 - (G) Inoperative engine that would be most critical for controllability, with propeller feathered, if applicable.
- (ii) Test Procedure. The airplane should be trimmed in level flight at the most critical altitude in accordance with § 25.211(c). Reasonably sudden changes in heading to the left and right, using ailerons to maintain approximately wings level flight, should be made demonstrating a change of up to 15 degrees or that at which 150 lbs. rudder force is required. The airplane should be controllable and free from any hazardous characteristics during this maneuver. For the airplane equipped with a rudder boost system, the evaluation should be done without rudder boost if the boost system can be inoperative.
- (2) Directional Control - Four or More Engines, § 25.147(b).
- (i) Configuration:
- (A) Maximum landing weight.
 - (B) Most forward c.g. position.
 - (C) Wing flaps in the most favorable climb position (normally retracted).
 - (D) Landing gear retracted.
 - (E) Yaw SAS on, and off if applicable.
 - (F) Operating engines at the power required for level flight at 1.4V_{S1}, but not more than maximum continuous power.
 - (G) Two inoperative engines that would be most critical for controllability with (if applicable) propellers feathered.
- (ii) Test Procedure. The procedure outlined in subparagraph 22b(1)(ii), above, is applicable to this test.
- (3) Lateral Control - General, § 25.147(c).
- (i) Configuration:
- (A) Maximum takeoff weight.
 - (B) Most aft c.g. position.

A significant change being made is the introduction of full temperature accountability in all stages of performance, except the landing distances required. The introduction of full temperature accountability will insure that the airplane's performance is satisfactory irrespective of the existing atmospheric temperature. The performance requirements heretofore applicable did not give sufficient assurance in this respect.

The reason for omitting the direct application of temperature accountability in the requirement for landing distances is that this stage of performance always has been treated in a highly empirical fashion whereby temperature effects are taken into account indirectly together with the effects of other operational factors. Long range studies on rationalization of airplane performance so far have not yielded a satisfactory solution to the landing stage of performance. The Board hopes, however, that continued studies will result in a solution of this problem in the near future.

The introduction of full temperature accountability has necessitated a complete re-evaluation of the minimum climb requirements. Since the prescribed climb must now be met at all temperatures rather than to be associated with standard temperature, the specific values of climb have been altered. In each instance, the change has been in the downward direction because, although the previous values were related to standard temperature, a satisfactory resultant climb performance was attained at temperatures substantially above standard. While values of minimum climb performance specified in the new code will tend to increase the maximum certificated weights of the airplane for the lower range of temperatures, they will limit these weights for the upper range of temperatures, giving adequate assurance of satisfactory climb performance at all temperatures.

In considering the various stages of flight where minimum values of climb have been heretofore established, the Board finds that in two of the stages (all-engines-operating en route and one-engine-inoperative en route) the establishment of minimum values of climb is unnecessary because, in the case of the all-engines-operating stage, it has been found not to be critical and the case of the one-engine-inoperative stage is now more effectively covered by the en route performance operating limitations.

Considering that the minimum climbs being prescribed affect mainly the maximum certificated weights of the airplane but not the maximum operating weights, the Board, in adopting the new performance code, places considerable emphasis on the ability of the airplane to clear obstacles on take-off and during flight. To this end, criteria for the take-off path, the en route flight paths, and the transition from take-off to the en route stage of flight have been prescribed to reflect realistic operating procedures. Temperature is fully accounted for in establishing all flight paths and an expanding clearance between the take-off path and the terrain or obstacles is required until the en route stage of flight is reached.

In order to insure that the objectives of the prescribed performance are in fact realized in actual operations, the manufacturer is required to establish procedures to be followed in the operation of the airplane in the various conditions specified in the regulation. These procedures, each designed for a specific airplane, will permit the operator to utilize the full performance capabilities of the airplane more readily than if the regulations prescribed all-inclusive procedures. The use of these procedures in determining compliance with the requirements governing take-off, en route, and landing stages, will also add considerable flexibility to the regulation.

The new performance requirements established more clearly than heretofore which of the performance limitations are conditions on the airworthiness certificate of the airplane. In addition to the maximum certificated take-off and landing weights, there are included limitations on the take-off distances and on the use of the airplane within the ranges of operational variables,

SPECIAL CIVIL AIR REGULATION NO. SR-422

Effective: August 27, 1957
Adopted: July 23, 1957

Turbine-Powered Transport Category Airplanes of Current Design

Part 4b of the Civil Air Regulations contains rules governing the design of transport category airplanes. For a number of years, this part has established airworthiness requirements for this category of airplanes by prescribing detailed provisions to be met for the issuance of a type certificate. However, the advent of turbine-powered airplanes (jets, turbo-props, etc.) has brought about operations at considerably higher speeds and altitudes than those involving reciprocating engine airplanes. These higher speeds and altitudes as well as certain inherent characteristics of turbine engines have introduced numerous new technical and design problems and have necessitated re-evaluation and amendment of many provisions in Part 4b.

In recent years the Board has amended Part 4b by introducing numerous technical provisions more specifically applicable to turbine-powered airplanes. These were included in amendments pertaining to structural, flight characteristic, powerplant installation, and other provisions. It is believed that Part 4b as now written is applicable to turbine-powered airplanes with but one exception; namely, airplane performance. In the future, further amendments to this part, other than those relating to performance, will be comparatively minor in nature mainly reflecting the latest experience in the certification and operation of these airplanes.

The performance requirements presently in Part 4b were first promulgated almost twelve years ago. They are now considered by the Board to be in a form not suitable for direct application to turbine-powered airplanes.

The administrator of Civil Aeronautics is in receipt of a large number of applications for type certification of turbine-powered airplanes. However, the so-called "non-retroactive" clause of section 4b.11(a) of Part 4b does not make applicable to a particular airplane type any amendment which is adopted after an application is filed by the manufacturer for type certification of that airplane. Thus, most of these airplanes are not now required to meet some of the latest effective provisions of Part 4b unless the Board prescribes otherwise. With so many applications for type certificates pending, it is essential that the Board establish adequate requirements which will effectively apply to the type certification of turbine-powered transport category airplanes. This Special Civil Air Regulation is being promulgated for that purpose.

This Special Civil Air Regulation is being made effective with respect to all turbine-powered transport category airplanes not yet certificated. In essence, it prescribes a revised set of performance requirements for turbine-powered airplanes and incorporates such of the recent amendments to Part 4b as the Administrator finds necessary to insure that the level of safety of turbine-powered airplanes is equivalent to that generally intended by Part 4b.

The performance requirements contained herein include not only the performance requirements necessary for the certification of an airplane, but also the complementary performance operating limitations as applicable under Parts 40, 41, and 42 of the Civil Air Regulations. In promulgating this new performance code, the Board intends that the resulting level of safety will be generally similar to the level of safety established by the performance code as expressed by the provisions now contained in Parts 4b and 40 (or 41 or 42 as appropriate) for reciprocating engine airplanes. To attain this, many of the performance provisions have been modified for better applicability to turbine-powered airplanes, some in the direction of liberalization, others in the direction of improvement in the required performance.

- (C) Wing flaps in the most favorable climb position.
- (D) Landing gear retracted and extended.
- (E) Yaw SAS on, and off if applicable.
- (F) Operating engine(s) at maximum continuous power.
- (G) The inoperative engine that would be most critical for controllability, with the propeller feathered, if applicable.

(ii) Test Procedure. With the airplane trimmed at $1.4V_{S_0}$, turns with a bank angle of 20 degrees should be demonstrated with and against the inoperative engine from a steady climb at $1.4V_{S_1}$. It should not take exceptional piloting skill to make smooth, predictable turns.

(4) Lateral Control - Four or More Engines, § 25.147(d).

(i) Configuration:

- (A) Maximum takeoff weight.
- (B) Most aft c.g. position.
- (C) Wing flaps in the most favorable climb position.
- (D) Landing gear retracted and extended.
- (E) Yaw SAS on, and off if applicable.
- (F) Operating engines at maximum continuous power.
- (G) Two inoperative engines most critical for controllability, with propellers feathered, if applicable.

(ii) Test Procedure: The procedure outlined in paragraph 22b(3)(ii) is applicable to this test.

(5) Lateral Control - All Engines Operating, § 25.147(e).

- (i) Configuration: All configurations within the flight envelope for normal operation.
- (ii) Test Procedure: This is primarily a qualitative evaluation that should be conducted throughout the test program. Roll performance should be investigated throughout the flight envelope, including speeds to V_{FC}/M_{FC} to ensure adequate peak roll rates for safety, considering the flight condition, without excessive control force or travel. Roll response during sideslips expected in service should provide maneuvering capabilities adequate to recover from such conditions. Approach and landing configurations should be carefully evaluated to ensure adequate control to compensate for gusts and wake turbulence while in close proximity to the ground.

23. MINIMUM CONTROL SPEED - § 25.149.

a. Explanation. Section 25.149 defines requirements for minimum control speeds during takeoff climb (V_{MCO}), during takeoff ground roll (V_{MCGO}), and during approach and landing (V_{MCL} and V_{MCL-2}). The V_{MCO} (commonly referred to as V_{MCA}) requirements are specified in §§ 25.149(a), (b), (c) and (d); the V_{MCGO} requirements are described in § 25.149(e); and the V_{MCL} and V_{MCL-2} requirements are covered in §§ 25.149(f), (g) and (h). Section 25.149(a) states that "...the method used to simulate critical engine failure must represent the most critical mode of powerplant failure with respect to controllability expected in service." That is, the thrust loss from the inoperative engine must be at the rate that would occur if an engine suddenly became inoperative in service.

Prior to Amendment 25-42 to § 25.149, the regulation required that rudder control forces must not exceed 180 lbs. With the adoption of Amendment 25-42, rudder control forces became limited to 150 lbs. The relationships between V_{er} , V_1 , and V_{MCG} are discussed in paragraph 10, Takeoff and Takeoff Speeds, and paragraph 11, Accelerate-Stop Distance.

b. Procedures.

(1) General.

(i) Prior to beginning the minimum control speed tests, an evaluation should be conducted to determine which engine's failure will result in the largest asymmetric yawing moment (i.e., the "critical" engine). This is typically done by setting one outboard engine to maximum thrust, setting the corresponding opposite engine at idle, and decelerating with wings level until full rudder is required. By alternating power on/power off from left to right, the critical engine can be defined as the idle engine that requires the highest minimum speed to maintain a constant heading with full rudder deflection.

(ii) For propeller-driven airplanes, V_{MCA} , V_{MCG} , and V_{MCL} (and V_{MCL-2} , as applicable) should be determined by rendering the critical engine(s) inoperative and allowing the propeller to attain the position it automatically assumes. However, for some engine/propeller installations, a more critical drag condition could be produced as the result of a failure mode that results in a partial power condition that does not actuate the automatic propeller drag reduction system (e.g., autofeather system). One example is a turbopropeller installation that can have a fuel control failure, which causes the engine to go to flight idle, resulting in a higher asymmetric yawing moment than would result from an inoperative engine. In such cases, the minimum control speed tests must be conducted using the most critical failure mode. For propeller-driven airplanes where V_{MCA} is based on operation of a propeller drag reduction system, V_{MCA} should also be defined with the critical engine at idle to address the training situation where engine failure is simulated by retarding the critical engine to idle. If V_{MCA} at idle is more than one knot greater than for the engine failure with an operating drag reduction system, the idle engine V_{MCA} should be included in the Normal Procedures section of the Airplane Flight Manual (AFM) as advisory information to maintain the level of safety in the aforementioned training situation.

(iii) Airplane Flight Manual values of V_{MCA} , V_{MCG} , and V_{MCL} (and V_{MCL-2} , as applicable) should be based on the maximum net thrust reasonably expected for a production engine. These speeds should not be based on specification thrust, since this value represents the minimum thrust guaranteed by the engine manufacturer, and the resulting minimum control speeds will not be representative of what could be achieved in operation. The maximum thrust used for scheduled AFM minimum control speeds should represent the high side of the tolerance band, but may be determined by analysis instead of tests.

(iv) When determining V_{MCA} , V_{MCL} , and V_{MCL-2} , consideration should be given to the adverse effect of maximum approved lateral fuel imbalance on lateral control availability. This is especially of concern if tests or analysis show that the lateral control available is the determining factor of a particular V_{MCG} .

(2) Minimum Control Speeds - Air (V_{MCA}).

(i) To comply with the V_{MCA} requirements, the following two conditions must be satisfied:
(Separate tests are usually conducted to show compliance with these two requirements.)

(A) The stabilized (static) condition where constant heading is maintained without exceeding a 5-degree bank angle, and

(B) The dynamic condition in which control is maintained without exceeding a heading change of 20 degrees.

(ii) Static Test Procedure and Required Data.

(A) To determine V_{MCA} , use the configuration specified in § 25.149, except that V_{MCA} is normally determined at minimum weight in order to minimize the stall speed and because static V_{MCA} decreases

APPENDIX I

HISTORY OF JET TRANSPORT PERFORMANCE STANDARDS

When the first jet transport airplanes were certificated in the late 1950s, the applicable transport category airworthiness regulations were contained in Part 4b of the Civil Air Regulations (CAR 4b). The airworthiness requirements of CAR 4b were developed from years of experience with propeller-driven airplanes powered by reciprocating engines. The different powerplant operating principles, and expanded speed and altitude envelopes of the first generation jet-powered airplanes required comprehensive changes to the performance requirements of CAR 4b. Special Civil Air Regulation No. SR-422 was adopted in July 1957 as a supplement to CAR 4b, containing airworthiness and operational requirements that were applicable to transport category airplanes powered by turbine engines (turbojet and turbopropeller). As experience was gained, SR-422 was amended in July 1958 (SR-422A) and July 1959 (SR-422B) to better reflect the operating environment of these new airplane designs. These Special Civil Air Regulations, presented in this appendix, formed the basis for the current transport category airworthiness and operating performance regulations of 14 CFR parts 25, 121, and 135. Though the number of operational airplanes that were certificated to these requirements is continually decreasing, these Special Civil Air Regulations, and the related preamble material, still provide a worthwhile perspective on many of the issues behind the development of today's regulations, and are therefore preserved for future reference in this appendix.

(2) All limitations, and any normal or abnormal operating procedures, associated with reverse thrust backing should be included in the Airplane Flight Manual (AFM). Any procedures related to ground crew functions should also be included in the AFM.

(3) Testing should be conducted to verify that the reverser efflux does not have a detrimental effect on the powerplant installations. Items to be considered include:

- (i) Foreign object damage (FOD);
- (ii) Effects on engine cooling;
- (iii) Inlet flow distortion;
- (iv) Reingestion of exhaust gases; and
- (v) Any effects on engine mounted accessories.

(4) Testing should be conducted to verify that the reverser efflux does not have a detrimental effect on other airplane systems such as air conditioning system inlets, APU inlets and exhausts, overboard drains, etc.

(5) It should be verified that cockpit and cabin air will not be contaminated.

NOTE: It is acceptable to have a limitation prohibiting the operation of the air conditioning packs during reverse thrust backing to avoid cockpit and cabin air contamination.

(6) Reverse thrust backing demonstrations should be conducted to evaluate the associated procedures. These demonstrations should be conducted at:

- (i) Maximum ramp weight with the c.g. at the aft limit, and
 - (ii) Any other weight that may be critical with the c.g. at the aft limit.
- (7) The reverse thrust backing demonstrations of paragraph (6), above, should be evaluated to determine:
- (i) The degree of aft pitching moment, including its effect on nose wheel steering;
 - (ii) The effect of inadvertent heavy/emergency braking action;
 - (iii) Adequate cockpit visibility and ground crew function;

(iv) The adequacy of procedures for transitioning from reverse to forward thrust;

(v) The effect of thrust asymmetry due to failure of an engine to enter reverse, or recover forward thrust mode;

(vi) The effects of low tire pressures;

(vii) The effect of ramp slope and surface condition;

(viii) The effects of ambient atmospheric temperature; and

(ix) The effect of flap/slat configuration.

with increased weight if a 5-degree bank angle is used. The requirement of § 25.149(c) that V_{MCA} not exceed $1.2V_S$ is based on V_S at maximum sea level takeoff weight. With the critical engine inoperative, the corresponding opposite engine should be adjusted to maximum takeoff power/thrust, and the airspeed decreased until heading can just be maintained with full rudder and no more than a 5-degree bank into the operating engine. For airplanes with more than two engines, the inboard engine(s) may be set to any thrust necessary to assist in developing the desired level of asymmetric thrust, or to achieve the desired flightpath angle (normally level flight).

(B) If the maximum asymmetric thrust that is permitted by the AFM operating limitations was maintained at the test day V_{MCA} , and the rudder pedal force did not exceed the limit specified in § 25.149(d), the resulting speed may be used as the single value of V_{MCA} for the airplane. If, at the option of the applicant, the AFM value of V_{MCA} is to vary with pressure altitude and temperature, the test day minimum control speed and the corresponding thrust should be used to calculate an equivalent yawing moment coefficient (C_{N}). This C_{N} value may then be used to calculate V_{MCA} as a function of takeoff thrust, thus permitting V_{MCA} to be scheduled as a function of pressure altitude and temperature for takeoff data expansion and presentation in the AFM (See Appendix 3 for further discussion of V_{MCA} correction).

(C) If maximum allowable takeoff thrust could not be developed at the flight test conditions, but maximum rudder deflection was achieved, then the V_{MCA} value corresponding to sea level standard day maximum asymmetric thrust may be calculated from the C_N attained at the test value of V_{MCA} . Extrapolation using this constant C_N method is limited to 5 percent of the test day asymmetric thrust, and is only permitted if the rudder pedal force at the test day V_{MCA} was not more than 95 percent of the limit value specified in § 25.149(d). For extrapolation beyond 5 percent thrust, a more rigorous analysis is required, which includes all the applicable stability and control terms (See Appendix 3 for further discussion of V_{MCA} correction).

(D) If V_{MCA} could not be achieved due to stall buffet, or excessive rudder pedal force, a parametric investigation should be undertaken to determine whether V_{MCA} is limited by stall speed, maximum rudder deflection, or maximum allowable rudder pedal force (See Appendix 4).

(iii) Dynamic Test Procedures and Required Data.

(A) After the static V_{MCA} tests have been completed, dynamic engine cuts should be evaluated at a series of decreasing airspeeds to show that sudden engine failure at any speed down to the static V_{MCA} value meets the requirements of § 25.149. The dynamic V_{MCA} test is conducted by applying the maximum approved power/thrust to all outboard engines, stabilizing at the test airspeed, and then cutting fuel to the critical engine. It must be possible to recover to a constant heading, without deviating more than 20 degrees from the original heading, while maintaining the test airspeed, without reducing power/thrust on the operating engine(s), and without exceeding the rudder pedal force limit of § 25.149(d). If the dynamic tests result in a V_{MCA} greater than the static value, the increment between the static and dynamic V_{MCA} at the same altitude should be added to the sea level extrapolated value. If the dynamic value is less than the static value, the static V_{MCA} must be used for the AFM data expansion.

(B) If static V_{MCA} is near stall speed at the minimum practicable test weight, or if the thrust-to-weight ratio (T/W) results in a trimmed pitch attitude of more than 20 degrees, it is not feasible to attempt to accurately define a quantitative value of V_{MCA} using a sudden engine cut because of the dynamics of the rapid pitchdown maneuver required, and the hazard associated with a potential spin entry. Additionally, an extreme nose up attitude followed by an engine cut is not representative of an operational takeoff engine failure. Since § 25.107(e)(1)(ii) requires V_R to be not less than $1.05V_{MCA}$, and there is some additional speed increase prior to lift off, a transport airplane is typically never airborne below approximately $1.08V_{MCA}$. Therefore, instead of using the dynamic method to define V_{MCA} for these aircraft, with high T/W or stall speed coincident with V_{MCA} , it is more appropriate for a dynamic engine cut to be evaluated only for acceptable controllability, and at a more representative speed. For these airplanes, a dynamic engine cut should be evaluated at an airspeed of either $1.1V_S$ or $1.1V_{MCA}$ (static), whichever is greater. During the entry to, and recovery from this maneuver, all the requirements of § 25.149(d) must be met.

(C) For airplanes with rudder travel-limited V_{MCA} s that have increased thrust engines installed, with no changes to the airframe's geometric layout or dimensions, it may not be necessary to conduct dynamic V_{MCA} flight testing if the thrust has not increased more than 10 percent above the level at which dynamic V_{MCA} had previously been demonstrated (see Appendix 3 of this AC).

(3) Minimum Control Speed - Ground (V_{MCG}) - § 25.149(e).

(i) It must be demonstrated that, when the critical engine is suddenly made inoperative at V_{MCG} during the takeoff ground roll, the airplane is safely controllable if the takeoff is continued. During the demonstration, the airplane must not deviate more than 30 ft. (25 ft. prior to Amendment 25-42) from the pre-engine-cut projected ground track. The critical engine/for ground minimum control speed testing should be determined during the takeoff ground run using techniques similar to those described in paragraph 23b(1). If there is a significant difference in left and right rudder deflection, the loss of asymmetric propeller disc loading, due to near zero angle of attack during the takeoff roll, could result in the critical engine being on the opposite side of the airplane relative to the airborne minimum control speed tests.

(ii) Tests may be conducted by abruptly retarding the critical engine to idle to establish the minimum value of V_{MCG} . At least one fuel cut should be made at each maximum asymmetric thrust level desired to be certificated to investigate the more rapid thrust decay associated with this type of engine failure. At the applicant's option, to account for crosswind test conditions, the runs may be made on reciprocal headings, or an analytical correction may be applied to determine the zero crosswind value of V_{MCG} .

(iii) During determination of V_{MCG} , engine failure recognition should be provided by:

(A) The pilot feeling a distinct change in the directional tracking characteristics of the airplane; or

(B) The pilot seeing a directional divergence of the airplane with respect to the view outside the airplane.

(iv) Control of the airplane should be accomplished by use of the rudder only. All other controls, such as ailerons and spoilers, should only be used to correct any alterations in the airplane attitude and to maintain a wings level condition. Use of those controls to supplement the rudder effectiveness should not be allowed. Care should also be taken not to inadvertently apply brake pressure during large rudder deflections, as this will invalidate the test data.

(v) V_{MCG} testing should be conducted at the heaviest weight where V_{MCG} may impact the AFM V_1 schedule.

(vi) V_{MCG} testing should be conducted at aft c.g. and with the nose wheel free to caster, to minimize the stabilizing effect of the nose gear. If the nose wheel does not caster freely, the test may be conducted with enough nose up elevator applied to lift the nose wheel off the runway.

(vii) For airplanes with certification bases prior to Amendment 25-42, V_{MCG} values may be demonstrated with nose wheel rudder pedal steering operative for dispatch on wet runways. The test should be conducted on an actual wet runway. The test(s) should include engine failure at or near a minimum V_{FE} associated with minimum V_{FE} to demonstrate adequate controllability during rotation, lift-off, and the initial climbout. The V_{MCG} values obtained by this method are applicable for wet or dry runways only, not for icy runways.

(4) Minimum Control Speed During Approach and Landing V_{MCA} - § 25.149(f).

(i) This section is intended to ensure that the airplane is safely controllable following an engine failure during an all-engines-operating approach and landing. From a controllability standpoint, the most critical case consists of an engine failing after the power or thrust has been increased to perform a go-around from an all-engines-operating approach. Section 25.149(f) requires the minimum control speed to be determined that allows a pilot of average skill and strength to retain control of the airplane after the engine becomes inoperative and to maintain straight flight with less than 5 degrees of bank angle. Section 25.149(b) requires that sufficient lateral control be available at V_{MCA} to roll the airplane through an angle of 20 degrees, in the direction necessary to initiate a turn away from the inoperative engine, in not more than five seconds when starting from a steady straight flight condition.

operation of the automatic propeller drag reduction system on an operating engine, following its operation on the failed engine, should be shown to be extremely improbable (on the order of 10^{-9} per flight hour).

(4) If performance credit is given for operation of the automatic propeller drag reduction system in determining the accelerate-go takeoff distances, the propeller of the failed engine must also remain in the reduced drag position in determining the accelerate-stop distances.

(5) In determining the brake application speed for the maximum energy rejected takeoff demonstration of § 25.109(g), consideration should be given to the accelerate-stop configuration (all-engines-operating vs. engine failure with automatic propeller drag reduction system operation) that will produce the greatest brake energy absorption requirement.

(6) The limitations section of the Airplane Flight Manual should contain a requirement for a flight crew functional check of the automatic propeller drag reduction system. The frequency with which flight crew functional checks and ground maintenance checks of the automatic propeller drag reduction system are required will be considered in the evaluation of the system reliability.

(7) Clear announcements should be provided to the flight crew for the following:

(i) The automatic propeller drag reduction system is "ARMED."

(ii) A malfunction exists in the automatic propeller drag reduction system.

242. AIRPLANE BACKING USING REVERSE THRUST.

a. Explanation. Where compliance with applicable airworthiness requirements has been demonstrated, operational approval has been granted for the use of reverse thrust to back airplanes away from airport gates in the of a tug pushback. The applicable airworthiness requirements are prescribed in paragraph b, below. Note that compliance with these requirements only demonstrates the capability of the airplane, and does not constitute operational approval; operational approval should be coordinated with the applicable FAA Flight Standards office.

b. Procedures. To obtain airworthiness approval for reverse thrust backing, compliance should be demonstrated with the criteria prescribed below. Since operational approvals for reverse thrust backing specify the applicable FAA Flight Standards office.

(1) Both the airplane and engine manufacturer should determine the applicability of the maneuver and provide appropriate limitations for the procedure. These limitations should include:

(i) Engine power setting and operating parameter limits;

(ii) Minimum and maximum allowable weights;

(iii) Center of gravity (c.g.) limits;

(iv) Ramp slope limits;

(v) Use of wheel brakes;

(vi) Atmospheric conditions (see NOTE below); and

(vii) Any other factor unique to the proposed operation.

NOTE: The use of reverse thrust backing with snow, ice, or slush on the ramp, or during periods of heavy rain, is not considered good operating practice.

(vii) All affected cockpit placards and displays must be revised to reflect the alternate forward c.g. limits.

(2) **Operational Criteria.**

- (i) Training and operational procedures, emphasizing the need for accurate weight and balance control, should be implemented. These procedures should address weight and balance knowledge of any given airplane, loading plans and procedures, dispatch responsibilities and procedures, and flightcrew awareness.
- (ii) Before an operator implements alternate forward c.g. limit operations, each airplane that will be used in those operations should be weighed and its Operating Empty Weight (OEW) and center of gravity location determined. This process should be repeated on an annual basis to assure accurate knowledge of the empty airplanes' c.g. positions.
- (iii) Operators seeking takeoff performance credit for alternate forward c.g. limits should provide evidence that their loading plans and procedures result in the c.g. location of any affected airplane being known to within 1 percent mean aerodynamic chord (MAC).
- (iv) Operators with mixed fleets of a particular airplane type (i.e., more than one "operator specific variant" of a type) should provide evidence of having an accurate control system to eliminate the potential for loading errors.
- (v) If the Flight Management System (FMS) databases have not been modified to reflect the effect of the alternate forward c.g. limits on performance (e.g., takeoff speeds) and fuel consumption, a limitation must be placed in the appropriate operating manuals that prohibits the use of the FMS when operating with an alternate forward c.g. limit.
- (vi) All affected documents (Weight and Balance manuals, Flight Crew Operating Manual, etc.) should be revised to reflect the alternate forward c.g. limits. These documents should also note any restrictions associated with their use.

2.41. **PERFORMANCE CREDIT FOR AUTOMATIC PROPELLER DRAG REDUCTION DEVICES.**

a. **Explanation.** In the description of takeoff path requirements, § 25.111(c)(4) states, in part, that "no change in power or thrust that requires action by the pilot may be made, until the airplane is 400 feet above the takeoff surface." This can result in significant takeoff performance penalties for propeller driven airplanes if the propeller on the critical inoperative engine remains in takeoff pitch, or assumes some other high drag windmilling pitch. Devices that automatically reposition an engine's propeller to a blade angle that reduces its drag contribution (e.g., autofeather systems), upon failure of the engine, can provide significant takeoff performance gains. Performance credit has been approved for the operation of these automatic propeller drag reduction devices, below 400 feet above the takeoff surface, when compliance with the criteria described below has been shown.

b. **Procedures.**

- (1) Propeller pitch setting generally has a significant effect on minimum control speeds and airplane drag. The magnitude of these effects is such that continued safe flight may not be possible should a combined failure of an engine and its automatic propeller drag reduction system occur at a takeoff speed based on operation of that system. Consequently, in accord with the stipulations of § 25.1309(b)(1), the probability of this combined failure must be shown to be extremely improbable (on the order of 10^{-9} per flight hour).
- (2) In determining the combined engine and automatic propeller drag reduction system failure rate of paragraph (1) above, the engine failure rate should be substantiated. Notwithstanding the in-service engine failure rate, the failure of the automatic propeller drag reduction system should be shown not to exceed 10^{-4} per flight hour.
- (3) The automatic propeller drag reduction system should be designed so that it will automatically be disabled on the operation engine(s) following operation on the failed engine. The probability of an unwanted

(ii) Conduct this test using the most critical of the all-engines-operating approach and landing configurations or, at the option of the applicant, each of the all-engines-operating approach and landing configurations. The procedures given in paragraphs 23b(2)(ii) and (iii) for V_{MCA} may be used to determine V_{MCL} , except that flap and trim settings should be appropriate to the approach and landing configurations, the power or thrust on the operating engine(s) should be set to the go-around power or thrust settings, and compliance with all V_{MCL} requirements of §§ 25.149(f) and (h) must be demonstrated.

(iii) For propeller driven airplanes, the propeller must be in the position it achieves without pilot action following engine failure, assuming the engine fails while at the power or thrust necessary to maintain a three degree approach path angle.

(iv) At the option of the applicant, a one-engine-inoperative landing minimum control speed, $V_{MCL1(00)}$, may be determined in the conditions appropriate to an approach and landing with one engine having failed before the start of the approach. In this case, only those configurations recommended for use during an approach and landing with one engine inoperative need be considered. The propeller of the inoperative engine, if applicable, may be feathered throughout. The resulting value of $V_{MCL1(00)}$ may be used in determining the recommended procedures and speeds for a one-engine-inoperative approach and landing.

(5) **Minimum Control Speed with Two Inoperative Engines During Approach and Landing (V_{MCL2}) - § 25.149(g).**

(i) For airplanes with three or more engines, V_{MCL2} is the minimum speed for maintaining safe control during the power or thrust changes that are likely to be made following the failure of a second critical engine during an approach initiated with one engine inoperative.

(ii) For propeller driven airplanes, the propeller of the engine that is inoperative at the beginning of the approach may be in the feathered position. The propeller of the more critical engine must be in the position it automatically assumes following engine failure.

(iii) Conduct this test using the most critical approved one-engine-inoperative approach or landing configuration (usually the minimum flap deflection), or at the option of the applicant, each of the approved one-engine-inoperative approach and landing configurations. The following demonstrations are required to determine V_{MCL2} :

(A) With the power or thrust on the operating engines set to maintain a minus 3 degree glide-slope with one critical engine inoperative, the second critical engine is made inoperative and the remaining operating engine(s) are advanced to the go-around power or thrust setting. The V_{MCL2} speed is established by the procedures presented in paragraphs 23b(2)(ii) and (iii) for V_{MCA} , except that flap and trim settings should be appropriate to the approach and landing configurations, the power or thrust on the operating engine(s) should be set to the go-around power or thrust setting, and compliance with all V_{MCL2} requirements of §§ 25.149(g) and (h) must be demonstrated.

(B) With power on the operating engines set to maintain a minus 3 degree glide-slope, with one critical engine inoperative:

- (1) Set the airspeed at the value determined above in step (A) and, with zero bank angle, maintain a constant heading using trim to reduce the control force to zero. If full trim is insufficient to reduce the control force to zero, full trim should be used plus control deflection as required; and
- (2) Make the second critical engine inoperative and retard the remaining operating engine(s) to minimum available power without changing the directional trim. The V_{MCL2} determined in paragraph (A) is acceptable if constant heading can be maintained without exceeding a 5 degree bank angle and the limiting conditions of § 25.149(h).

(C) Starting from a steady straight flight condition, demonstrate that sufficient lateral control is available at V_{MCL2} to roll the airplane through an angle of 20 degrees in the direction necessary to initiate a turn away from the inoperative engines in not more than five seconds. This maneuver may be flown in a bank-to-bank roll through a wings-level attitude.

- (iv) At the option of the applicant, a two-engines-inoperative landing minimum control speed, $V_{MC1-2(2\text{eng})}$, may be determined in the conditions appropriate to an approach and landing with two engines having failed before the start of the approach. In this case, only those configurations recommended for use during an approach and landing with two engines inoperative need be considered. The propellers of the inoperative engines, if applicable, may be feathered throughout. The values of V_{MC1-2} or $V_{MC1-2(2\text{eng})}$ should be used as guidance in determining the recommended procedures and speeds for a two-engines-inoperative approach and landing.
- (6) Autofeather Effects. Where an autofeather or other drag limiting system is installed, and will be operative at approach power settings, its operation may be assumed in determining the propeller position achieved when the engine fails. Where automatic feathering is not available, the effects of subsequent movements of the engine and propeller controls should be considered, including fully closing the power lever of the failed engine in conjunction with maintaining the go-around power setting on the operating engines.

c.g. limit, and present the resulting AFM performance for that same extreme forward c.g. limit. However, no corresponding requirement exists for presentation of AFM data in § 25.1583 (Operating Limitations) or § 25.1587 (Performance Information) that would limit the performance information to being presented for only the most extreme unfavorable center of gravity obtainable for a particular airplane. In the context of the part 25 airworthiness requirements, it would be acceptable to specify alternate forward c.g. limits as operating limitations, and provide takeoff performance that represents the capability of the airplane at those c.g. limits.

(5) The primary concern in granting performance credit for forward c.g. limits, aft of the extreme forward limit, relates to the diminishment of the conservative performance margin that resulted from generally operating with the c.g. some measurable increment aft of the extreme forward limit, upon which the takeoff performance is based. With the availability of alternate forward c.g. limits, this intrinsic performance margin will be decreased, and on a statistical basis, completely eliminated more often. Consequently, emphasis must be put on maintaining accurate weight and balance records, implementing accurate loading plans, and providing the necessary training and operating procedures for ground and dispatch personnel.

(6) Flight crew training is also a concern for alternate forward c.g. limit operations. With many of today's transport category airplanes incorporating high levels of cockpit automation (e.g., Flight Management Systems), it is imperative that the flightcrew be aware of when an alternate forward c.g. limit is being used as the basis for computing takeoff performance data. This is of critical import when an alternate forward c.g. limit is used in conducting a performance-limited takeoff. Since the aforementioned automated onboard systems may or may not be reprogrammed to accommodate the necessary performance data, it should be emphasized that the forward c.g. limit provided by the ground operations and dispatch personnel takes precedence over that shown by any onboard systems.

c. Procedures. Approval may be granted for as many as two alternate forward c.g. limits (for a total of three), with associated takeoff performance credit, provided the following certification and operational criteria are complied with:

(1) Certification Criteria.

(i) No more than two alternate forward c.g. limits (three total) may be approved per operator-specific variant of a particular airplane type and model. "Airplane type" refers to those airplanes of similar design as identified on the Type Certificate; "airplane model" refers to different versions of an airplane type as reflected on the Type Certificate. An "operator specific variant" is an airplane type and model outfitted to a particular customer's requirements (e.g., engine type, seat pitch, galley locations, etc.). For control purposes, airplanes that are classified as an "operator specific variant" must be clearly identifiable as such; this can be accomplished by definitive AFM document numbering systems and AFM's tied to specific airplane serial numbers.

(ii) The alternate forward c.g. limits should be sufficiently different that they will be treated as discrete limits and not result in confusion when determining takeoff performance adjustments.

(iii) The c.g. range that results from the use of an alternate forward c.g. limit must be of sufficient magnitude to be practical and allow for expected variations in operational loading.

(iv) The alternate forward c.g. limits must be identified as such and presented on the Weight and Center of Gravity chart in the Limitations section of the basic AFM. That chart should also provide a reference to a separate appendix to the AFM that contains the related airplane performance adjustments.

(v) To minimize the impact on crew training and standardization of cockpit procedures, it is preferable that onboard Flight Management Systems (FMS) be modified to include the performance and fuel management data associated with the alternate forward c.g. limits. If the FMS is not modified in such a manner, a limitation must be added to the AFM that prohibits the use of the FMS when using an alternate forward c.g. limit.

(vi) The AFM performance associated with alternate forward c.g. limit operations must be substantiated by flight test data. This does not mean that flight test data needs to be obtained at every alternate forward c.g. limit; the intent is for the applicant to verify the analytical predictions of c.g. effect with flight test data collected at different c.g.'s.

239. INSTRUMENT LANDING SYSTEM WEATHER MINIMA.

a. **Explanation.** The all weather categories, as presented by the International Civil Aviation Organization (ICAO), are defined as follows:

- (1) Category I - 200 feet (60 meters) ceiling, 2600 feet (800 meters) runway visual range (RVR).
- (2) Category II - 100 feet (30 meters) ceiling, 1200 feet (400 meters) RVR.
- (3) Category III
 - (i) Category IIIA - No decision height, 700 feet (200 meters) RVR.
 - (ii) Category IIIB - No decision height, no external reference and 150 feet (50 meters) RVR.
 - (iii) Category IIIC - No decision height, no external reference for landing or taxi.

b. **Procedures.** The criteria for airworthiness certification of Category II and III all weather operations are contained in Advisory Circular 120-29, "Criteria for Approving Category I and Category II Landing Minima for FAR 121 Operators," dated September 25, 1970, and Advisory Circular 120-28C, "Criteria for Approval of Category III Landing Weather Minima," dated March 9, 1984, respectively.

240. TAKEOFF PERFORMANCE CREDIT FOR ALTERNATE FORWARD CENTER OF GRAVITY LIMITS.

a. **Applicable Regulations.** Sections 25.23, 25.103, 25.105, 25.107, 25.109, 25.111, 25.113, 25.115, and 25.121 of the Federal Aviation Regulations.

b. Explanation.

- (1) In the early 1970s, approvals were granted for one alternate forward center of gravity (c.g.) limit per manufacturer's airplane model (e.g., DC-10 Series 40, B737-300, A300-600, etc.). These approvals included Airplane Flight Manual (AFM) performance information that took credit for the improved takeoff performance available with a further aft forward c.g. limit. The effect of this was that all operators of a manufacturer's airplane model (e.g., B737-300) would have the same alternate forward c.g. limit that may or may not afford any takeoff performance benefit, depending on any one operator's interior configuration, loading, and route structure.
- (2) Since those early approvals, the commercial aviation market has changed considerably, with many transport category airplanes capable of fulfilling more than one mission requirement in an operator's fleet. This is particularly true for modern extended range operation two-engine airplanes, most of which were derived from an earlier medium range version of the same basic airplane type. When these airplanes are used in long range operations, the c.g. can be considerably aft of the forward limit, upon which the takeoff performance is based, due to large fuel loadings. The advent of integral horizontal stabilizer fuel tanks has also led to a further aftward shift of the center of gravity. Some operators use these same long range airplanes on short to medium length routes, with the c.g. further forward than that of the long range operations, but still significantly aft of the forward c.g. limit.
- (3) The operational flexibility of many of today's transport category airplanes can be enhanced by taking credit for the improvements in takeoff performance afforded by a c.g. that is aft of the forward limit. The reductions in stall speeds and airplane drag render increased takeoff weights for a given field length and takeoff flight path profile. The approval of takeoff performance for two alternate forward c.g. limits would provide this type of operator with increased flexibility in operating the same airplane model on both long range, and short to medium range routes.
- (4) The concept of having alternate forward c.g. limits, with associated improvements in takeoff performance, does not conflict with any of the airworthiness or operational requirements of the Federal Aviation Regulations. Sections 25.103(a)(4) and 25.117 state that compliance with the stall speed and climb performance requirements, respectively, must be shown with the "most unfavorable center of gravity" position. Historically, this has been interpreted as a requirement to conduct the associated performance flight testing at the extreme forward

Section 5. STABILITY

25. GENERAL - § 25.171. (RESERVED)

26. STATIC LONGITUDINAL STABILITY AND DEMONSTRATION OF STATIC LONGITUDINAL STABILITY - §§ 25.173 AND 25.175.

a. Explanation

(1) Section 25.173 - Static Longitudinal Stability.

(i) Compliance with the general requirements of § 25.173 is determined from a demonstration of static longitudinal stability under the conditions specified in § 25.175.

(ii) The requirement is to have a pull force to obtain and maintain speeds lower than trim speed, and a push force to obtain and maintain speeds higher than trim speed. There may be no force reversal at any speed that can be obtained, except lower than the minimum for steady, unstalled flight or; higher than the landing gear or wing flap operating limit speed or V_{FC}/M_{FC} , whichever is appropriate for the test configuration. The required trim speeds are specified in § 25.175.

(iii) When the control force is slowly released from any speed within the required test speed range, the airspeed must return to within 10 percent of the original trim speed in the climb, approach, and landing conditions, and return to within 7.5 percent of the trim speed in the cruising condition specified in § 25.175 (free return).

(iv) The average gradient of the stick force versus speed curves for each test configuration may not be less than one pound for each 6 knots for the appropriate speed ranges specified in § 25.175. Therefore, after each curve is drawn, draw a straight line from the intersection of the curve and the required maximum speed to the trim point. Then draw a straight line from the intersection of the curve and the required minimum speed to the trim point. The slope of these lines must be at least one pound for each 6 knots. The local slope of the curve must remain stable for this range.

NOTE: Due to different design features of individual airplanes, there may be cases where the local slope gradient deviates somewhat from that specified by § 25.173. When this occurs, an investigation should be performed to determine if a finding of equivalent safety can be made based on pilot evaluation.

(2) Section 25.175, Demonstration of Static Longitudinal Stability, specifically defines the flight conditions, airplane configurations, trim speed, test speed ranges, and thrust settings to be used in demonstrating compliance with the longitudinal stability requirements.

b. Procedures.

(1) For the demonstration of static longitudinal stability, the airplane should be trimmed in smooth air at the conditions required by the regulation. Air c.g. loadings are

(11) The numbering and designation of systems in the CDL appendix is based on Air Transport Association (ATA) Specification 100. The parts within each system are identified by functional description and, when necessary, by part numbers.

237. SPARE ENGINE POD.

a. **Explanation.** When a spare engine pod is installed, the performance and flight characteristics that are affected by the installation must be evaluated.

b. **Procedures.** The drag increment due to the spare engine pod installation is normally determined by the drag polar method described in paragraph 17b(1)(ii) of this AC. Check climbs are performed to verify the performance penalties derived from the drag data. These check climbs will normally be conducted in the airplane configuration corresponding to the limiting takeoff performance segment. Performance stalls should be conducted for a minimum of one takeoff and one landing flap setting to determine any effect of the spare engine pod installation on stall speeds and handling characteristics in the stalling maneuver. Vibration and buffeting (§ 25.251), flutter (§ 25.629), and the maximum operating limit speed (§ 25.1505) may also require flight demonstration with the spare engine and pod installed. Longitudinal control (§ 25.145), directional and lateral control (§ 25.147), and ability to trim (§ 25.161) should be demonstrated with the spare engine and pod installed.

238. AUTHORIZATION FOR FERRY FLIGHT WITH ONE ENGINE INOPERATIVE - § 91.611.

a. **Explanation.** Section 91.611 provides an allowance for the ferry flight of "... a four-engine airplane or a turbine-engine-powered airplane equipped with three engines, with one engine inoperative, to a base for the purpose of repairing that engine...". This allowance is provided for airplanes operated in accordance with Parts 121 and 125 of the FAR. Section 91.611 also provides performance and operating criteria, including references to sections of Part 25, that must be met in order to obtain a one-engine-inoperative ferry-flight permit.

b. **Procedures.** Section 91.611(a)(1) requires the subject airplane be flight tested to show satisfactory compliance with the requirements of §§ 91.611(b) or (c) for reciprocating and turbine engine powered airplanes, respectively. Deviations from the flight tested configuration may be approved, based on a conservative analysis as described in paragraph 235 of this AC. An example of such a deviation would be a turbojet powered airplane with a one-engine-inoperative ferry flight approval, based on a flight test with the inoperative engine windmilling being subsequently approved for flight with a locked rotor. Though the one-engine-inoperative ferry is an operational approval and not a change in the type design, the airplane performance with the locked rotor should be treated in the same manner as a "Minor Design Change," and the associated drag increment computed conservatively as described in paragraph 235. The pertinent regulatory sections are described below.

(1) Section 91.611(a)(2) requires the approved Airplane Flight Manual (AFM) to contain limitations, operating procedures, and performance information, including a description of the configuration of the inoperative propeller (i.e., engine). This requirement implicates all the processes normally associated with Part 25 AFMs.

(2) Sections 91.611(c)(1) and (2) require flight tests to be conducted, in the propeller (i.e., engine) configuration desired for approval, to determine takeoff speeds and distances for one-engine-inoperative ferry operations.

(3) Section 91.611(c) refers to the general performance requirements of § 25.101, the takeoff speed requirements of § 25.107, and the climb requirements of § 25.121, thus tying the one engine inoperative ferry performance to the type design criteria.

(4) Section 91.611(c)(5) states the airplane must be satisfactorily controllable in a climb with two critical engines inoperative and the climb performance "...may be shown by calculations based on, and equal in accuracy to, the results of testing."

(5) Section 25.21(a)(1), Proof of Compliance, states the same allowance for calculated performance if it is "...based on, and equal in accuracy to, the results of testing." Based on this statement, and the previously noted references of § 91.611 to sections of Part 25, it is permissible to calculate one-engine-inoperative ferry performance for a configuration that differs from that flight tested. In such cases the conservative methods described in paragraph 235 of this AC should be used.

(ii) Only a single weight decrement for the one-engine-inoperative and two-engine-inoperative enroute climb performance will be permitted.

(iii) The CDL shall contain explanations of the takeoff performance decrement, the landing performance decrement, and the enroute performance decrement, as appropriate for the airplane, when the three decrements are used.

(2) No reduction in V_{MO}/M_{YO} will be required if it can be shown by flight test that no significant changes of flight characteristics, or other adverse airworthiness effects exist up to V_{MO}/M_{MO} and a rational analysis is made for speeds up to V_T/M_T to show no deterioration of airplane control characteristics. Basis for the rational analysis will primarily be the proximity of the missing part to aerodynamic surfaces. If a reduction in V_{MO}/M_{YO} is required, the maximum allowable airspeed indicator and aural warning, required by §§ 25.1303(b)(1) and (c)(1), must be rescheduled for the reduced speed.

c. General Limitations. The following information should be presented in the CDL appendix:

(1) When the airplane is operated using the CDL, it must be operated in accordance with the limitations specified in the AFM, as amended in the CDL.

(2) The associated limitations must be listed on a placard affixed in the cockpit in clear view of the pilot in command and other appropriate crewmember(s).

(3) The pilot in command should be notified of each operation with a missing part(s) by listing the missing part(s) in the flight or dispatch release.

(4) The operator should list in the airplane logbook an appropriate notation covering the missing part(s) on each flight.

(5) If an additional part is lost in flight, the airplane may not depart the airport at which it landed following this event, until it again complies with the limitations of the CDL. This, of course, does not preclude the issuance of a ferry permit to allow the airplane to be flown to a point where the necessary repairs or replacements can be made.

(6) No more than one part for any one system (e.g., one engine pylon fairing) may be missing, unless specific combinations of parts are included in the CDL. Unless otherwise specified, parts from different systems may be missing. The performance penalties are cumulative, unless specifically designated penalties are indicated for the combination of missing parts.

(7) No more than three parts that have each been determined to cause a negligible performance degradation may be missing for takeoff without applying a performance penalty. When more than three such parts are missing, a performance penalty of either 0.5 percent of the maximum takeoff weight or 100 pounds, whichever is less, must be applied for takeoff, en route, and landing for each missing part.

(8) Takeoff performance penalties should be applied to the takeoff weights that are limited by performance considerations (i.e., takeoff field length, first, second, or final segment climb, or takeoff flight path). If the performance-limited takeoff weight is greater than the maximum certified takeoff weight, the takeoff performance penalties should be applied to the maximum certified takeoff weight to ensure compliance with the noise requirements.

(9) Landing performance penalties should be applied to the landing weights that are limited by performance considerations (i.e., landing field length, landing climb, or approach climb). If the performance-limited landing weight is greater than the maximum certified landing weight, the landing performance penalties should be applied to the maximum certified landing weight to ensure compliance with the noise requirements.

(10) En route performance penalties apply only to operations that are limited by the one- or two-engine(s) inoperative en route climb performance.

generally most critical. After obtaining trim speed, apply a light pull force and stabilize at a slower speed. Continue this process in acceptable increments, depending on the speed spread being investigated, until reaching the minimum speed for steady, unstalled flight or the minimum required as appropriate for the configuration. A continuous pull force from the trim speed is required on each series of test points to eliminate hysteresis effects. At the end of the required speed range, the force should be gradually relaxed to allow the airplane to slowly return toward the trim speed and zero stick force. Depending on the amount of friction in the control system, the eventual speed at which the airplane stabilizes will normally be less than the original trim speed. The new speed, called the free return speed, must meet the requirements of § 25.173.

(2) Starting again at the trim speed, push forces should be gradually applied and gradually relaxed in the same manner as described in paragraph (1), above.

(3) The above techniques result in several problems in practice. One effect of changing airspeed is a change of altitude, with a corresponding change in Mach number and thrust or power output. Consequently, a reasonably small altitude band, limited to $\pm 3,000$ ft, should be used for the complete maneuver. If the altitude band is exceeded, regain the original trim altitude by changing the power setting and flap and gear position, but without changing the trim setting. Then continue the push or pull maneuver in the original configuration. Testing somewhat beyond the required speed limits in each direction assures that the resulting data at least extends to the required speed ranges. It will also be noted in testing that while holding force constant at each data point, the airspeed and instantaneous vertical speed vary in a cyclic manner. This is due to the long period (phugoid) oscillation. Care should be exercised in eventing the data point, since it may be biased by this phugoid oscillation. Averaging these oscillating speeds at each data point is an acceptable method of eliminating this effect.

Extremely smooth air improves the quality of the test data, with critical areas requiring the best of smooth air. In-bay and cross-bay wing fuel shift is another problem experienced in some airplanes. In-bay fuel shift occurs rapidly with pitch angle; therefore, consideration should be given to testing with fuel loadings that provide the maximum shift since it is generally destabilizing. Slower, cross-bay fuel shift, or burn from an aft tank, can influence the measured stability but usually only because of the time required to obtain the data points. This testing induced instability should be removed from the data before evaluation of the required slope.

(4) The resulting pilot longitudinal force test points should be plotted versus airspeed to show the positive stable gradient of static longitudinal stability and that there are no "local" reversals in the stick force vs. airspeed relationship over the range of airspeeds tested. This plot should also show the initial trim point and the two return-to-trim points to evaluate the return-to-trim characteristics (see Figure 26-1).

FIGURE 26-1. LONGITUDINAL STATIC STABILITY

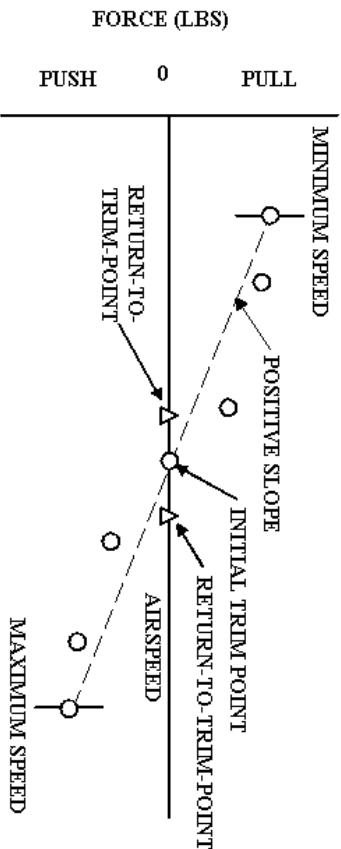

27. STATIC DIRECTIONAL AND LATERAL STABILITY - § 25.177.

a. Explanation

(1) Static Directional Stability. Positive static directional stability is defined as the tendency to recover from a skid with the rudder free. Prior to Amendment 25-72, a separate demonstration of positive static directional stability was required by § 25.177(a) for any landing gear and flap position and symmetrical power condition at speeds from $1.2V_{SI}$ up to V_{FE} ; V_{LE} ; or V_{FC}/M_{FC} , as appropriate for the airplane configuration.

(2) Static Lateral Stability. Positive static lateral stability is defined as the tendency to raise the low wing in a sideslip with the aileron controls free. Prior to Amendment 25-72, a separate demonstration was required by § 25.177(b) to show that static lateral stability was not negative in any landing gear and flap position and symmetrical power condition at speeds from $1.2V_{SI}$ to V_{FE} ; V_{LE} ; or V_{MO}/M_{MO} , as appropriate for the airplane configuration. At speeds from V_{MO}/M_{MO} to V_{FC}/M_{FC} , negative static lateral stability was permitted by § 25.177(b), providing the divergence was:

- (i) Gradual;
 - (ii) Easily recognizable by the pilot; and
 - (iii) Easily controllable by the pilot.
- (3) Steady Straight Sideslips.
- (i) Section 25.177(c) requires, in steady, straight sideslips to sideslip angles appropriate to the operation of the airplane, that the aileron and rudder control movements and

(iii) The performance section should include the performance determined and approved under paragraph (2) of this section, accounting for any special procedures required. No credit for cleanway and/or stopway should be allowed.

235. ACCOUNTABILITY OF PERFORMANCE DEGRADATION RELATIVE TO BOTH MINOR DESIGN CHANGES (EXTERNAL EXPOSURE) AND CONFIGURATION DEVIATION LIST (CDL) ITEMS.

a. Explanation. When minor changes to the type design or a Configuration Deviation List (CDL) item, which have external exposure (e.g., installation of wing up-rouned emblem lights, missing flap hinge covers, etc.), have been submitted for FAA approval, the consideration of applicable performance degradation has frequently presented a problem. This problem materialized when the assessed performance penalty (in terms of gross weight decrements) was very small and the applicant was of the opinion that the numerical value was so small as to be negligible. However, the resulting Supplemental Type Certificate (STC) usually required an Airplane Flight Manual (AFM) supplement, which contained a performance limitation requiring an applicable gross weight decrement or, in the case of the CDL, a gross weight decrement was listed as a certificate limitation.

b. Procedures. The following criteria were developed with simplicity as a prime objective and yet encompassing a practical resolution of many airworthiness and operational considerations. Some of these considerations were the tolerances applicable to flight test performance data scatter and computerized operational performance/runway planning data, accuracy of AFM performance charts, minimal obstacle clearance climb gradients, as well as weight and balance standard practices.

(1) One method to analytically assess the performance degradation of an aerodynamic configuration change is to estimate the drag value and then increase that by a factor of 2. The resulting degradations in takeoff field length and climb, enroute climb, and approach/landing climb should be determined in terms of airplane weight. For airplanes with maximum takeoff gross weights not exceeding 20,000 lbs., performance weight decrements less than 0.5 percent of maximum takeoff weight for the takeoff and enroute cases (or 0.5 percent of maximum landing weight for the approach/landing climb cases) may be considered negligible; for airplanes with maximum takeoff gross weights greater than 20,000 lbs., performance weight decrements of 100 lbs. may be considered negligible. The AFM supplement or CDL appendix should identify those type design changes or CDL items that result in a negligible performance degradation. If the performance degradation is not considered negligible, the appropriate performance penalty should be provided as a limitation in the AFM supplement or in the CDL appendix. Such procedures are considered as being a conservative alternative to a complete flight test analysis. Additionally, the information described under "General Limitations" in paragraph 236, following, should be presented in the CDL appendix.

(2) An alternative method of analytically assessing the performance degradation is to implement conservatism throughout the analysis through conservative roundoffs and chart readings, using worst-case assumptions, etc. The performance weight decrements are then implemented as noted in paragraph (1), above.

236. CONFIGURATION DEVIATION LIST.

a. Explanation. The parts and/or combinations of parts permitted to be missing, and the associated performance decrements and other limitations, shall be determined and presented in the Airplane Flight Manual Configuration Deviation List (CDL).

b. Procedures.

(1) Performance decrements should be computed as described in paragraph 235 of this AC. A single decrement applicable to all AFM performance limitations may be presented, or, subject to the following restrictions, performance decrements may be presented for the different flight regimes:

- (i) Only a single performance decrement for takeoff and a single performance decrement for landing will be permitted. For takeoff, the decrement will be the greatest decrement considering takeoff field length, first, second, and final segment climbs, and takeoff flight path. For landing, the decrement shall be the greatest decrement considering approach climb, landing climb, and landing field length.

(v) Climb performance should account for any additional drag or thrust loss due to special equipment installations.

(3) **Airplane Handling.** Airplane handling characteristics must meet the appropriate airworthiness requirements in each configuration specified for operation. Any special procedures or techniques associated with unpaved runway operation, such as use of thrust reversers, brakes, nose wheel steering, etc., should be identified.

(4) **Systems, Engine, and Structure.**

(i) It should be demonstrated that systems whose normal functions may be affected by operation from unpaved runways (e.g., anti-skid, nose wheel steering) continue to perform their intended function under all conditions for which approval is requested.

(ii) It should be determined that the airplane can be operated on each defined surface without hazard from likely impingement or engine ingestion of gravel or other surface material. In demonstrating that there is no hazard, consideration should be given to immediate effects such as mechanical damage, and to longer term effects, such as accumulation of loose runway material. These accumulations could cause jamming of flight controls, prevent configuration changes, or cause blockage of cooling ducts or drains. Also, sandblasting effects, from materials thrown by the tires, on the wings, propellers, and fuselage may result in surface erosion that, in time, may lead to more serious structural damage. To address these concerns, the test airplane, its engines, and any relevant systems should be inspected for surface damage after each accelerate-stop test and each takeoff/landing cycle.

(iii) The effect on landing gear fatigue life, due to operation on unpaved runway surfaces, should be determined.

(iv) It should be demonstrated that any special equipment, such as gravel deflectors or low pressure tires, does not adversely affect any of the AFM performance or ground handling characteristics previously established for the airplane on hard surface runways (e.g., water spray ingestion characteristics of the airplane).

(5) **Maintenance.**

(i) Any revised airplane maintenance procedures, such as increased frequency of inspections considered necessary to ensure safe operation of the airplane, should be determined and scheduled.

(ii) Runway maintenance procedures specific to the unpaved surface should be determined and scheduled (e.g., grading and sanding at, and just beyond, the touchdown point, and in the area where takeoff thrust is set, if those areas may be contaminated with ice or compact snow).

(6) **Airplane Flight Manual (AFM).** The limitations, procedures, and performance information for unpaved runway operation must be presented in an AFM appendix or supplement.

(i) The limitations section should include runway surface definitions as established under paragraph (1) above, for which the airplane has been approved to operate and for which suitable performance data has been determined and scheduled in accordance with paragraph (2). Approved airplane configurations, including any special equipment required, along with system limitations, should also be included. The following takeoff and landing limitations should be stated:

- (A) Reduced thrust takeoffs are prohibited.
 - (B) Dispatch with an inoperative antiskid system is prohibited.
 - (C) Dispatch with inoperative spoilers/lift dumpers is prohibited.
 - (D) Use of continuous ignition is required during the takeoff.
- (ii) The procedures section should include any special procedures (e.g., use of thrust reversers, nose wheel steering, rolling takeoff, air conditioning/pressurization configuration).

forces be proportional to the angle of sideslip and must lie between limits necessary for safe operation. Experience has shown that 15 degrees is an appropriate sideslip angle for transport category airplanes. Section 25.177(c) states that compliance with these steady, straight sideslip criteria "must be demonstrated for all landing gear and flap positions and symmetrical power conditions at speeds from $1.2V_{SI}$ to V_{FE} , V_{LE} , or V_{FC}/M_{FC} , as appropriate."

(ii) At sideslip angles greater than those appropriate for normal operation of the airplane, up to the sideslip angle at which full rudder travel is used or a rudder pedal force of 180 pounds is obtained, the rudder pedal forces may not reverse and increased rudder deflection must produce increased angles of sideslip. The goals of this higher-than-normal sideslip angle test are to show that at full rudder, or at maximum expected pilot effort: (1) the rudder pedal force does not reverse, and (2) increased rudder deflection produces increased angles of sideslip, thus demonstrating adequate directional stability for maneuvers involving large, dynamic rudder inputs, such as engine failure during takeoff just after V_1 . Consequently, it is permissible to continue this test beyond full lateral control input.

(iii) Section 25.177(d) (post-Amendment 25-72) stipulates that increased rudder deflection must continue to increase the angle of sideslip at speeds between V_{MO}/M_{MO} and V_{FC}/M_{FC} ; but the dihedral effect, as exhibited by aileron deflection opposite the corresponding rudder input, may become negative in this speed range, provided the divergence is:

- (A) Gradual;
- (B) Easily recognized by the pilot; and
- (C) Easily controlled by the pilot.

b. **Procedures.** The test conditions should include each flap and landing gear configuration as described in paragraphs 27a(1), (2) or (3), at both low altitude and the maximum altitude appropriate to each configuration.

(1) **Basic Test.**

(i) **Static Directional Stability.** To check static directional stability with the airplane in the desired configuration and stabilized at the trim speed, the airplane is slowly yawed in both directions while maintaining the wings level with ailerons. When the rudder is released, the airplane should tend to return to straight flight.

(ii) **Static Lateral Stability.** To check lateral stability with a particular configuration and trim speed, conduct steady, straight sideslips at the trim speed by maintaining the airplane heading with rudder and banking with aileron. When the ailerons are released, with the rudder held fixed, the low wing should tend to return to level. Initial bank angle should be appropriate to type; however, it is recommended that it should not be less than 10 degrees or that necessary to maintain the steady, straight sideslip with one-half rudder deflection, whichever occurs first. Roll control centering by the pilot should not be permitted during this evaluation. The intent of this testing is to evaluate the short-term response of the airplane; therefore long-term effects, such as those due to spanwise fuel movement, need not be taken into account.

(iii) Absence of Rudder Lock.

(A) Rudder lock is that condition where the rudder over-balances aerodynamically and deflects fully with no additional pilot input.

(B) To check for the absence of rudder lock with a particular configuration and trim speed, conduct steady, straight sideslips (unaccelerated forward slips) while maintaining a desired airplane track.

(C) Aileron and rudder control movements must remain in harmony, and forces must increase in proportion with sideslip angle, up to the limits found necessary for safe operation. At sideslip angles greater than those appropriate for normal operation of the airplane, up to the sideslip angle at which full rudder travel is used or a rudder pedal force of 180 pounds is obtained, the rudder pedal forces may not reverse; and increased rudder pedal deflection must produce increased angles of sideslip. The purpose of the second part of this test, at greater than normal sideslip angles, is to show that no rudder lock tendencies exist up to the rudder deflection limits as may be encountered during a dynamic rudder input to maintain directional control.

(2) Alternative Test. In lieu of conducting each of the qualitative tests described in paragraph 27(b1), the applicant may obtain recorded quantitative data showing aileron and rudder force and position versus sideslip (left and right) to the appropriate limits in constant heading sideslips.

(i) When determining the rudder and aileron forces, the controls should be relaxed at each point to find the minimum force required to hold the control surface deflection. If excessive friction is present, the resulting low forces will indicate the airplane does not have acceptable stability characteristics.

(ii) If the force and position versus sideslip indicates positive dihedral effect, positive directional stability and no rudder lock, compliance with § 25.177 has been successfully demonstrated.

(3) The control limits approved for the airplane should not be exceeded when conducting the flight tests required by § 25.177.

28. DYNAMIC STABILITY - § 25.181.

a. Explanation

(1) The dynamic stability tests described in this section should be conducted over the speed range of $1.2V_S$ to V_{FE} , V_{LE} or V_{FC}/M_{FC} , as appropriate.

(2) Dynamic Longitudinal Stability.

(i) The short period oscillation is the first oscillation the pilot sees after disturbing the airplane from its trim condition with the pitch control (as opposed to the long period (phugoïd)). Care should be taken that the control movement used to excite the motion is not too abrupt.

b. Procedures. The considerations described in paragraphs (1) through (6), below, should be addressed in obtaining approval for operation of transport category airplanes on unpaved runways.

(1) Surface Definition. Each type of surface should be defined so that it can be recognized, controlled, and maintained in service. The definition should include specification characteristics of the surface necessary for safe operation, such as:

(i) Surface and sub-base bearing strength, usually expressed as "California Bearing Ratio (CBR)." Measurements wet and dry every 500 feet along the runway centerline and 15 to 30 feet either side of the centerline have been used. Other means of defining the suitability of a runway surface to the operation of a particular airplane exist that classify runways based on their load bearing capability; one example is the Aircraft Classification Number (ACN) system employed by the International Civil Aviation Organization (ICAO).

(ii) Thickness, aggregate size, and depth of the surface material.

(iii) Presence of rutting.

(iv) Drainage.

(v) Presence of surface vegetation.

(2) Airplane Performance. If special equipment (e.g., low pressure tires, shields, deflectors) or special procedures are required, the effect of such equipment and/or procedures on airplane performance should be determined and presented in the Airplane Flight Manual (AFM); for example, landing gear retraction time may increase if deflectors are installed on the landing gear; necessitating changes to AFM first segment climb data.

(i) Takeoff, accelerate-stop, and landing performance should be demonstrated and scheduled in accordance with the appropriate airworthiness requirements based on each type of unpaved runway surface for which approval is requested. The flight test demonstrations should be conducted on both wet and dry surfaces. An abbreviated series of test conditions, relative to the test requirements of a conventional smooth, hard-surface runway test program, may be acceptable if reliable adjustments for all flap settings can be established to derive these data from the smooth, hard surface performance data. However, a minimum of four conditions each for takeoff, accelerate-stop, and landing should be conducted, and the heaviest weight demonstrated for takeoff and landing will establish the weight limitations for those modes of operation.

(ii) The test runway should be the actual runway for which approval is requested or be chosen to represent the worst characteristics (i.e., high rolling friction, low braking friction, etc.) of each type of unpaved runway for which approval is sought. In this regard, it may not be sufficient to conduct these tests from a runway with a low CBR. Previous tests have shown that rolling friction is primarily a function of CBR, but braking friction is primarily a function of runway surface characteristics and largely independent of CBR and, in some cases, whether the surface is wet or dry. The effects of other variables such as airplane weight and tolerances on recommended tire pressure should also be determined.

(iii) A V_{XCG} -demonstration should be conducted. Rudder pedal nose wheel steering may be used, provided the runway surface for the test represents the "worst case" anticipated for operation. The aerodynamic moment applied to the airplane by the rudder, combined with the use of rudder pedal nose wheel steering, may result in the nose wheel "plowing" the unpaved runway surface. This can result in the runway surface elements impacting critical airframe and powerplant surfaces. The test should be closely monitored to ensure this damage source does not exist. If the test is conducted with rudder pedal nose wheel steering:

(A) Credit may be taken for any performance benefit provided; and

(B) Dispatch without it is prohibited, regardless of whether credit for any performance benefit is taken.

(iv) Landing flare and touchdown characteristics should be evaluated during the landing performance tests.

speed abuse test is to account for an unnoticed speed decrease during the approach, hence the requirement in paragraph 2.33d(3)(i) for no power increase to account for the slower speed.

e. Engine-Out Operation.

- (1) It must be shown that the airplane is safely controllable during approach, landing, and during the transition to a go-around, using recommended operational speeds and procedures. This must be demonstrated after failure of the critical engine, while the airplane is stabilized on V_{REF} at the maximum approved approach path angle, and also at the approved angle plus 2°.
- (2) If the one-engine feathered thrust/drag characteristics are such that it is not possible to maintain the approved approach path angle plus 2 degrees without accelerating, then the airplane must either be able to maintain the approved approach path angle minus 2 degrees at V_{REF} in the landing configuration with one propeller windmilling (in which case it is permissible to continue the approach), or a go-around must be initiated following any engine failure. The results of this test will determine the appropriate engine-out configuration to be approved in the Airplane Flight Manual. If the airplane cannot maintain the approved approach path angle plus 2 degrees with the inoperative engine's propeller feathered without accelerating, or the approved approach path angle minus 2 degrees with the propeller windmilling, then the AFM limitations section must state that steep approaches are not approved with a failed engine and the airplane must divert to an alternate airport.

NOTE: The intent of this test is to determine an airplane configuration that allows adequate vertical flight path control to permit regaining the approved approach path following deviation from that path for any reason. If an engine failure occurs below DH/MDA, it is permissible to continue the approach with the propeller windmilling, without meeting the requirements of paragraph e(2), above, provided the airplane is safely controllable during the subsequent approach and landing.

f. Airplane Flight Manual.

- (1) Limitations, operating procedures, and performance information necessary for steep approach operations should be clearly identified as such.
- (2) The limitations section should note that the limitations, operating procedures, and performance information for steep approach operations are predicated on the use of an approved approach path guidance system.
- (3) The limitations section should specify the airplane configurations (i.e., flaps, gear, number of engines operating, etc.) for which steep approach operations are approved.
- (4) The landing weight limitations should include the most restrictive of the landing climb performance conditions, as determined by the approach climb requirements of § 25.121(d), the landing climb requirements of § 25.119, and the additional climb requirements specified in paragraph 2.33c(4) of this section.
- (5) The operating procedures and performance information should clearly identify the airplane configuration, screen height, and approach path angle that the steep approach landing distances are based upon.
- (6) The steep approach landing distances should be presented for standard day conditions and should include corrections for weight, altitude, and winds within the limits established for the airplane. Wind velocities should be factored in accordance with § 25.125(e). At the option of the applicant, corrections may also be presented for non-standard temperatures and runway slope.

234. TAKEOFF AND LANDING ON UNPAVED RUNWAYS.

a. **Explanation.** There are no specific regulatory requirements or established guidance material pertaining to transport category airplane airworthiness certification for operations on runway surfaces other than smooth and hard. However, several transport category airplanes have been certificated by the FAA for operation on various kinds of unpaved runways, including sod, dirt, and gravel. The following general guidance for airplane certification, for operation on unpaved surfaces, reflects the experience and policy developed during those certification programs.

(ii) Heavily damped means that the oscillation has decreased to 1/10 the initial amplitude within approximately two cycles after completion of the control input.

(iii) Short period oscillations must be heavily damped, both with controls free and controls fixed.

(3) Dynamic Lateral-Directional Stability. The evaluation of the dynamic lateral-directional stability should include any combined lateral-directional oscillation ("Dutch Roll") occurring over the speed range appropriate to the airplane configuration. This oscillation must be positively damped with controls free and must be controllable with normal use of the primary controls without requiring exceptional piloting skill.

b. Procedures.

(1) Dynamic Longitudinal Stability.

(i) The test for longitudinal dynamic stability is accomplished by a rapid movement or pulse of the longitudinal control in a nose up and nose down direction at a rate and degree necessary to obtain a short period pitch response from the airplane.

(ii) Dynamic longitudinal stability must be checked at a sufficient number of points in each configuration to assure compliance at all operational speeds.

(2) Dynamic Lateral-Directional Stability.

(i) A typical test for lateral-directional dynamic stability is accomplished by a rudder doublet input at a rate and amplitude that will excite the lateral-directional response ("Dutch Roll"). The control input should be in phase with the airplane's oscillatory response.

(ii) Dynamic lateral-directional stability must be checked under all conditions and configurations. If critical, special emphasis should be placed on adverse wing fuel loading conditions.

(3) Airplanes Equipped with Stability Augmentation Systems (SAS). In the event a SAS is required for the airplane to show compliance with §§ 25.181(a) or (b), it must meet the requirements of §§ 25.671 and 25.672. Additionally:

(i) If the airplane is equipped with only one SAS (i.e., a single strand system), compliance with the dynamic stability requirements of §§ 25.181(a) or (b), as applicable, must be shown throughout the normal operating flight envelope to be certificated with the SAS operating, and in a reduced, practical operating flight envelope that will permit continued safe flight and landing with the SAS inoperative.

(ii) If the airplane is equipped with more than one SAS, the resulting effects of SAS failure should be considered when determining whether or not the primary and any redundant SAS should be operating simultaneously for showing compliance with the dynamic stability requirements of §§ 25.181(a) or (b). If the primary and redundant SAS are dissimilar,

the functional capability (i.e., control authority) of the redundant SAS should be considered with regard to restricting the operating envelope after failure of the primary SAS. At the applicant's option, however, compliance with §§ 25.181(a) or (b) may still be demonstrated to a reduced flight envelope with no SAS operating as described in paragraph 28b(3)(i), above.

(iii) Regardless of the SAS redundancy, the airplane must be safely controllable at the point of system failure or malfunction anywhere in the approved operating flight envelope of the airplane. Accordingly, it should be demonstrated that the airplane remains controllable during transition from the operating SAS to any redundant SAS, and during transition from anywhere in the normal operating envelope to the reduced practical operating envelope of § 25.672(c), if applicable. Airplane controllability should be demonstrated to meet the following levels as defined by the FAA Handling Qualities Rating System (HQRS). (The FAA HQRS is described in Appendix 7 to this AC.)

(A) In the normal operating flight envelope with the SAS operating, the handling qualities should be "satisfactory" (SAT) as defined by the FAA HQRS.

(B) At the point of SAS failure in the normal operating envelope, the airplane should be "controllable" (CON), as defined by the FAA HQRS, during the short term transitory period required to attain a speed and configuration that will permit compliance with paragraph (C), below.

(C) During transition from the primary SAS to a redundant SAS, or from the normal operating envelope to a reduced, practical operating envelope (where applicable), the handling qualities should be "adequate" (ADO) as defined by the HQRS.

(D) In the reduced, practical operating flight envelope that will permit continued safe flight and landing, the handling qualities should be "satisfactory" (SAT) as defined by the HQRS.

(1) Approach path guidance must be used for all steep approaches. The landing screen height is 50 feet, unless stated otherwise (see paragraph 233c(3)(iii), below).

(2) In lieu of the wind tolerance specified in § 25.21(d), the wind for takeoff and landing performance tests may not exceed 5 knots along the runway, measured at a height of 6 feet above the runway.

(3) In lieu of the corresponding landing performance requirements of § 25.123(a), the horizontal distance necessary to land and come to a complete stop from the landing screen height must be determined (for standard temperatures, at each weight, altitude, and wind within the operational limits established by the applicant for the airplane) as follows:

(i) The airplane must be in the appropriate landing configuration.

(ii) A steady approach must be maintained down to the landing screen height at a calibrated airspeed not less than V_{REF} with an approach path angle not exceeding the maximum for which approval is sought. (V_{REF} is the steady landing approach speed for a defined landing configuration.)

(iii) When an approved means of approach path visual guidance is used, and the approach path angle is equal to or greater than 4.5° , the landing screen height may be reduced to 35 feet.

NOTE: An operating limitation in the AFM should specify that when approach path visual guidance is not available, or the approach path angle is less than 4.5° , landing performance must be based on a screen height of 50 feet.

(4) In addition to the approach climb requirements of § 25.121(d) and the landing climb requirements of § 25.119, it must be possible to successfully complete a go-around in the landing configuration, with an engine failure at the Decision Height (DH) or Minimum Descent Altitude (MDA), as applicable. For propeller driven airplanes, the propeller of the inoperative engine should be in the position it automatically assumes following an engine failure.

(5) If the parametric method is used to determine landing distance, similar to paragraph 19b(3) of this AC, approach angles should be appropriate to the steep approach path angle desired, but the touchdown sink rate for data expansion should be limited to 6 feet per second.

d. Abuse Testing. Under no-wind conditions, it shall be demonstrated that it is possible to complete an approach, touchdown, and stop without displaying any hazardous characteristics in the following conditions:

(1) The recommended approach path angle $\pm 2^\circ$ at V_{REF} .

(2) The recommended approach path angle at V_{REF} minus 5 knots.

(3) For both conditions d(1) and d(2):

(i) The rate of descent must be reduced to less than 3 feet per second before touchdown.

(ii) Below a height of 200 ft, no action should be taken to increase power, apart from those small changes necessary to maintain an accurate approach.

(iii) The airplane should be loaded to the critical weight and c.g. combination, and the tests conducted in the all engines operating, or one-engine inoperative, short landing configuration, as appropriate.

(iv) During the $\pm 2^\circ$ approach path abuse demonstration, the engines must remain above idle when stabilized on the approach path.

NOTE: The approach angle abuse requirements are to account for tailwinds or headwinds on the approach and/or to account for necessary corrections back to the desired approach path after inadvertent excursions. The purpose of the

Section 6. STALLS

29. STALL TESTING.

a. The applicable Federal Aviation Regulations (FAR) are as follows:

Section 25.21(c)	Proof of Compliance
Section 25.103	Stalling Speed
Section 25.143	Controllability and Maneuverability (General)
Section 25.201	Stall Demonstration
Section 25.203	Stall Characteristics
Section 25.207	Stall Warning

b. Explanation.

- (1) The purpose of stall testing is threefold:
 - (i) To define the minimum inflight airspeeds and how they vary with weight, altitude, and airplane configuration (stall speeds).
 - (ii) To demonstrate that handling qualities are adequate to allow a safe recovery from the highest angle of attack attainable in normal flight (stall characteristics).
 - (iii) To determine that there is adequate pre-stall warning (either aerodynamic or artificial) to allow the pilot time to recover from any probable high angle of attack condition without inadvertently stalling the airplane.
- (2) During this testing, the angle of attack should be increased at least to the point where the following two conditions are satisfied:
 - (i) Attainment of an angle of attack measurably greater than that for maximum lift, except when the stall is defined by a stall identification device (e.g., stick pusher).
 - (ii) Clear indication to the pilot through the inherent flight characteristics or stall identification device (e.g., stick pusher) that the airplane is stalled.
- (3) The airplane is considered to be fully stalled when any one or a combination of the characteristics listed below occurs to give the pilot a clear and distinctive indication that he should stop any further increase in angle of attack, at which time recovery should be initiated using normal techniques. The stall speed is defined as the minimum speed reached during the maneuver, except for those airplanes that require stall identification devices (see paragraph 29b(3)(iv), below).
 - (i) The pitch control reaches the aft stop and is held full aft for two seconds, or until the pitch attitude stops increasing, whichever occurs later. In the case of turning flight stalls, recovery may be initiated once the pitch control reaches the aft stop when accompanied by a rolling motion that is not immediately controllable (provided the rolling motion complies with § 25.203(c)).
 - (ii) An uncommanded, distinctive and easily recognizable nose down pitch that cannot be readily arrested. This nose down pitch may be accompanied by a rolling motion that is not immediately controllable, provided that the rolling motion complies with § 25.203(b) or (c), as appropriate.
 - (iii) The airplane demonstrates an unmistakable, inherent aerodynamic warning of a magnitude and severity that is a strong and effective deterrent to further speed reduction. This deterrent level of aerodynamic

Flaps UP, Gear UP	FWD	Holding	Level, 40° banked turn Bank-to-bank rapid roll, 30° - 30° Speedbrake extension, retraction.
Flaps DN, Gear UP	FWD	Holding	Level, 40° banked turn Bank-to-bank rapid roll, 30° - 30° Speedbrake extension, retraction.
Landing	FWD	1.3 V _{S0} (i.e., V _{REF})	Level, 40° banked turn Bank-to-bank rapid roll, 30° - 30° Speedbrake extension, retraction.
Landing	FWD	Same as used for uncontaminated airplane stalls	Idle power 1 kt/sec decel to full stall

- (3) During any of the specified maneuvers, there should be no unusual control responses, or any uncommanded airplane motions. Additionally, during the level turns and bank-to-bank rolls, there should be no buffeting or stall warning.
- (4) It is acceptable for some ice to be shed during the flying qualities testing due to air loads, wing flexure, etc. However, an attempt should be made to accomplish the test maneuvers as soon as possible after exiting the icing cloud to minimize atmospheric influences on ice shedding.

233. CRITERIA FOR APPROVAL OF STEEP APPROACH TO LANDING.

- a. Applicable Regulations. Sections 25.119 & 25.125 of the Federal Aviation Regulations.
- b. Explanation.
 - (1) Sign Convention. In referring to approach path deviations/increments, a "plus" (or "+") indicates an increase in the approach path angle (i.e., steeper than) and a "minus" (or "-") indicates a decrease in the approach path angle (i.e., less steep).
 - (2) Airworthiness Approval. The standard approach angle certified as part of the type design of transport category airplanes for instrument landing operations is 3 degrees, which coincides with the nominal Instrument Landing System (ILS) approach angle. Some ILS installations use a 4.5 degree approach path angle, and a very small number exceed that angle under controlled conditions at dedicated Short Takeoff and Landing (STOL) facilities. Airplanes certified under 14 CFR part, with features that allow them to make steep approaches (greater than 4.5 degrees), and to take off and land in less than normal distances, have not been given credit for this capability by past FAA policies. In response to requests from several operators for authority to conduct steep approaches to short landing fields, the FAA has, however, developed the following basic airworthiness certification criteria for this type of approval. Additions or deletions to these criteria may be required to address specific design features. It should be noted in the Airplane Flight Manual (AFM) that the presentation of the steep approach limitations, procedures, and performance information reflects the capability of the airplane to perform steep approaches, but does not constitute operational approval.
 - (3) Operational Approval. Operational approval at a particular airport will, in part, be based on the results of the airworthiness testing described in this section. Additional testing, for operational concerns, may be combined with the airworthiness testing.
- c. General Requirements.

warning (i.e., buffed) must be of a much greater magnitude than the initial buffet ordinarily associated with stall warning. An example is a large transport airplane that exhibits "deletement buffet" with flaps up and is characterized by an intensity that inhibits reading cockpit instruments and would require a strong determined effort by the pilot to increase the angle of attack any further.

(iv) The activation point of a stall identification device that is a strong and effective deterrent to further speed reduction. Paragraph 228 of this AC presents guidance material for demonstrating compliance of stall identification systems with the regulatory requirements of Part 25 of the FAR.

NOTE: The regulatory requirements of § 25.201(d) define the stalled condition as occurring when the airplane has reached an angle of attack measurably greater than that for maximum lift. The related stall speed has been defined as the minimum speed obtained in the stalling maneuver (V_s , also referred to as V_{Smin}). This V_{Smin} definition has led to stall speeds sometimes being defined at excessively low load factors, with pilot objectivity and flying technique having considerable influence over the results. The subsequent effect on operating speeds can then lead to inconsistencies between similarly configured airplane designs and result in inadequate maneuver margins. Consequently, applicants are encouraged to use 1-g stall speeds that reflect the ability of the wing-generated lift to support the weight of the airplane in 1-g flight. These 1-g stall speeds may be used as the reference datum for regulatory compliance through an equivalent safety finding. The FAA is in the process of amending the stall speed requirements to incorporate the 1-g stall speed methodology (ref. NPRM 95-17). Upon adoption of the final 1-g stall speed rule, further revisions to the guidance material in this AC will be proposed. Details of the 1-g stall speed regulatory equivalences and the equivalent safety finding process are contained in Appendix 5.

(4) It should be recognized that the point at which the airplane is considered stalled may vary, depending on the airplane configuration (e.g., flaps, gear, center of gravity, and gross weight). In any case, the angle of attack must be increased until one or more of these characteristics is reached for all likely combinations of variables.

c. Stall Speeds.

(1) **Background.** Since many of the regulations pertaining to performance and handling qualities specify trim speeds and other variables that are functions of stall speeds, it is desirable to accomplish the stall speed testing early in the program, so the data are available for subsequent testing. Because of this interrelationship between the stall speeds and other critical performance parameters, it is essential that accurate measurement methods be used. Most standard airplane pilot-static systems have not been found to be acceptable for stall speed determination. These tests require the use of properly calibrated instruments and usually require a separate test airspeed system, such as a trailing boom, a trailing cone, or an acceptable nose or wing boom.

(2) Configuration.

(i) Stall speeds should be determined for all aerodynamic configurations to be certificated for use in the takeoff, en route, approach, and landing configurations.

(ii) The center of gravity positions to be used should be those that result in the highest stall speeds for each weight (forward e.g., in most cases).

(iii) Sufficient testing should be conducted to determine the effects of weight on stall speed. Altitude effects (compressibility, Reynolds Number) may also be considered if credit for variations in these parameters is sought by the applicant. If stall speeds are not to be defined as a function of altitude, then all stall speed testing should be conducted at a nominal altitude no lower than 1,500 ft. above the maximum approved takeoff and landing altitude. (See paragraph 29(c)(5)(vii) and Figures 29-3 and 29-4.)

(3) Procedures.

(i) The airplane should be trimmed for hands-off flight at a speed 20 percent to 40 percent above the anticipated stall speed, with the engines at idle and the airplane in the prescribed configuration for which the stall speed is being determined. Then, using only the primary longitudinal control, a constant deceleration (entry rate) is maintained until one of the previously defined points that define the stall is reached. Following the stall, engine thrust may be utilized, as desired, to expedite recovery.

(3) Stall testing should be conducted in stable, dry air with the artificial ice shapes installed. Effects of the ice shapes on stall speeds and controllability in the stalling maneuver should be determined. If the reference stall speeds (i.e., 1-g stall speeds as defined in Appendix 5) are increased by the greater of 3 percent or 3 knots, the approach and landing climb speeds, and landing reference speeds (V_{REF}) should be recalculated using those higher stall speeds. This will assure the retention of adequate stall margins.

(4) If landing reference speeds are increased to compensate for the effect of ice accretion on stall speeds, the landing distances should also be adjusted to reflect the effect of the increased landing speeds.

(5) Climb performance testing, with the artificial ice shapes installed, should be conducted in stable, dry air using the methods described in paragraph 17b (Ref: § 25.121) of this AC. The thrust setting for landing climb performance should be determined by the method described in paragraph 16b (Ref: § 25.119) of this AC for the critical air bleed configuration associated with operation of the ice protection system.

(6) The AFM approach and landing climb performance information must include performance decrements that account for the increased drag due to residual ice accretion and thrust (or power) loss due to operation of the ice protection system. For the landing climb of § 25.119, analytical methods may be employed for the derivation of the increase in drag due to ice accretion on the landing gear.

232. FLYING QUALITIES IN NATURAL ICING CONDITIONS.

a. Applicable Regulations. - Sections 25.143 and 25.1419 of the Federal Aviation Regulations (FAR).

b. Explanation.

(1) Since all aircraft will accumulate ice on unprotected surfaces with the ice protection system functioning normally, the effect of those ice accumulations on flying qualities should be determined. The flying qualities evaluation should include an investigation of the effects of any ice that may accumulate on the high lift devices (e.g., in slat or flap gaps, on flaps and associated structure, etc.). For airplanes with de-icing systems, consideration should also be given to the effects of any ice that would remain on the protected surfaces during normal system operation (this should also include Minimum Equipment List (MEL) dispatch considerations for all types of ice protection systems).

(2) To assure that there are no unusual or hazardous differences in handling characteristics between tests with artificial ice shapes and those associated with the critical natural ice buildup, an evaluation of airplane flying qualities should be performed following a natural icing encounter. The amount of ice on the airplane should be representative of what would be accumulated in a 45 minute hold in icing conditions prior to approach and landing (typically, one to two inches on the unprotected wing leading edge surfaces has been found acceptable for this testing).

(3) Based on the Failure Modes and Effects Analysis (FMEA) for the ice protection system, annunciations provided to the flightcrew, and recommended AFM procedures following a failure in the ice protection system, a handling qualities evaluation should be conducted with the appropriate amount of ice on the airplane in the appropriate locations. This failure condition handling qualities testing may be conducted with artificial ice shapes, rather than natural ice, if the applicant desires.

c. Procedures.

(1) Since extensive natural icing conditions are quite often difficult to find, applicants are encouraged to combine the flying qualities flight testing with other icing-related tests (e.g., ice shedding capability).

(2) The following flight tests were designed to evaluate maneuvers that can be expected while holding in icing conditions, and in the subsequent approach to landing. Additionally, one full stall should be conducted in the landing configuration.

CONFIGURATION CG TRIM SPEED MANEUVER

approach and landing climb gradients should maintain the same margins, relative to the increased maximum uphill runway slope, that exist between the minimum gradients specified in §§ 25.119 and 25.121 and a two percent uphill runway.

(4) **Landing Technique and Distance.** Final approaches to steep uphill runways will require early flare initiation, to avoid hard landings, and landing flare air distances will be increased for approaches to steep downhill runways using normal approach descent angles. The AFM operating procedures should describe any special piloting technique required for landing on steep runways. The AFM expansion of landing distances should account for the effect of runway gradient, including any expected increase in flare distances, from 50 feet to touchdown, for steep downhill runways.

(5) **Operating Procedures.** Operating procedures should be provided in the AFM for operations on runways with gradients greater than ± 2 percent. Guidance should be provided on takeoff rotation and landing flare techniques.

(6) **Operational Considerations.** For runway slopes greater than ± 3 percent, the specific airport(s) should be investigated relative to runway lengths and surrounding terrain and obstacles. Airport-specific operating limitations may be necessary, such as: direction of takeoff and landing, takeoff flap restrictions, prohibition of overspeed takeoffs on downhill runways, requirement for the antiskid system to be operative and on, and restrictions on engine bleed air and power extraction.

(7) **Flight Test Requirements.** For approval of certification data for runway slopes exceeding ± 3 percent, operational flight tests should be conducted to verify the proposed procedures and performance information.

231. PERFORMANCE REQUIREMENTS FOR FLIGHT IN ICING CONDITIONS.

a. **Applicable Regulations.** Sections 25.103, 25.117, 25.119, 25.121(c) and 25.1419 of the Federal Aviation Regulations (FAR).

b. **Explanation.**

(1) Section 25.117 of the FAR states that the climb requirements of §§ 25.119 and 25.121 must be complied with at each weight, altitude, and ambient temperature within the operational limits established for the airplane, and with the most unfavorable center of gravity for each configuration.

(2) When approval of an airplane for operation in known icing conditions is requested, compliance with the approach climb requirements of § 25.121(d), and landing climb requirements of § 25.119, should be demonstrated with residual ice accretions on unprotected areas of the airframe. For airplanes with de-ice systems, this would also include any ice not shed from protected surfaces with the system in its normal operating mode. The airplane is assumed to descend into, and be required to hold in, atmospheric conditions meeting the continuous maximum atmospheric icing conditions criteria described in Appendix C to Part 25 of the FAR. Approach and landing climb performance information, contained in the Airplane Flight Manual (AFM), should present the effects of residual airframe ice accretions and ice protection system operation.

c. **Procedures.**

(1) Artificial ice shapes should be constructed and installed for climb performance testing to be conducted in stable, dry air. The artificial ice shapes used for flight testing should be those that have the most adverse effect on handling characteristics. If it is determined that another reasonably expected ice shape could have a greater impact on performance, the artificial ice shape with the most adverse effect on handling characteristics may be used for performance flight testing, provided that any difference in performance can be conservatively taken into account.

(2) Appropriate artificial ice shapes should be determined by one or more of the following methods: natural atmospheric icing flight tests; flight behind an icing tanker; icing wind tunnel tests; or analytical prediction methods

(ii) A sufficient number of stalls (normally six) should be accomplished at each critical combination of weight, c.g., and external configuration, varying the entry rate from approximately 0.5 knots/second to 1.5 knots/second. The intent is to obtain enough data to define the stall speed at an entry rate of 1.0 knot/second. (See Figure 29-2.)

(iii) During the stall speed testing, the stall characteristics of the airplane must also satisfy the requirements of §§ 25.203(a) and (b).

(iv) For airplanes that have stall identification devices for which the angle of attack for activation is biased by angle of attack rate, some additional considerations are necessary. The stall speeds are normalized against an average airspeed deceleration rate, as described in paragraph 29c(5). However, stall identification systems generally activate at a specific angle of attack, biased by an instantaneous angle of attack rate. Therefore, longitudinal control manipulation by the pilot during the stall maneuver, close to the stall identification system activation point, can advance or delay its activation without appreciably affecting the average stall entry airspeed rate. To minimize scatter in the stall speed versus entry rate data, the pilot should attempt to maintain a stable angle of attack rate or pitch rate (not necessarily a fixed airspeed deceleration rate), until the stall identification system activates. The resulting time-history of angle of attack data should be smooth and without discontinuities. A cross plot of airspeed deceleration rate, as defined in paragraph 29c(5), versus angle of attack rate for all related test points, will show the general trend of this relationship for each flap setting. Any points that do not follow this general trend should not be used in establishing the stall speed.

(4) **Thrust Effects on Stall Speed.**

(i) Stall speeds are normally defined with the thrust levers at idle; however, it is necessary to verify by test or analysis that engine idle thrust does not affect stall speeds to an extent that they are appreciably lower than would be experienced at zero thrust. Negative thrust at the stall, which slightly increases stall speeds, is acceptable.

(ii) To determine whether thrust effects on stall speed are significant, at least three stalls should be conducted at one flap setting, with thrust set to approximately the value required to maintain level flight at 1.6 V_S in the selected configuration.

(iii) These data may then be extrapolated to a zero thrust condition to eliminate the effects of idle thrust on stall speeds (see Figure 29-5). If the difference between idle thrust and zero thrust stall speed is 0.5 knots or less, the effect may be considered insignificant.

(iv) The effects of engine power on stall speeds for a turbopropeller airplane can be evaluated in a similar manner. Stall speed flight tests should be accomplished with throttles closed and the propellers in the takeoff position. Engine torque, engine r.p.m., and estimated propeller efficiency can be used to predict the thrust associated with this configuration.

(5) **Data Reduction and Presentation.** The following is an example of how the data obtained during the stall speed testing may be reduced to standard conditions. Other methods have been found acceptable.

(i) Indicated airspeed from the flight test airspeed system is recorded throughout the stall, and these values are corrected to equivalent airspeed.

(ii) Stall entry rate is then defined as the slope of a straight line connecting stall speed and an airspeed 10 percent above the stall speed (see Figure 29-1).

$$\text{Entry Rate} = (V_S - 1.1 V_S) / \text{Time Difference}$$

(iii) The airplane lift coefficient, C_{L_s} , is then calculated for each test stall speed using the equation:

$$C_{L_s} = W/qS = 295.37(W)/(V_{S0}^2 S)$$

Where: W = airplane test weight - lbs.

q = dynamic pressure - lbs./ft.²
 S = reference wing area - ft.²
 $V_{S(e)}$ = test stall speed corrected to knots equivalent airspeed.

(iv) The C_L obtained for each stall is then corrected to the targeted c.g. position using the equation:

$$C_{L_{CG}} = C_L(1 + (MAC/h)(C_{G_{hd}} - C_{G_{ksl}}) - \Delta C_{L_T})$$

Where: MAC = Wing mean aerodynamic chord length - inches.

h = Effective tail length, measured between the wing 25 percent MAC and the horizontal stabilizer 25 percent MAC - inches.

$C_{G_{hd}}$ = Forward c.g. limit at the pertinent weight - percent MAC/100

$C_{G_{ksl}}$ = Actual test c.g. position - percent MAC/100

ΔC_{L_T} = Change in C_L due to engine thrust (if significant).

(v) For each targeted c.g. and external configuration, a plot of $C_{L_{CG}}$ versus entry rate is constructed. The final stall C_L is selected at an entry rate of 1.0 knot/second (see Figure 29-2).

(vi) For each final stall C_L , weight, wing flap, and external configuration, a plot of stall C_L versus weight is constructed (see Figure 29-3.) An initial negative slope of this plot may be caused by several factors:

(A) A decrease in $C_{L_{MAX}}$ due to increasing Mach number (which increases as the stall speed goes up with weight);

(B) The fact that $C_{L_{MAX}}$ is proportional to the rate of change of angle of attack, whereas the data are plotted at fixed airspeed bleed rate; and

(C) Minor adverse aerodynamic effects on the wings and high lift devices as weight (and therefore speed) increases. The inflection at the right end is caused typically by a less forward c.g. limit as weight increases.

(vii) In the measurement of stall speeds, the lowest test altitude is usually dictated by flight test safety concerns. This test data must then be expanded to lower altitudes, and hence lower Mach numbers, to cover the operational envelope of the airplane. Since $C_{L_{MAX}}$ increases as the Mach number is reduced, simple expansion of the flight test data could result in extrapolating to a higher $C_{L_{MAX}}$ than tested. Expansion of $C_{L_{MAX}}$ versus Mach number data is only permitted up to the highest $C_{L_{MAX}}$ within the range of W/δ^3 's tested.

(viii) Stalling speeds are then calculated using the equation:

$$V_{S(e)} = \sqrt{\frac{295.37(W)}{C_L(S)}}$$

Where: W = a series of weights chosen as the independent variable - lbs.

C_L = stall C_L corresponding to the chosen weight (see Figure 29-3).

S = reference wing area - ft.²

(ix) A plot of stall speed versus weight, showing each flap/gear configuration, is then constructed (see Figure 29-4).

limitations and operating procedures applied, these operations can also offer safety benefits. Three methods have been approved by the FAA for derated and reduced thrust takeoff operations. These methods are as follows:

(1) Derated thrust approvals entail the use of completely new takeoff power setting charts and Airplane Flight Manual (AFM) performance information. The new power settings are less than the engine manufacturer's approved takeoff thrust settings, and the AFM performance is based on the thrust developed at these new, lower thrust settings.

(2) A constant reduced thrust increment can be used for all operating conditions. In this method the engine parameter by which thrust is set is reduced by a constant, such as an engine pressure ratio increment (AEPR) of .02. A method is supplied to determine the airplane's takeoff performance, at this reduced thrust level, from the AFM data representative of full takeoff thrust.

(3) The assumed temperature method of reduced thrust takeoff operations entails using takeoff performance information determined for an "assumed" temperature above ambient, but not above the temperature at which the takeoff weight would be limited by the takeoff field length available for a particular airport runway or by FAA climb requirements. Engine thrust settings, takeoff speed schedules, takeoff field lengths, and climb performance are determined at the assumed temperature. This assumed temperature method is the most flexible in its application and the most widely used by transport category airplane manufacturers and operators.

b. **Procedures.** Because there is a reduction in the takeoff performance level when any of the derated or reduced thrust methods are used, the FAA has certain limitations on the use of these reduced thrust levels. The appropriate guidance for derated and reduced thrust approvals, including limitations and procedures, is presented in Advisory Circular 25-13, "Reduced and Derated Thrust (Power) Procedures," dated May 4, 1988.

230. RUNWAY GRADIENTS GREATER THAN +2 PERCENT.

a. **Applicable Regulations.** Sections 25.105, 25.115, 25.119, 25.121, 25.125, 25.1533 and 25.1587 of the Federal Aviation Regulations (FAR).

b. **Explanation.** The sections of Part 25 of the FAR, referenced above, require accounting for the effects of runway gradient. Typically, performance limitations and information are determined for runway gradients up to +2 percent in the Airplane Flight Manual (AFM) expansion of test data. Though these gradient extremes are adequate for addressing the majority of runways, there are a number of airports frequented by transport category airplanes that have runway slopes greater than +2 percent. Consequently, approvals have been granted for operations on runways with slopes exceeding ±2 percent with specific testing and analysis validation for the effects of the higher slopes. Additional concerns, beyond runway slope effect on acceleration and braking and proper accounting of elevations during obstacle clearance analysis, include takeoff flare from liftoff to 35 feet, minimum takeoff climb gradients, minimum approach and landing climb gradients, landing flare distances, and unique operating procedures.

c. Procedures.

(1) Takeoff Flare from Liftoff to 35 Feet. The AFM expansion of the takeoff data should account for the effect of the runway slope on the portion of the takeoff distance after liftoff. At climb performance-limiting thrust-to-weight ratios, the average gradient of climb will be on the order of 2.0 to 3.0 percent. On a downhill runway of sufficient magnitude, the airplane could attain a height of 35 feet above the runway and have a positive gradient of climb relative to it, but its flight path may continue to descend beyond that point. The transition from liftoff to climbing flight, in the sense of an ascending flight path, should be adequately addressed with respect to obstacle clearance analysis data.

(2) Minimum Takeoff Climb Gradients. At limiting thrust-to-weight ratios, the transition to free air (i.e., out of ground effect) takeoff climb could result in steep uphill runways rising faster than the airplane's ability to climb. The minimum second segment takeoff climb gradient should maintain the same margin, relative to the increased maximum uphill runway slope, that exists between the minimum gradient specified in § 25.121 and a two percent uphill runway.

(3) Minimum Approach and Landing Climb Gradients. Balked landing go-arounds, at climb limited landing weights, could also result in an uphill runway rising faster than the airplane's ability to climb. The minimum

d. Stall Characteristics.

(1) Background. Since operational pilots may not be required, or trained, to fly to an angle of attack beyond that for stall warning, any exposure to the behavior of the airplane in an actual stall would be both unexpected and unfamiliar. Therefore, to assure a safe and expeditious recovery from an unintentional stall, it should not require any unusual piloting technique to successfully demonstrate compliance with § 25.203, nor should it require exceptional skill or repeated practice by the test pilot. The behavior of the airplane during the stall and recovery must be easily controllable using normally expected pilot reactions.

(2) Configuration.

(i) Stall characteristics should be investigated with wings level and in a 30-degree banked turn, with both power on and power off in all configurations approved for normal operations.

(ii) The test configurations for stall characteristics should include deployed deceleration devices for all flap positions, unless limitations against the use of those devices with particular flap positions are imposed. 'Deceleration devices' include spoilers used as airbrakes, and thrust reversers approved for inflight use. Stall demonstrations with deceleration devices deployed should normally be carried out with power off, except where deployment of the deceleration devices with power on would likely occur in normal operations (e.g., extended spoilers during landing approach).

(iii) Stall characteristics should be investigated with any systems or devices that may alter the stalling behavior of the airplane in their normal functioning mode. Unless the design of the airplane's automatic flight control system precludes its ability to operate beyond the stall warning angle of attack, stall characteristics and the adequacy of stall warning should be evaluated when the airplane is stalled under the control of the automatic flight control system.

(iv) Power-off stalls should be conducted at flight idle for the appropriate configuration. For propeller-driven airplanes, the propeller should be set in the normal low pitch (high rpm.) position.

(v) For power-on stalls, thrust should be set to the value required to maintain level flight at a speed of 1.6 V_S with flaps in the approach position, landing gear retracted, and at maximum landing weight. The approach flap position referred to is the maximum flap deflection used to show compliance with § 25.121(d). Approach Climb.

(vi) Stall characteristics testing is normally done at the aft c.g. limit, which is typically the most adverse; however, if the stall speed tests at forward c.g. indicate that marginal stall recovery characteristics may exist at forward c.g., compliance with § 25.203 should be shown for the most critical loading.

(vii) Stalls must be demonstrated up to the maximum approved operating altitude to determine if there are any adverse compressibility effects on stall characteristics. These tests should be flown with gear and flaps up at the most adverse center of gravity. Thrust may be set, as required, to maintain approximately level flight and a 1 knot/second deceleration. A slight descent rate is permissible as long as the stall occurs at approximately the maximum approved altitude. Characteristics should be checked during a wings level stall and in a 30-degree banked turn.

(viii) For airplanes that are certificated for flight into known icing conditions, stall characteristics should be demonstrated with simulated ice shapes symmetrically attached to all surfaces that are not protected by anti-ice or de-icing systems. (For further guidance on approval for flight into known icing conditions, see paragraphs 231 and 232 of this AC.)

(ix) For abnormal aerodynamic configurations covered by AFM procedures, high angle of attack characteristics should be evaluated down to either stall warning, or to an angle of attack equivalent to the AFM recommended landing approach speed divided by 1.3. If adequate controllability is present at either of these conditions, it is not necessary to stall the airplane. "Adequate controllability" means that it is possible to produce and to correct pitch, roll, and yaw by unreversed use of the flight controls, and that there are no uncommanded airplane motions due to aerodynamic flow breakdown. If stall warning is used as the end point, then it should be

(2) Safety. Probability of artificial stall warning and stall identification systems operating inadvertently.

(i) The probability of inadvertent operation of artificial stall warning systems, during critical phases of flight, should not be greater than 10⁻⁵ per flight hour.

(ii) To ensure that inadvertent operation of the stall identification system does not jeopardize safe flight, and to maintain crew confidence in the system, it should be shown that:

(A) No single failure will result in inadvertent operation of the stall identification system; and

(B) The probability of inadvertent operation from all causes is improbable (not greater than 10⁻⁵ per flight hour).

(iii) Stall identification systems should be designed so that flight in turbulence will not result in inadvertent operation.

NOTE: In making the assessments of subparagraphs (iv), (v) and (vi), below, it should be assumed that in the climb, cruise, and descent flight regimes, corrective pilot action will not be initiated until three seconds after unwanted operation has been recognized. During takeoff and final approach, this time delay may be reduced to one second.

(iv) If inadvertent operation of the stall identification system would result in limit loads being exceeded in any part of the airplane structure, the probability of inadvertent operation must not be greater than 10⁻⁷ per flight hour.

(v) If inadvertent operation of the stall identification system would result in ultimate loads being exceeded in any part of the airplane structure, the probability of inadvertent operation must be extremely improbable (not greater than 10⁻⁹ per flight hour).

(vi) Inadvertent operation of the stall identification system should not cause catastrophic ground contact. This should be achieved by limiting the effect of the stall identification system to that necessary for stall identification purposes, without undue flight path deviation (e.g., by limiting the stroke of a stick pusher).

Alternatively, if inadvertent operation could result in catastrophic ground contact, the probability of inadvertent operation must be extremely improbable. Inhibition of the system close to the ground (e.g., for a fixed time after liftoff or below a radar altitude) would not normally be an acceptable means of compliance with this requirement.

f. System Functional Requirements.

(1) Operation of the stall identification system should reduce the airplane's angle of attack far enough below the point for its activation that inadvertent return to the stall angle of attack is unlikely.

(2) The characteristics of stall identification systems, which by design are intended to apply an abrupt nose-down control input (e.g., stick pushers), should be such that it is unlikely that a member of the flightcrew will prevent or delay their operation.

(3) Normal operation of the stall identification system should not result in the total normal acceleration of the airplane becoming negative.

(4) The longitudinal maneuvering capability of an airplane equipped with stall identification systems, at all speeds likely to be encountered in normal operations, should be substantially the same as would be expected for an airplane with acceptable aerodynamic stall characteristics.

229. REDUCED AND DERATED THRUST TAKEOFF OPERATIONS.

a. Explanation. The use of lowered and reduced thrust for takeoff operations can produce substantial reductions in operating costs due to lower fuel consumption and increased operating margins. With the appropriate

demonstrated that the airplane is safely controllable and maneuverable when flown at the recommended operating speed.

(x) Stall characteristics should also be demonstrated with the maximum allowable asymmetric fuel loading. Requirements are as specified in §§ 25.203(a) and (c).

(3) Procedures.

(i) The airplane should be trimmed for hands-off flight at a speed 20 percent to 40 percent above the stall speed, with the appropriate power setting and configuration. Then, using only the primary longitudinal control, establish and maintain a deceleration (entry rate) consistent with that specified in § 25.201(c)(1) or 25.201(c)(2), as appropriate, until the airplane is stalled. Both power and pilot selectable trim should remain constant throughout the stall and recovery (angle of attack has decreased to the point of no stall warning).

(ii) The same trim reference (for example, 1.3 V_S) should be used for both the stall speeds and characteristics testing. For all stall testing, the trim speed is based on the performance stall speeds that are (or will be) shown in the AFM.

(iii) During the approach to the stall, the longitudinal control pull force should increase continuously as speed is reduced from the trimmed speed to approximately 10 percent above the stall speed; below that speed some reduction in longitudinal control force is acceptable, provided it is not sudden or excessive.

(iv) Section 25.203(b) states that “the roll occurring between the stall and the completion of the recovery may not exceed approximately 20 degrees” for level wing stalls. In level wing stalls the bank angle may exceed 20 degrees occasionally, provided that lateral control is effective during recovery.

(v) Section 25.203(c) requires the action of the airplane, following the 30 degrees bank turning stalls, “not be so violent or extreme...” such that a prompt recovery would be difficult and require more than normal piloting skill. The maximum bank angle that occurs during the recovery should not exceed approximately 60 degrees in the original direction of the turn, or 30 degrees in the opposite direction.

(vi) The intent of evaluating the 3 knot per second deceleration rate required under § 25.201(c)(2) is to demonstrate safe characteristics at higher rates of increase in angle of attack than are obtained from the 1 knot per second stalls. The specified airspeed deceleration rate, and associated angle of attack rate, should be maintained up to the point at which the airplane stalls. The maximum bank angle that occurs during the recovery should not exceed approximately 90 degrees in the original direction of the turn, or 60 degrees in the opposite direction.

(vii) For those airplanes where stall is defined by full nose-up longitudinal control for both forward and aft c.g., the time at full aft stick during characteristics testing should be not less than that used for stall speed determination. For turning flight stalls, however, recovery may be initiated once the pitch control reaches the aft stop when accompanied by a rolling motion that is not immediately controllable (provided the rolling motion complies with § 25.203(c)).

(viii) Normal use of the lateral control must produce (or correct) a roll, and normal use of the directional control must produce (or correct) a yaw in the applied direction up to the point where the airplane is considered stalled. It must be possible to prevent or recover from a stall by normal use of the controls.

(ix) If wind tunnel tests have indicated an airplane may be susceptible to deep stall penetration (i.e., that area beyond the stall angle of attack from which recovery may be difficult or impossible), substantiation should be provided that there is adequate recovery control available at, and sufficiently beyond, the stall angle of attack.

e. (Reserved)

f. Stall Warning.

(1) Explanation. The purpose of these stall warning requirements is to provide an adequate spread between warning and stall to allow the pilot time to recover without inadvertently stalling the airplane.

(ii) Stall identification systems may incorporate automatic disarming in flight regimes where the risk of stalling is extremely remote or where their unwanted operation would pose a threat to continued safe flight; examples of such inhibitors would be high airspeed, and “g” cutouts (typically 0.5g), and while the pilot is following windshear recovery Flight Director guidance.

(iii) A means to quickly deactivate the stall identification system should be provided and be made readily available to the pilots. It should be effective at all times, and should be capable of preventing the system from making any input to the longitudinal control system. It should also be capable of canceling any input that has already been applied, from either normal operation or from a failure condition.

(iv) If a stall identification system is required to show compliance with the stall requirements of Part 25 in one (or some) airplane configuration(s), it does not have to be used for stall identification in configurations where compliance can be demonstrated without it. Unlike stall warning, the stall point, be it aerodynamic or artificially induced, represents an end-point outside the in-service operational envelope of the airplane, and, therefore, does not need to be provided by the same means for all flap and landing gear configurations. Additionally, the added system complexity, and increased exposure to malfunctions and failures, would not warrant the use of a stall identification system for configurations where it is not required.

d. Indicating and Warning Devices.

(1) A method should be provided to adequately ascertain the proper operation of the stall warning and stall identification systems prior to takeoff. This method should be described in the operating procedures section of the Airplane Flight Manual (AFM).

(2) Warning that the associated systems for operating the stall warning or stall identification devices has failed should be provided. As far as is practicable, this warning should cover all system failure modes.

(3) A clear and distinctive cockpit indication should be given when the stall identification system has been deactivated by the flightcrew (see paragraph 228c(2)(iii), above). This indication should be present as long as the system is deactivated.

(4) Any related limitations, and normal and emergency operating procedures, together with any information found necessary for safety during operation of the stall warning and identification systems, should be included in the AFM and supplemented by such markings and placards as deemed necessary.

e. System Reliability and Safety. When stall warning and/or stall identification systems are installed to show compliance with the stalling requirements of §§ 25.201, 25.203, and 25.207 of the FAR, engineering data must be supplied to satisfy the following criteria, determined in accordance with the procedures of Advisory Circular 25.1309-1A, “System Design Analysis,” dated June 21, 1988, where appropriate.

(1) Reliability. Probability of artificial stall warning and stall identification systems not operating when required:

(i) If stall warning is not clearly identifiable by natural characteristics, the loss of artificial stall warning must be improbable (not greater than 10^{-5} per flight hour). This reliability requirement is normally met by using dual, independent stall warning systems.

(ii) If the natural stall characteristics are unacceptable, the combination of failure of the stall identification system to operate and entry into a stall must be extremely improbable (not greater than 10^{-9} per flight hour). A stall identification system with a failure rate not greater than 10^{-4} per flight hour will satisfy this requirement.

(iii) If the natural stall characteristics are demonstrated to be benign, with the stall identification system disabled, a maximum failure rate of 10^{-3} per flight hour will be acceptable.

CHAPTER 8 - AIRWORTHINESS: MISCELLANEOUS ITEMS

228. DESIGN AND FUNCTION OF ARTIFICIAL STALL WARNING AND IDENTIFICATION SYSTEMS.

- a. Applicable Regulations. Sections 25.103, 25.201, 25.203, and 25.207 of the Federal Aviation Regulations (FAR).
- b. Explanation. Some airplanes require artificial stall warning systems, such as stick shakers, to compensate for a lack of clearly identifiable natural stall warnings to show compliance with the stall warning requirements of § 25.207. Similarly, some airplanes require a stall identification device or system (e.g., stick pusher, automatic inboard slat segment retraction, auto-trim, etc.) to compensate for an inability to meet the stalling definitions of § 25.201 or the stall characteristics requirements of § 25.203. In addition to compliance with the flight test requirements prescribed in Paragraph 29 of this AC, certain system design and function criteria should also be addressed during the certification process of these airplanes. Included are system arming and disarming, preflight checks, failure indications and warnings, and system reliability and safety. The reliability of these systems can be evaluated in terms of the probability of the system not operating when required, and the safety aspects in terms of the probability of the system operating inadvertently. The required reliability and safety of stall warning and identification systems should be defined as a function of how critical their respective functioning is to safety of flight.
- c. Arming and Disarming.
 - (1) Stall warning systems should be armed any time the airplane is in flight.
 - (i) Arming of stall warning systems has typically been accomplished by a ground/air logic circuit, which requires the nose and/or main gear squat switches to sense air mode before the system is armed. A pitch angle threshold during rotation has also been used to arm the stall warning system. These types of system arming schemes provide stall warning protection during liftoff and initial climb, where a stall would most probably have catastrophic consequences. They also provide protection against nuisance warnings during the takeoff roll, where the angle of attack (AOA) sensor vanes may be misaligned. Service history, however, has shown that systems armed around the liftoff point have caused pilots to abort takeoffs due to false alerts resulting from stall warning system faults or failures. In some cases, these high-energy rejected takeoffs have resulted in overruns. Therefore, system faults and failures that would lead to a false stall warning near liftoff should be made evident as early in the takeoff as practicable.
 - (ii) In accordance with the requirements of § 25.207(b), if a stall warning system is required for any normal combination of flap and landing gear position, it must be used for all combinations of flap and landing gear positions. The purpose of this requirement is to provide a standard, consistent warning to the flightcrew of an operational flight envelope limit.
 - (2) Stall identification systems should be armed any time the airplane is in flight.
 - (i) The arming should take place automatically and may be provided by the same ground/air sensing system used for arming the stall warning system. The stall identification system may be inhibited during the takeoff rotation, but should become functional immediately after main gear liftoff. For airplanes with both stall warning and stall identification systems, it is permissible to have the stall identification system armed by operation of the stall warning system, provided the resulting probability of the stall identification not to operate when required is not greater than that specified in paragraph 228e, below.

(2) Background. To be acceptable, a stall warning must have the following features:

- (i) Distinctiveness. The stall warning indication must be clear and distinct to a degree that will ensure positive pilot recognition of an impending stall.
 - (ii) Timeliness. The stall warning should normally begin at a speed not less than 7 percent above the stall speed. A lesser margin may be acceptable, depending on the probability of an inadvertent stall following stall warning recognition, and how much difference there is between the speed at which the airplane stalls (stall identification), and the minimum speed allowed under § 25.103(a).
 - (iii) Consistency. The stall warning must be reliable and repeatable. The warning must occur with flaps and gear in all normally used positions in both straight and turning flight. The warning may be furnished naturally through the inherent aerodynamic characteristics of the airplane, or artificially by a system designed for this purpose. If artificial stall warning is provided for any airplane configuration, it must be provided for all configurations, and continue throughout the stall until the angle of attack is reduced to approximately that at which stall warning was initiated.
 - (iv) An artificial stall warning indication that is a solely visual device which requires attention in the cockpit, inhibits cockpit conversation or, in the event of malfunction, causes distraction that would interfere with safe operation of the airplane, is not acceptable.
 - (v) For airplanes that use artificial stall warning systems, paragraph 228 of this AC presents guidance material for demonstrating compliance with the regulatory requirements of Part 25 of the FAR.
- (3) Procedures. Stall warning tests are normally conducted in conjunction with the stall testing required by §§ 25.103 (stall speeds) and 25.203 (stall characteristics).
 - (4) Data Acquisition and Reduction. The stall warning speed and type and quality of warning should be noted. The speed at which acceptable stall warning begins should then be compared to the stall speed as defined in paragraph (3) above to determine if the required margin exists.
 - g. Accelerated Stall Warning. The applicant should determine that adequate stall warning occurs in turning flight under expected conditions of flight for takeoff, en route, and approach/landing configurations at aft c.g. and heavy weight. It should be demonstrated in slow-down turns at 1.5g normal load factor, with entry rates of at least 2 knots per second, that sufficient stall warning is provided to prevent stalling when the pilot takes recovery action not less than one second after recognition of stall warning. When stall warning is provided by an artificial system, that system's activation point should be set to the high side of its angle of attack tolerance band for this testing.
 - h. Maneuver Margins. The applicant should determine that adequate maneuvering capability exists prior to stall warning at V_2 , all-engines-operating takeoff speed (typically defined as V_{2+XX} kts.), final takeoff speed (§ 25.121(c)), and V_{REF} at forward c.g. and heavy weight for each appropriate flap setting. When stall warning is provided by an artificial system, that system's activation point should be set to the low side of its angle of attack tolerance band for this testing.
- NOTE:** If it can be shown that the angle of attack tolerance band of an artificial stall warning system results in no more than a ± 1.0 knot variation about the stall warning speed obtained at the nominal AOA setting, that nominal setting may be used for the maneuver margin testing specified in paragraph 29h, above.
- i. Reliability of Artificial Stall Warning and Stall Identification Systems. Guidance material related to the testing and approval of artificial stall warning and stall identification systems is presented in paragraph 228 of this AC.

FIGURE 29-1. STALL TEST TIME HISTORY

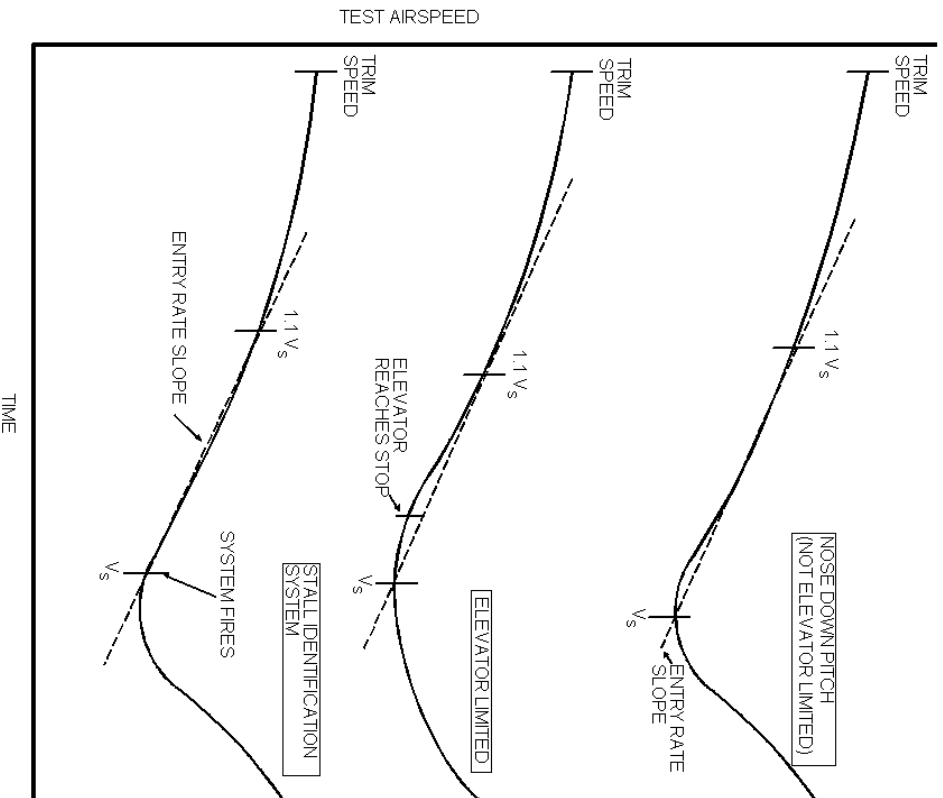

FIGURE 29-2. STALL G_{CG} vs ENTRY RATE

CHAPTER 7 - OPERATING LIMITATIONS AND INFORMATION.

Section 1. GENERAL [RESERVED]

Section 2. OPERATING LIMITATIONS [RESERVED]

Section 3. MARKINGS AND PLACARDS [RESERVED]

Section 4. AIRPLANE FLIGHT MANUAL

224. GENERAL - § 25.1581.

a. Explanation. The primary purpose of the FAA approved Airplane Flight Manual (AFM) is to provide an authoritative source of information considered to be necessary for safe operation of the airplane. Since the flightcrew is most directly concerned with operation of the airplane, the language and presentation of the flight manual should be directed principally to the needs and convenience of the flightcrew, but should not ignore the needs of other contributors to safe operation of the airplane in accordance with the applicable operating regulations.

(1) Section 25.1501 requires that the operating limitations specified in §§ 25.1503 through 25.1533, and other information necessary for safe operation, be included in the AFM, be expressed in markings and placards, and also be made available by any other means that will convey the necessary information to the crew members.

(2) Information and data that are mandatory for an acceptable AFM are prescribed in §§ 25.1581 through 25.1587. The material required by Parts 25 and 36 of the FAR must be included in the AFM. At the option of the applicant, the AFM may be expanded to contain additional FAA approved information.

(3) The manufacturer or operator may include other "unapproved" data in a separate and distinctively identified portion of the AFM.

b. Reference. See Advisory Circular 25.1581, "Airplane Flight Manual," dated July 14, 1997, for detailed guidance on the required content and general structure of the AFM.

[225. - 227.] [RESERVED]

Section 6. MISCELLANEOUS EQUIPMENT

208. ELECTRONIC EQUIPMENT - § 25.1431.

a. Explanation. The possibility of interaction between two systems of communications and navigation equipment should be evaluated. Momentary deflection or flicker should be permitted. (Flicker frequencies above 55 Hz for stroke symbology or non-interlaced raster and 30/60 Hz for interlaced raster are generally satisfactory.) Loss of required function of the usable and assigned frequencies in the national airspace system should be considered unacceptable.

b. Procedures. None.

[209. - 223.] [RESERVED]

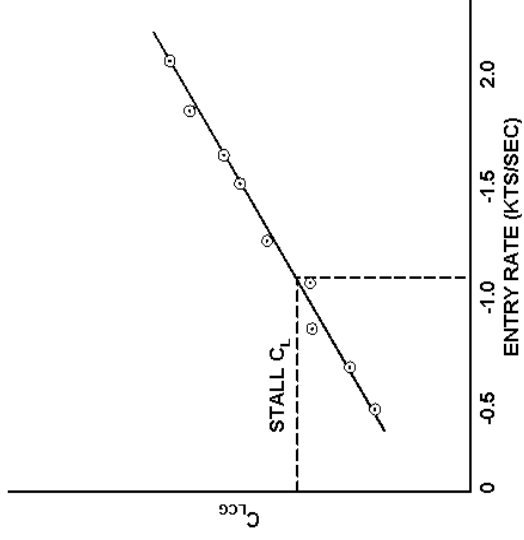

FIGURE 29-3. STALL C_L vs WEIGHT AND FLAP SETTING

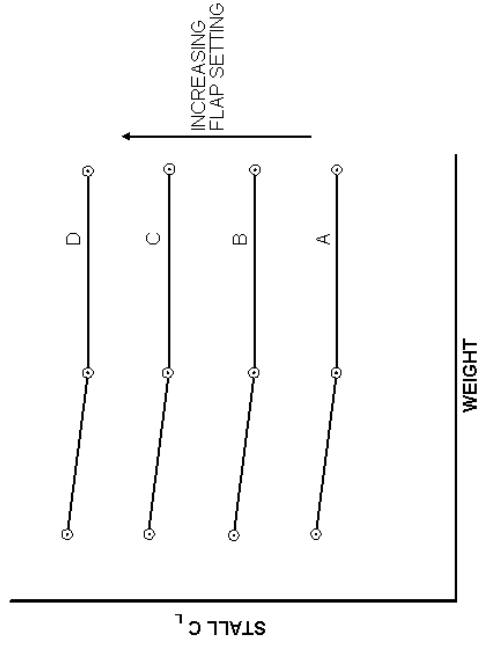

FIGURE 29-4. STALL SPEEDS vs WEIGHT AND FLAP SETTING

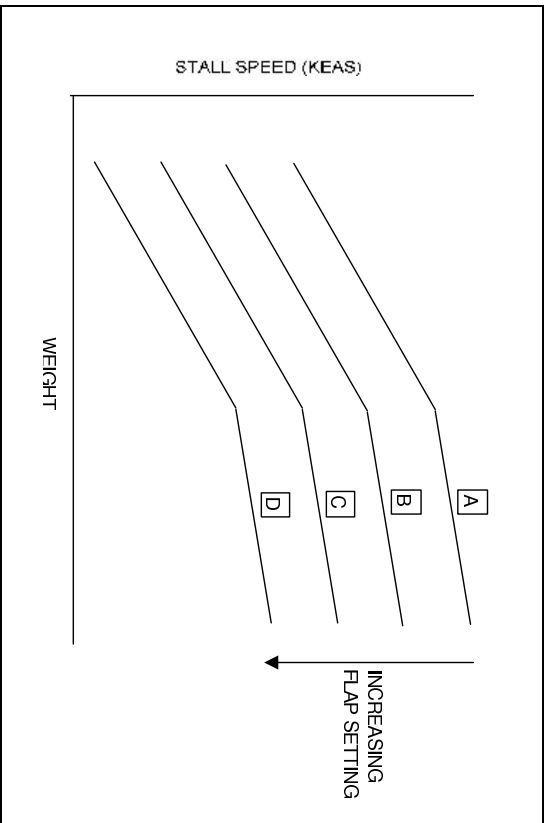
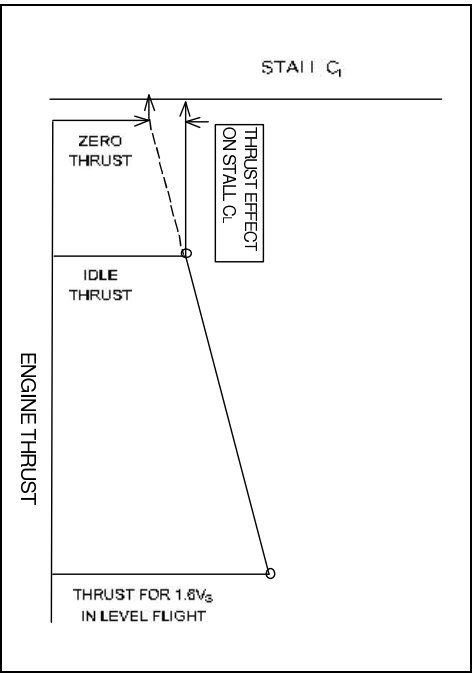

FIGURE 29-5. THRUST EFFECT ON STALL C_L



(2) Verify that position light illumination does not cause objectionable glare to the flightcrew.

[194, - 200.] [RESERVED]

201. ANTICOLLISION LIGHT SYSTEM - § 25.1401

a. Explanation. Section 25.1401(a)(2) requires the anti-collision light system to comply with the detailed specifications contained in §§ 25.1401(b) through (f). These sections define coverage, color, flash rate, and intensity requirements with some precision. An in-depth examination of the installed anti-collision system, with regard to all of these requirements, is not necessarily considered appropriate or within the scope of a flight test evaluation, unless it becomes apparent while accomplishing the following procedures that further examination is warranted.

b. Procedure.

(1) Operate the anti-collision light system. Verify that one or more red or white lights are installed in locations that appear to provide the required visibility and which flash at the appropriate rates.

(2) Verify that the anti-collision lights do not cause objectionable glare to the flightcrew.

(4) Evaluate anti-collision lights during flight in clouds.

202. WING ICING DETECTION LIGHTS - § 25.1403.

a. Explanation. If the airplane is intended to be certificated for night flight into known icing conditions, a means for visually or otherwise determining the extent of icing on critical surfaces must be provided.

b. Procedure. The wing icing detection lights, if required, should be evaluated to determine that they:

(1) Are aimed properly toward the appropriate surfaces, and are of sufficient intensity for required illumination.

(2) Are not a source of objectionable glare, reflection, or halation.

Section 7. GROUND AND WATER HANDLING CHARACTERISTICS

30. GENERAL.

a. Applicable Federal Aviation Regulations (FAR). The applicable regulations are §§ 25.231, 25.233, 25.235, 25.237, and 25.239 of the FAR.

b. Section 25.231 - Longitudinal Stability and Control.

(1) Explanation. Test program objectives would not be expected to demonstrate taxing over rough surfaces at speeds high enough to approach structural design limits, nor is it expected that in the test program the airplane be landed harder or at higher sink rates than it will ever encounter in service. However, new or modified landing gear systems should be evaluated on rough surfaces that are representative of normal service, and landings should be conducted at various sink rates sufficient to identify any dangerous characteristics or tendencies. Variables to be considered are center of gravity and taxi speed. The cockpit motion dynamics during ground handling should not impede control of the airplane, and pitching motion during bounce should not create static pitch control problems or pilot induced oscillation tendencies.

(2) Procedures. Ground handling tests at speeds normally expected in service should be conducted on smooth and rough surfaces that are likely to be encountered under normal operating conditions. Particular attention should be paid to the following:

(i) Brakes. The adequacy of the brakes when maneuvering on the ground and the tendency of the brakes to cause nosing-over should be investigated. Any bad tendency will normally be exaggerated when taxiing in a strong cross or tailwind.

(ii) Seaplanes and Amphibians. The most adverse water conditions safe for taxiing, takeoff, and landing must be established. The use and limitations of reverse thrust must be determined.

c. Section 25.233 - Directional Stability and Control.

(1) Explanation. None.

(2) Procedures. Taxi, takeoff, and landing should be conducted in all configurations under normal operating conditions.

(i) There may be no uncontrollable ground-looping tendency in 90-degree crosswinds, up to a wind velocity of 20 knots or $0.2V_{SO}$, whichever is greater (except that the wind velocity need not exceed 25 knots) at any speed at which the airplane may be expected to be operated on the ground. This may be shown while establishing the 90-degree crosswind component required by § 25.237.

(ii) Landplanes must be satisfactorily controllable, without exceptional piloting skill or alertness in power-off landings at normal landing speed, without using brakes or engine

power to maintain a straight path. This may be shown during power-off landings made in conjunction with other tests.

Section 4. LIGHTS

(iii) The airplane must have adequate directional control during taxiing. This may be shown during taxiing prior to takeoffs made in conjunction with other tests.

d. Section 25.235 - Taxiing Condition [RESERVED]

e. Section 25.237 - Wind Velocities.

(1) Explanation

(i) Landplanes.

(A) There must be a 90-degree crosswind component established that is shown to be safe for takeoff and landing on dry runways.

(B) The airplane must exhibit satisfactory controllability and handling characteristics in 90-degree crosswinds at any ground speed at which the airplane is expected to operate.

(ii) Seaplanes and Amphibians.

(A) There must be a 90-degree crosswind component established that is shown to be safe for takeoff and landing in all water conditions that may reasonably be expected in normal operation.

(B) There must be a wind velocity established for which taxiing is safe in any direction under all water conditions that may reasonably be expected in normal operation.

(iii) Crosswind Demonstration. A 90-degree crosswind component at 10 meters (as required by § 25.21(d)) of at least 20 knots or 0.2 V_{SO} (where V_{SO} is for the maximum design landing weight), whichever is greater, except that it need not exceed 25 knots, must be demonstrated during type certification tests. There are two results possible:

(A) A crosswind component value may be established that meets the minimum requirements but is not considered to be a limiting value for airplane handling characteristics. This "demonstrated" value should be included as information in the AFM.

(B) A crosswind component value may be established that is considered to be a maximum limiting value up to which it is safe to operate for takeoff and landing. This "limiting" value should be shown in the operating limitations section of the AFM.

(2) Procedures.

(i) Configuration. These tests should be conducted in the following configurations:

191. INSTRUMENT LIGHTS - § 25.1381.

a. Explanation None.

b. Procedure. Under actual or simulated nighttime conditions, evaluate instrument lighting for the following characteristics:

(1) Illumination of adequate intensity is provided for all appropriate cockpit instruments/controls/equipment.

(2) Illumination is of appropriate color, intensity is evenly distributed, and is free of objectionable flicker, glare, or reflection.

(3) Dimming capability allows smoothly adjustable illumination intensity between appropriate limits.

192. LANDING LIGHTS - § 25.1383.

a. Explanation None

b. Procedure. The landing gear lights should be evaluated to determine that they:

(1) Are aimed properly, provide sufficient intensity to facilitate night landings, and are acceptable at different pitch attitudes during landing approach with various c.g., flap settings and airspeed;

(2) Are not a source of objectionable glare or halation;

(3) Are functional in MMEL configurations and during operations in adverse weather.

193. POSITION LIGHT SYSTEM INSTALLATION - § 25.1385.

a. Explanation. Section 25.1385(a) requires the position light system to comply with detailed technical specifications contained in §§ 25.1387 through 25.1397. These sections define location, color, visibility, and intensity requirements with considerable precision. An in-depth examination of the installed position light system with regard to these requirements is not necessarily considered appropriate or within the scope of a flight test evaluation, unless it becomes apparent while accomplishing the following procedures that further examination is warranted.

b. Procedures.

(1) Operate the position light system. Verify that general locations and color are as prescribed in §§ 25.1385(b) and (c).

189. CIRCUIT PROTECTIVE DEVICES - § 25.1357. [RESERVED]

190. ELECTRICAL SYSTEM TESTS - § 25.1363.

a. Explanation. Laboratory tests are conducted to verify that the control, regulation, protection, and automatic operation of the electrical system comply with §§ 25.1351 through 25.1357. Laboratory tests must be conducted on a mockup using the same type and length of feeder wires, and generating equipment, that will be installed in the airplane. Additionally, the generator drives must simulate the actual prime movers on the airplane with respect to their reaction to generator loading, including loading due to faults. Section 25.1363(b) states that for each flight condition that cannot be adequately simulated in the laboratory or by ground tests on the airplane, a flight test must be conducted.

b. Procedures. Negative Acceleration Performance - Verify that no hazardous malfunctions of the electrical power system occur when the airplane is operated at the negative accelerations within the flight envelope prescribed in § 25.333. This must be shown for the greatest duration expected for the acceleration. This test is normally conducted in conjunction with the engine negative acceleration test to comply with § 25.943.

(A) At light weight and aft c.g. (this is desirable; however, flexibility should be permitted).

(B) Normal takeoff and landing flap configurations using the recommended procedures.

(C) Normal usage of thrust reversers. Particular attention should be paid to any degradation of rudder effectiveness due to thrust reverser airflow effects.

(D) Yaw dampers/turn coordinator On, or Off, whichever is applicable.

(ii) Test Procedure and Required Data. Three takeoffs and 3 landings, with at least one landing to a full stop, should be conducted in a 90-degree crosswind component of at least 20 knots or $0.2V_{SO}$, whichever is greater, except that for airplanes whose certification basis includes Amendment 25-42, it need not exceed 25 knots. For each test condition, a qualitative evaluation by the pilot of airplane control capability, forces, airplane dynamic reaction in gusty crosswinds (if available), and general handling characteristics should be conducted. The airplane must be satisfactorily controllable without requiring exceptional piloting skill or strength. Wind data from Inertial Navigation Systems (INS), tower, or portable ground recording stations should be corrected to a 90-degree crosswind component and to a height of 10 meters.

f. Section 25.239 - Spray Characteristics, Control, and Stability on Water.

(1) Explanation. These characteristics should be investigated at the most adverse weight/c.g. combinations.

(2) Procedures.

(i) The spray characteristics and, in particular, the pilot view during the initial takeoff run, should allow sufficient view in order to maintain a reasonable track over the water. Since not all seaplane operations are on open lakes or bays, but can be on rivers or channels, the directional control and view should be sufficient enough to stay within the channel confines.

(ii) The tendency of the wing floats or sponsons to submerge and/or cause waterloops should be evaluated during the crosswind testing. During the step taxiing evaluations, the floats should also be evaluated for any tendency to bury and either cause waterlooping or damage. The procedures used to avoid undesirable characteristics should be included in the AFM.

(iii) During low speed taxi, the effectiveness of the water rudders and/or asymmetric thrust should be evaluated in view of the types of maneuvering to be expected in service. If reverse thrust is to be used, it too should be evaluated in terms of ease of accomplishment and crew coordination.

(iv) If an amphibian is intended to be "beached" or run up a ramp, the handling characteristics and ability to maneuver onto the ramp should be evaluated. Forward c.g. is generally more critical. The procedures should be included in the AFM. There should be no undue tendency to damage the bow or other structure.

- (v) Engine failure of the critical engine at any time during the takeoff run should be evaluated. No dangerous porpoising, swerving, or waterlooping should result.
- (vi) There should be no undue tendency to porpoise and no extraordinary skill or alertness should be required to control porpoising.
- (vii) Spray impingement on the airframe (control surfaces, etc.) should be evaluated to assure the resulting loads are within acceptable limits.
- (viii) The above evaluations should be performed in the airplane on the water rather than by analysis or model testing. Analysis and/or model testing may be used to point out the problem areas but should not be substituted for actual testing.

- (ii) During a flight of maximum duration; and
- (iii) Under the most adverse cooling condition likely to occur in service.

(4) Section 25.1353(c)(2) - Compliance with § 25.1353(c)(1). Compliance with § 25.1353(c)(1), above, must be shown by test, unless experience with similar batteries and installations has shown that maintaining safe cell temperatures and pressures is not a problem.

(5) Section 25.1353(c)(3) - Storage Battery Gases. Verify by design analysis, laboratory demonstration, or airplane functional tests that no explosive or toxic gases emitted by any battery in normal operation, or as a result of any probable malfunction in the charging system or battery installation, accumulate in hazardous quantities within the airplane.

(6) Section 25.1353(c)(4) - Equipment Adjacent to Storage Batteries. Verify by design review that no corrosive fluids or gases that may escape from the battery may damage surrounding airplane structures or adjacent essential equipment.

(7) Section 25.1353(c)(5) - Storage Battery Heat. Verify by design analysis, or laboratory demonstration, that each nickel-cadmium battery installation, has provisions to prevent any hazardous effect on structure or essential systems that may be caused by the maximum amount of heat the battery can generate during a short circuit of the battery or its individual cells.

(8) Section 25.1353(c)(6) - Storage Batteries Used for Engine Start. Verify by design analysis, laboratory demonstration, or airplane functional tests that any nickel-cadmium battery installation capable of being used to start an engine or auxiliary power unit has one or more of the following:

- (i) A system to control the charging rate of the battery automatically to prevent battery overheating;
- (ii) A battery temperature sensing and over-temperature warning system with a means for disconnecting the battery from its charging source in the event of an over-temperature condition; or
- (iii) A battery failure sensing and warning system with a means for disconnecting the battery from its charging source in the event of battery failure.

188. DISTRIBUTION SYSTEM - § 25.1355.

a. Explanation. Section 25.1355(a) defines the distribution system, including the distribution busses, their associated feeders, and each control and protective device.

b. Procedures. Section 25.1355(c) - Independent Power Sources. For equipment or systems that are required to have two independent sources of electrical power, verify by airplane demonstration that in the event of a failure of one power source for such equipment or system, another power source (including its separate feeder) is automatically provided or can be manually selected to maintain equipment or system operation.

Section 8. MISCELLANEOUS FLIGHT REQUIREMENTS

31. VIBRATION AND BUFFETING - § 25.251.

a. Explanation.

(1) The testing required by Subpart C of Part 25 covers the vibration extremes expected in service. The applicant's flight tests should assure that the regulatory limits are not exceeded. Flight testing should not be conducted beyond where structural (Subpart C) tests and calculations have been completed.

(2) For §§ 25.251(b) and (c), vibration and buffeting is considered excessive when it is determined that it:

- (i) May cause structural damage or, if sustained over an extended period of time, could lead to structural fatigue;
- (ii) May cause pilot fatigue or annoyance that interferes with operation of the airplane or management of the airplane systems; or,
- (iii) Interferes with flight instrument readability.

(3) No perceptible buffeting is permitted in the cruise configuration as required by § 25.251(d). Weight and/or altitude Airplane Flight Manual (AFM) limitations may need to be imposed to comply with this criterion. Reasonable buffeting during the deployment of spoilers and other high drag devices is permitted to the extent allowed under §§ 25.251(b) and (c), as described in paragraph (2) above.

(4) A determination of a buffet onset envelope is to be established for the ranges of airspeed and/or Mach number, weight, altitude, and load factor for which the airplane is to be certificated. This envelope should be made a part of the AFM in accordance with § 25.1585(c). These AFM data should be valid criteria for forward c.g. conditions or correctable to forward c.g. by the use of AFM procedures. This boundary should be established by pilot event, as there is no established criterion for buffet level at the pilot station. A normal acceleration of $\pm 0.5g$ has been proposed; however, that will vary from airplane to airplane and may also be affected by the dynamic response of the accelerometer.

(5) Modifications to airplanes, particularly modifications that may affect airflow about the wing, should be evaluated for their effect on vibration and buffeting characteristics, changes in the speeds for onset of buffet, and maneuvering characteristics beyond buffet onset. This change may not only impact the buffet boundary envelope, but may change the acceptability of the V_{MO}/M_{MO} or V_{Df}/M_{Df} derived from the unmodified airplane. If this occurs, the maximum operating speed and dive speed may be reduced. However, the applicable speed spread margin regulations remain in effect. Systems and flight characteristics affected by the reduced maximum speeds should also be reevaluated. Indicator markings, overspeed horns, etc. should be reset, as necessary, if the airplane is to remain in the transport category.

(6) On swept-wing airplanes, undesirable pitch-up maneuvering characteristics can occur as the center of lift moves inboard and forward with increasing g, due to shock-wave induced separation and/or as wing load alleviation systems unload the wingtips. Straight-wing airplanes can also exhibit similar characteristics; therefore, new airplanes and those modified in a manner that may affect the spanwise lift distribution or produce undesirable pitching moment as a function of g, or increase the exposure to high altitude buffet encounters, should be evaluated as described herein.

(7) It has been determined that a positive slope of the stick force versus g ($F_{S/g}$) relationship is not necessarily required at speeds and g combinations beyond V_{FC}/M_{FC} and/or buffet onset. However, § 25.251(e) requires that "probable inadvertent excursions beyond the boundaries of buffet" may not result in "unsafe conditions." In order to assure that no "unsafe conditions" are encountered in maneuvering flight, maneuvering flight evaluations to demonstrate satisfactory maneuvering stability are described herein. A determination of the longitudinal maneuvering characteristics should be made to assure the airplane is safely controllable and

(A) Thirty (30)-Minute Requirement Test. Accomplish ground and/or flight testing to verify that the main battery/non time-limited power source (e.g., auxiliary power unit (APU), ram air turbine, pneumatic or hydraulic motor, etc.) is sufficient to power the essential loads required for safety of flight during IMC operations for at least 30 minutes. If the emergency power is provided by a non time-limited power source, the main battery capacity should be sufficient for at least 5 minutes to show compliance with § 25.1351(d). Essential loads for safety of flight during IMC operations are considered to include the following:

- (1) Those essential for continued safe flight and landing during Visual Meteorological Conditions (VMC) operations.
- (2) One display of attitude, direction, airspeed and altitude as specifically stated in § 25.1333(b), a free-air temperature indicator, and pitot/static heat capability, if required.
- (3) Communication, intercommunication, and navigation capability (for IMC operations) necessary cockpit and instrument lighting, and any other instrument displays, systems, equipment, or parts of the airplane that are necessary to safely complete the flight.

(B) Perform a VMC approach and landing with the airplane powered with emergency electrical power only. Verify acceptable operation of the emergency equipment.

(C) Perform a simulated night IMC approach and landing with the airplane powered with emergency electrical power only. Verify acceptable visibility and operation of the emergency equipment. This test can be accomplished on a simulator.

(ii) (Time-Limited Emergency Electrical Power Supply.) [RESERVED]

187. ELECTRICAL EQUIPMENT AND INSTALLATIONS - § 25.1353.

a. Explanation. None.

b. Procedures.

(1) Section 25.1353(a) - Equipment Interference. Verify by design analysis, laboratory demonstration, or airplane functional tests that the operation of each electrical unit, or system of units, will not adversely affect simultaneous operation of any other unit or system essential to the safe operation of the airplane.

(2) [RESERVED]

(3) Section 25.1353(c)(1) - Storage Batteries. Verify, for all storage batteries, that during any probable charging and discharging condition, including when the battery is recharged after previous complete discharge, the cell temperatures and pressures of the batteries are safely maintained:

- (i) During maximum regulated voltage or power;

maneuverable in the cruise configuration to assure there is no danger of exceeding the airplane limit load factor; and that the airplane's pitch response to primary longitudinal control is predictable to the pilot.

b. Procedures.

(1) Section 25.251(a). The test procedures outlined below will provide the necessary flight demonstrations for compliance with § 25.251(a).

(2) Section 25.251(b). The airplane should be flown at V_{Df}/M_{Df} at several altitudes from the highest practicable cruise altitude to the lowest practicable altitude. The test should be flown starting from trimmed flight at V_{MO}/M_{MO} at a thrust setting not exceeding maximum continuous power. The airplane gross weight should be as high as practicable for the cruise condition, with the c.g. at or near the forward limit.

(i) Flight drag devices should also be deployed at V_{Df}/M_{Df} (spoilers and speed brakes); thrust reversers, if designed for inflight deployment, should be deployed at their limit speed conditions.

(ii) Airplanes equipped with pneumatic de-icer boots should be evaluated to V_{MO}/M_{MO} with de-icing on and off (if automatic) and not operating. If the applicant desires to restrict the maximum operating speed (V_{MO}/M_{MO}) to a lower value with de-icing on, it should be shown that excessive vibration or buffeting does not occur at speeds of the new V_{MO}/M_{MO} plus the speed spread (V_{MO}/M_{MO} to V_{Df}/M_{Df}) determined with anti-icing off.

(3) Section 25.251(c). The weight of the airplane should be as heavy as practical, commensurate with achieving the maximum certificated altitude.

(4) Section 25.251(d). It should be demonstrated in flight tests that perceptible buffeting does not occur in straight flight in the cruise configuration, at any speed up to V_{MO}/M_{MO} to show compliance with § 25.251(d). This should be met from initial combinations of critical weight and altitude, if achievable, where the airplane has a 0.3g margin to the buffet onset boundary developed under § 25.251(e). These initial conditions should be established using a nominal cruise Mach number (typically long-range cruise Mach, M_{LRC}) with the c.g. at the forward limit. This flight condition is representative of practical operating criteria imposed by most operators. From these initial conditions, the airplane should be accelerated in 1.0g flight to V_{MO}/M_{MO} using maximum continuous thrust. Descending flight is acceptable if needed to achieve V_{MO}/M_{MO} .

(5) Section 25.251(e). Section 25.251(e) requires the determination of the buffet onset envelope, in the cruise configuration, for airplanes with MD greater than 0.6 or maximum operating altitudes greater than 25,000 feet. This requirement also provides criteria for evaluation of maneuvering stability in cruise flight under load factor conditions up to and beyond the onset of buffet.

(i) The determination of compliance with § 25.251(e), using flight test data from maneuvers conducted well into buffet, is extremely difficult due to the dynamics of this type of maneuver and the establishment of the F_s/g relationship from such data. The pilot flying the airplane needs to evaluate the airplane characteristics under such conditions. In this regard, Figures 31-1 and 31-2 illustrate general airplane responses and do not necessarily indicate required quantitative flight test results.

(A) Airplanes should be evaluated at the most aft c.g. in accordance with the following criteria:

(1) For all weight/altitude combinations where buffet onset occurs at various load factors between approximately +1g and +2g, the longitudinal control force (F_s) characteristics of §§ 25.255(b)(1) and (2) apply prior to encountering that buffet onset (see buffet free regions of Figures 31-1 and 31-2).

(2) Under the airplane weight/altitude/speed combinations of (1), above, but at load factors beyond buffet onset, the following F_s characteristics apply (see buffet regions of Figures 31-1 and 31-2):

demonstrations of system transients and electromagnetic interference (EMI) during normal operations.

(6) Section 25.1351(b)(5) - Power Source Disconnection.

(i) Verify that there are means accessible in flight to the appropriate crewmembers, for the individual and collective disconnection of the electrical power sources from the system.

(ii) Demonstrate that the airplane can be flown with one less generator than allowed by the Master Minimum Equipment List (MMEL). Also verify that prior to switching off the non-essential electrical loads specified in the AFM, the remaining generators' short term (up to 5 minutes) capacity is not exceeded.

(7) Section 25.1351(b)(6) - Power Source Indicators.

(i) Verify that there are means to indicate, to the appropriate crewmembers, the generating system quantities essential for the safe operation of the system, such as the voltage and current supplied by each power source, if appropriate to type of aircraft, i.e., glass cockpit design may provide information on MFD (ECAM, EICAS, etc.)

(ii) Verify proper operation of electrical power system warning, caution, and advisory indications, if any, and that these indications comply with §§ 25.1309(c) and 25.1322.

(8) Section 25.1351(c) - External Power. If provisions are made for connecting external power to the airplane, and that external power can be electrically connected to equipment other than that used for engine starting, verify that a means is provided to ensure that no external power supply having a reverse polarity, a reverse phase sequence, overvoltage, or reverse phase/neutral can supply power to the airplane's electrical system. This demonstration may be accomplished in a laboratory environment.

(9) Section 25.1351(d) - Operation Without Normal Electrical Power. It must be demonstrated that the airplane can be operated safely in Visual Flight Rule (VFR) conditions, for a period of not less than five minutes, with the normal electrical power (electrical power sources excluding the battery) inoperative, with critical type fuel (from the standpoint of flameout and restart capability), and with the airplane initially at the maximum certificated altitude.

(10) Emergency Electrical Power System.

(i) For airplanes with a type certification basis that includes Amendment 25-23, the FAA has applied a general requirement that following total failure of the electrical power system, if not shown to be extremely improbable, emergency electrical power must be available to power instrument displays, systems, equipment, or parts of the airplane essential for safety of flight during Instrument Meteorological Condition (IMC) operations for at least 30 minutes. It may also be advisable to check that in the event when normal operation is reestablished following the use of emergency power devices, such devices can withstand, or at least do not adversely affect, the subsequent reversion to "normal" operation.

Section 3. ELECTRICAL SYSTEMS AND EQUIPMENT

186. GENERAL - § 25.1351.

- a. Explanation Section 25.1351(a) requires that the electrical generating capacity, and number and kinds of power sources, be determined by an electrical load analysis, and meet the requirements of § 25.1309.
- b. Procedures.
 - (1) Section 25.1351(a) - Electrical System Capacity. Section 25.1351(a) requires the generating capacity, and number and kinds of power sources, to be determined by an electrical loads analysis and meet the requirements of § 25.1309. Additionally, verify by flight test that cooling is satisfactory to maintain component temperatures within the manufacturer's limits, both on the ground and in flight, with the electrical system operating at maximum limit load.
 - (2) Section 25.1351(b)(1) - Electrical Power Configuration

- (i) Verify that electrical power sources function properly when independent and when connected in combination.
- (ii) For airplanes with autoland capability, verify proper electrical power reconfiguration for each available autoland mode.
- (iii) Verify that no hazardous airplane systems reaction occurs, to a partial loss of the electrical distribution system by simulating loss of individual busses. Simulate loss of individual busses by opening circuit breakers/relays.
- (iv) Verify proper transfer of electrical power between the different power sources (i.e., external power, APU, engines).
- (3) Section 25.1351(b)(2) - Failure of Power Source. Verify proper operation of system during simulated power failures by flight test functional demonstrations. It must be shown by design analysis or laboratory demonstration, that no failure or malfunction of any power source, including the battery can create a hazard or impair the ability of remaining sources to supply essential loads.
- (4) Section 25.1351(b)(3) - System Voltage and Frequency. For probable operating conditions, verify that system voltage and frequency, as applicable, at the terminals of all essential load equipment can be maintained within the limits for which the equipment is designed. This may be accomplished in a laboratory environment.
- (5) Section 25.1351(b)(4) - System Transients. It must be shown by design analysis, laboratory demonstration, and/or flight demonstration that system transients due to switching, fault clearing, or other causes during normal operations do not make essential loads inoperative, and do not cause a smoke or fire hazard. Flight test recordings may be useful to verify laboratory

(i) The evaluation should proceed to a g level that will allow recovery to be accomplished near +2.5g, unless sufficient buffet or other phenomena (natural, artificial, or a combination) of such intensity exists that is a strong and effective deterrent to further pilot application of nose-up longitudinal control force (as in § 25.201(d)(2)) so that there is no danger of exceeding the airplane limit load factor (Ref. § 25.143(b)).

NOTE: A strong and effective deterrent is analogous to that required for stall identification; stick shaker or stall warning buffet are not considered to be an adequate end point for these tests.

- (ii) Any pitching tendency (uncommanded changes in load factor) shall be mild and readily controllable.
- (iii) Sufficient control shall be available to the pilot, through unreversed use of only the primary longitudinal control, to effect a prompt recovery to +1g flight from the load factors described herein.
- (iv) The airplane's pitch response to primary longitudinal control shall be predictable to the pilot.

(B) Experience has shown that maneuvering evaluations conducted at the highest Mach and the highest weight and altitude (W/delta) combination may not necessarily produce the most critical results. Equally important is the character of the buffet buildup (e.g., slowly increasing or rapid rise, and the g at which it starts). Conditions associated with buffet onset near 2g at Mach numbers below M_{MO} have sometimes yielded the most critical characteristics. Therefore, a sufficient spread of conditions should be evaluated.

FIGURE 31-1. MANEUVERING CHARACTERISTICS
Speeds Up to the Lesser of V_{FC} or M_{FC} or

Buffet Onset at 1G

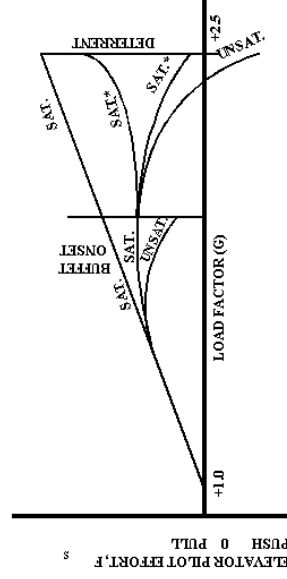

* These characteristics are satisfactory only in accordance with paragraphs b(5)(i)(A)(i) and (2).

FIGURE 31-2. MANEUVERING CHARACTERISTICS
Speeds Between Figure 31-1 and V_{PF} or M_{PF}

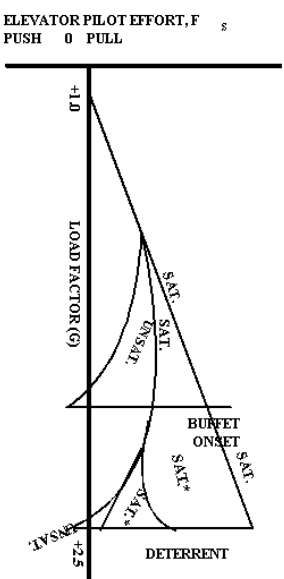

* These characteristics are satisfactory only in accordance with paragraphs b(5)(D)(A)(J) and (2).

32. HIGH SPEED CHARACTERISTICS - § 25.253;

a. Explanation.

(1) The maximum flight demonstrated dive speed, V_{FD}/M_{FD} , is used when establishing V_{MO}/M_{MO} and the associated speed margins under the provisions of § 25.1505. Both V_{MO} and M_{MO} are then evaluated during flight tests for showing compliance with § 25.253.

(2) The pitch upset described in § 25.335(b), as amended by Amendment 25-23, or § 25.1505, prior to Amendment 25-23, is for design criteria only. The operational upsets expected to occur in service for pitch, roll, yaw, and combined axis upsets are covered under § 25.253.

(3) In general, the same maneuvers should be accomplished in both the dynamic pressure and Mach critical ranges. All maneuvers in either range should be accomplished at thrust and trim points appropriate for the specific range. It must be realized that some maneuvers in the Mach range may be more critical for some airplanes due to drag rise characteristics, and that at high altitudes a lower gross weight may be required to achieve the maximum approved operating altitude and Mach/airspeed conditions.

(4) The airplane's handling characteristics in the high speed range should be investigated in terms of anticipated action on the part of the flightcrew during normal and emergency conditions.

(5) At least the following factors should be considered in determining the necessary flight tests:

- (i) Effectiveness of longitudinal control at V_{MO}/M_{MO} and up to V_{FD}/M_{FD} ;
- (ii) Effect of any reasonably probable mistrim on upset and recovery;
- (iii) Dynamic and static stability.

(H) The method used to measure altitude loss during (ILS) approach should be shown to be accurate to within ± 5 ft. for both coupled and uncoupled approaches, except that for uncoupled approaches where an applicant demonstrates autopilot malfunctions at Category I minimums, and elects to accept a restriction against the use of the autopilot below those minimums, he need not show that the method of measuring altitude loss meets the ± 5 ft. accuracy requirement.

(I) A malfunction of the autopilot during a coupled ILS approach should not place the airplane in an attitude that would preclude conducting a satisfactory go-around or landing.

(J) The flight path and altitude loss data, determined in accordance with the procedures described in this section, should be used to substantiate that if a hardover were to occur at 80 percent of the minimum decision height, the lowest part of the airplane will not penetrate the 29:1 minimum operational tolerance line that extends upward from a point 15 ft. above the runway threshold. It would, however, be permissible for the wheels to make contact with the runway in either a landing or go-around recovery maneuver.

(8) Airplane Flight Manual Information. The following information should be placed in the AFM:

(i) Operating Limitations Section: airspeed and other applicable operating limitations for use with the autopilot.

(ii) Operating Procedures Section: the normal operation information.

(iii) Emergency Operating Procedures Section: A statement of the maximum altitude loss experienced during malfunction tests in the cruise and maneuvering flight regimes. A statement of the altitude loss should be provided. Further, it should be stated that a 3-degree glideslope was used, and the altitude loss was measured from the glideslope path to a point where maximum vertical deviation from the glideslope exists.

[182 - 185] [RESERVED]

(B) A one second delay time following pilot recognition of the malfunction, through the behavior of the airplane or a reliable failure warning system, should be used for maneuvering flight malfunction testing.

(C) The altitude loss, for maneuvering flight testing, is the difference between the observed altitude at the time the malfunction is introduced, and the lowest altitude observed in the recovery maneuver.

(vi) Automatic Pilot Instrument Landing System (ILS) Approach

(A) All ILS approach malfunctions must be conducted on an ILS facility having a 3-degree glide path.

(B) Throughout an approach, no signal or combination of signals simulating the cumulative effect of any single failure or malfunction in the automatic pilot system, except vertical gyro mechanical failures, should provide hazardous deviations from the flight path or any degree of loss of control if corrective action is initiated one second after the pilot has become alerted to the malfunction.

(C) The airplane should be flown down the ILS in the configuration and at the approach speed specified by the applicant for approach. Simulated autopilot malfunctions should be induced at critical points along the ILS, taking into consideration all possible variations in autopilot sensitivity and authority. The malfunctions should be induced about each axis. A simulator may be adequate for this test.

(D) Automatic pilot system ILS approach malfunctions should be conducted at a safe altitude in "under-the-hood" simulated Instrument Meteorological Conditions (IMC).

(E) The automatic pilot system should be capable of continuing the approach without retrimming the airplane after failure of the critical engine; however, a change in heading at a rate not greater than 3 degrees per second (averaged over a five-second period) would be acceptable. The rate of heading change encountered should be described in the normal or abnormal procedures section of the AFM, whichever is appropriate. The engine failure should not produce hazardous attitudes.

(F) If approval is sought for ILS approaches initiated with one engine inoperative and the airplane trimmed at glideslope intercept, the automatic pilot should be capable of conducting the approach without further trimming. For airplanes with three or more engines, the loss of a second critical engine should not cause a rate of lateral deviation from the ILS course greater than 3 degrees per second, or produce hazardous attitudes.

(G) For coupled and uncoupled approaches, recoveries should be initiated one second after the pilot recognizes the autopilot failure under simulated IFR conditions. The airplane should be on glideslope center when malfunctions are introduced. The altitude loss, measured from the glideslope path to a point where maximum vertical deviation from glideslope exists, should be recorded and presented in the AFM. This is the critical altitude loss from the standpoint of obstacle and ground clearance.

(iv) The speed increase that results from likely passenger movement when trimmed at any cruise speed to V_{MO}/M_{YO} .

(v) Trim changes resulting from compressibility effects.

(vi) Characteristics exhibited during recovery from inadvertent speed increase.

(vii) Upsets due to vertical and horizontal gusts (turbulence).

(viii) Speed increases due to horizontal gusts and temperature inversions.

(ix) Effective and unmistakable aural speed warning at V_{MO} plus 6 knots, or M_{YO} plus 0.01M.

(x) Speed and flightpath control during application of deceleration devices.

(xi) The manageability of control forces resulting from the application of deceleration devices.

(6) Section 25.1505 states that the speed margin between V_{MO}/M_{YO} and V_{DP}/M_{DP} or V_{DP}/M_{DP} , as applicable, "may not be less than that determined under § 25.335(b) or found necessary during the flight tests conducted under § 25.253." Historically, this speed margin allowance for atmospheric variations (e.g., horizontal gusts, penetration of jet streams and cold fronts), instrument errors, and airframe production tolerances has been interpreted as .05M in the Mach limited portion of the flight envelope. However, studies conducted by industry during the 1980s have shown that for a conventional aircraft, atmospheric disturbances resulted in larger airspeed variations than accounted for by the .05M minimum margin. Consequently, this speed margin was increased to .07 Mach by Amendment 25-91, with an allowance for reducing the margin to the old value of .05M if justified by a rational analysis. In establishing the minimum speed margins during type certification programs, the factors outlined in paragraph (5), above, should also be considered in addition to the items listed below:

(i) Increment allowance for production tolerances in airspeed systems (0.005M), unless larger differences are found to exist.

(ii) Increment allowance for production tolerances of overspeed warning error (0.01M), unless larger tolerances or errors are found to exist.

(iii) Increment allowance ΔM due to speed overshoot from M_{YO} established by upset during flight tests in accordance with § 25.253, should be added to the values for production differences and equipment tolerances, and the minimum acceptable combined value should not be less than .07M between M_{YO} and M_{DP}/M_{DP} . The value of M_{YO} then should not be greater than the lowest value obtained from each of the following equations and from § 25.1505:

$$M_{MO} \leq M_{DP}/M_{DP} - \Delta M - .005M - .01M$$

or

$$M_{MO} \leq M_{DP}/M_{DP} - .07M$$

NOTE: The combined minimum increment may be reduced from .07M to as small as .05M if justified by the rational analysis used to show compliance with § 25.335(b)(2).

(iv) At altitudes where V_{MO} is limiting, the increment allowance for production differences of airspeed systems and production tolerances of overspeed warning errors are 3 and 6 knots, respectively, unless larger differences or errors are found to exist.

(v) Increment allowance ΔV due to speed overshoot from V_{MO} , established by upset during flight tests in accordance with § 25.253, should be added to the values for production differences and equipment

tolerances. The value of V_{MO} should not be greater than the lowest obtained from the following equation, and from § 25.1505:

$$V_{MO} \leq V_{IV}/V_{DF} - \Delta V \quad - \quad 3 \text{ knots} \quad - \quad 6 \text{ knots} \quad - \quad \text{(production differences)} \quad - \quad \text{(equipment tolerances)}$$

(vi) For an airplane with digital interface between the airspeed system and the overspeed warning system, the production tolerance for the warning system may be deleted when adequately substantiated.

b. Regulations Affected. These criteria refer to certain provisions of Part 25 of the Federal Aviation Regulations (FAR). They may also be used in showing compliance with the corresponding provisions of the former Civil Air Regulations (CAR) in the case of airplanes to which those regulations are applicable. Other affected FAR are as follows:

Section 25.175(b) Demonstration of static longitudinal stability.

Section 25.251 Vibration and buffeting.

Section 25.253 High-speed characteristics.

Section 25.335(b) Design dive speed, V_D .

Sections 25.1303(b)(1) and (c) Flight and navigation instruments.

Section 25.1505 Maximum operating limit speed.

c. Procedures. Using the speeds V_{MO}/M_{MO} and V_{DF}/M_{DF} determined in accordance with §§ 25.1505 and 25.251, respectively, and the associated speed margins, the airplane should be shown to comply with the high-speed characteristics of § 25.253. Unless otherwise stated, the airplane characteristics should be investigated at the most critical speed up to and including V_{MO}/M_{MO} and the recovery procedures used should be those selected by the applicant, except that the normal acceleration during recovery should be no more than 1.5g (total). Testing should be conducted with the c.g. at the critical position and generally perpendicular to local wind aloft.

(1) Center of Gravity Shift. The airplane should be upset by the center of gravity shift corresponding to the forward movement of a representative number of passengers (and/or serving carts) depending upon the airplane interior configuration. The airplane should be permitted to accelerate until 3 seconds after effective overspeed warning.

(2) Inadvertent Speed Increase. Simulate an evasive control application when trimmed at V_{MO}/M_{MO} , by applying sufficient forward force to the pitch control to produce 0.5g (total) for a period of 5 seconds, after which recovery should be effected at not more than 1.5g (total).

(3) Gust Limit. In the following three upset tests, the values of displacement should be appropriate to the airplane type and should depend upon airplane stability and inertia characteristics. The lower and upper limits should be used for airplanes with low and high maneuverability, respectively.

(i) With the airplane trimmed in wings-level flight, simulate a transient gust by rapidly rolling to the maximum bank angle appropriate for the airplane, but not less than 45 degrees nor more than 60 degrees. The rudder and longitudinal control should be held fixed during the time that the required bank is being attained. The rolling velocity should be arrested at this bank angle. Following this, the controls should be abandoned for a minimum of 3 seconds after overspeed warning or 10 seconds, whichever occurs first.

(ii) Perform a longitudinal upset from normal cruise. Airplane trim is determined at V_{MO}/M_{MO} using power/thrust required for level flight but with not more than maximum continuous power/thrust. This is followed by a decrease in speed after which an attitude of 6-12 degrees nose down, as appropriate for the airplane type, is attained with the power/thrust and trim initially required for V_{MO}/M_{MO} in level flight. The airplane is

(A) The more critical of the following should be induced into the automatic pilot system. If autothrottles are installed, they should be operating, and vertical gyro mechanical failures should not be considered:

(1) A signal about any axis equivalent to the cumulative effect of any single failure, including autotrim, if installed.

(2) The combined signals about all affected axes, if multiple axis failures can result from the malfunction of any single component.

(B) Corrective action should not be initiated until three-seconds after the pilot has become aware, either through the behavior of the airplane or a reliable failure warning system, that a malfunction has occurred.

(C) The simulated failure and the subsequent corrective action should not result in normal accelerations below zero g or above 2 g's, speeds beyond V_{FC}/M_{FC} or result in dangerous dynamic conditions or deviations from the flight path. The positive "g" limitation may be increased up to the positive design limit maneuvering load factor, provided adequate analysis and flight test measurements are conducted to establish that no resultant airplane load is beyond limit loads for the structure, including a critical assessment and consideration of the effects of structural loading parameter variations, (i.e., center of gravity, load distribution, control system variations, etc.). Analysis alone may be used to establish that limit loads are not exceeded where the airplane loads are in the linear range of loading, (i.e., aerodynamic coefficients for the flight condition are adequately established and no significant nonlinear air loading exists). If significant nonlinear effects could exist (e.g., buffet loads), flight loads survey measurements may be necessary to substantiate that the limit loads are not exceeded.

(D) The power or thrust for climb should be the most critical of that used:

(1) In the performance climb demonstrations;

(2) In the longitudinal stability tests; or

(3) For normal operational speeds.

(E) The altitude loss for the cruise condition is the difference between the observed altitude at the time the malfunction is introduced, and the lowest altitude observed in the recovery maneuver.

(V) Maneuvering Flight.

(A) Maneuvering flight tests should include turns with the malfunctions introduced when maximum bank angles for normal operation of the system have been established, and in the critical airplane configuration and/or stages of flight likely to be encountered when using the automatic pilot.

permitted to accelerate until 3 seconds after overspeed warning. The force limits of § 25.143(c) for short term application apply.

(iii) Perform a two-axis upset, consisting of combined longitudinal and lateral upsets. Perform the longitudinal upset, as in paragraph (ii) above, and when the pitch attitude is set, but before reaching V_{MO}/M_{MO} , roll the airplane 15-25 degrees. The established attitude should be maintained until 3 seconds after overspeed warning.

(4) Leveling Off from Climb. Perform transition from climb to level flight without reducing power below the maximum value permitted for climb until 3 seconds after overspeed warning. Recovery should be accomplished by applying not more than 1.5g (total).

(5) Descent from Mach Airspeed Limit Altitude. A descent should be performed at the airspeed schedule defined by M_{MO} and continued until 3 seconds after overspeed warning occurs, at which time recovery should be accomplished without exceeding 1.5g (total).

(6) Application of Deceleration Devices. It should be demonstrated that extension of the airbrakes at high speeds will not result in excessive flight path deviation. With the airplane trimmed for level flight at V_{MO}/M_{MO} , extension of the airbrakes to any position that may be selected by the pilot's control, at speeds above V_{MO}/M_{MO} but not so high that V_{DF}/M_{DF} would be exceeded during the maneuver, should not result in:

- (i) A positive normal load factor greater than 2.0 with the stick free; or
- (ii) A nose down pitching moment that requires more than a 20 pound longitudinal control force to maintain 1g flight.

33. OUT-OF-TRIM CHARACTERISTICS - § 25.255.

a. Explanation. Certain early, trimmable stabilizer equipped jet transports experienced "jet upsets" that resulted in high speed dives. When the airplane was mistrimmed in the nose-down direction and allowed to accelerate to a high airspeed, it was found that there was insufficient elevator power to recover. Also, the stabilizer could not be trimmed in the nose-up direction, because the stabilizer motor stalled due to excessive airloads imposed on the horizontal stabilizer. As a result, a special condition was developed and applied to most Part 25 airplanes with trimmable stabilizers. With certain substantive changes, it was adopted as § 25.255, effective with Amendment 25-2. While these earlier problems seem to be generally associated with airplanes having trimmable stabilizers, it is clear from the preamble discussions to Amendment 25-42 that § 25.255 applies "regardless of the type of trim system used in the airplane." Section 25.255 is structured to give protection against the following unsatisfactory characteristics during mistrimmed flight in the higher speed regimes:

- (1) Changes in maneuvering stability leading to overcontrolling in pitch.
 - (2) Inability to achieve at least 1.5g for recovery from upset due to excessive control forces.
 - (3) Inability of the flightcrew to apply the control forces necessary to achieve recovery.
 - (4) Inability of the pitch trim system to provide necessary control force relief when high control force inputs are present.
- b. Reference Regulation. Section 25.255
 - c. Discussion of The Regulation.

(1) Section 25.255(a) is the general statement of purpose. Maneuvering stability may be shown by a plot of applied control force versus normal acceleration at the airplane center of gravity. Mistrim must be set to the greater of the following:

(i) Section 25.255(a)(1). A 3-second movement of the longitudinal trim system at its normal rate for the particular flight condition with no aerodynamic load. Since many modern trim systems are variable rate

(L) The airplane should be instrumented such that parameters appropriate to the tests are recorded (e.g., normal acceleration, airspeed, altitude, pitch and roll attitude, automatic pilot engagement discrete).

(ii) Monitored/Voted Automatic Systems.

(A) Earlier autopilot certifications dealt with systems using torque-limited servos as a means of compliance. Modern systems use such techniques as electronic limiters, g-limiters, rate limiters, etc.; force voting, rate voting, etc.; monitors that disengage the system, and monitors that revert to operating channels, etc.; in order to increase the system capability and meet the malfunction requirements. These systems should be expected to exhibit malfunction characteristics equal to, or better than, the torque-limited servo systems.

(B) The applicant's analysis and iron bird testing of monitored and/or voted systems should tend to reduce flight evaluation. Evaluation at selected flight conditions should be performed to substantiate proper system operation and correlation of analysis.

(iii) Oscillatory Tests.

(A) An investigation should be made to determine the effects of an oscillatory signal of sufficient amplitude to saturate the servo amplifier of each device that can move a control surface. The investigation should cover the range of frequencies that can be induced by a malfunction of the automatic pilot system and systems functionally connected to it, including an open circuit in a feedback loop. The investigated frequency range should include the highest frequency that results in apparent movement of the system driving the control surface to the lowest elastic or rigid body response frequency of the airplane. Frequencies less than 0.2 Hz may, however, be excluded from consideration. The investigation should also cover the normal speed and configuration ranges of the airplane. The results of this investigation should show that the peak loads imposed on the parts of the airplane by the application of the oscillatory signal are within the limit loads for these parts. Autopilot systems that contain integral performance envelope limiting cut-out functions may be exempt from this requirement, provided the integrity of the monitor is demonstrated in the normal way.

(B) The investigation may be accomplished largely through analysis with sufficient flight data to verify the analytical studies, or largely through flight tests with analytical studies extending the flight data to the conditions that impose the highest percentage of limit load to the parts.

(C) When flight tests are conducted in which the signal frequency is continuously swept through a range, the rate of frequency change should be slow enough to permit determination of the amplitude of response of any part under steady frequency oscillation at any critical frequency within the test range.

(iv) Climb, Cruise and Descent Flight Regimes.

systems, this subsection requires that the maneuver condition be defined and that the no-load trim rate for that condition be used to set the degree of mistrim required. For airplanes that do not have power-operated trim systems, experience has shown a suitable amount of longitudinal mistrim to be applied is that necessary to produce a 30 pound control force, or reach the trim limit, whichever occurs first.

(ii) Section 25.255(a)(2). The maximum mistrim that can be sustained by the autopilot while maintaining level flight in the high speed cruising condition. The high speed cruising condition corresponds to the speed resulting from maximum continuous power or thrust, or V_{MO}/M_{MO} , whichever occurs first. Maximum autopilot mistrim may be a function of several variables, and the degree of mistrim should therefore correspond to the conditions of test.

(2) Section 25.255(D) establishes the basic requirement to show positive maneuvering stability throughout a specified acceleration envelope at all speeds to V_{FC}/M_{FC} and the absence of longitudinal control force reversals throughout that acceleration envelope at speeds between V_{FC}/M_{FC} and V_{YF}/M_{DF} . (Later subsections (d) and (e) recognize that buffet boundary and control force limits will limit the acceleration actually reached; this does not account for Mach trim gain, etc.)

(i) Section 25.255(b)(2), taken at face value, indicates that unstable airplane characteristics would be satisfactory, regardless of the character of the primary longitudinal control force as load factor is increased, as long as the force did not reverse (e.g., from a pull to a push). While such criteria may have merit for evaluating airplanes when starting the maneuver from a trimmed condition, it can be shown that this provides an anomalous specification for evaluation of an airplane's maneuvering characteristics when starting the test from the specified mistrimmed condition. For example, an airplane would have unacceptable characteristics with a nose-up mistrim, if while relaxing the large initial elevator push force to increase the load factor to the specified value, the elevator force just happened to cross through zero to a slight pull force at one load factor, and then back through zero to a push force at a higher load factor. Such an airplane's characteristics are clearly superior to one that has a severe elevator force slope reversal, during the same maneuver, but never reaches a zero elevator force condition as the load factor is increased: a literal interpretation of § 25.255(b)(2) would pass this airplane while failing the preceding airplane because it had a slight reversal of the primary longitudinal control force.

(ii) Section 25.255(b)(2) should be interpreted to mean that the primary longitudinal control force, for load factors greater than 1.0, may not be less than that used to obtain the initial 1g flight condition. This is illustrated in Figure 33-1 and is consistent with the criteria depicted in Figure 31-2 for in-trim maneuver stability. Slight control force reversals, as discussed in paragraph (i), above, will be permitted for speeds between V_{FC}/M_{FC} and V_{YF}/M_{DF} only if:

- (A) No severe longitudinal control force slope reversals exist;
- (B) Any pitching tendency (uncommanded changes in load factor) shall be mild and readily controllable; and
- (C) The airplane's pitch response to primary longitudinal control shall be predictable to the pilot.

FIGURE 33-1. MISTRIMMED MANEUVERING CHARACTERISTICS
Speeds Between V_{FC}/M_{FC} and V_{YF}/M_{DF}

(D) A three-second delay added to the measured time increment between pilot recognition of an automatic pilot malfunction and pilot corrective action has been considered acceptable for climb, cruise, and descent phases of flight. Similarly, a one-second delay has been applied during Instrument Landing System (ILS) low approach autopilot malfunction testing. For control wheel steering (CWS) mode of operation during takeoff, go-around, and landing, no delay time need be applied. Since present operating procedures require that at least one pilot monitor the behavior of the airplane and associated autopilot performance at all times, these delay times are considered reasonable. Finally, auto/land and go-around mode hardovers (below Category II minimums) should be "no-delay" events.

(E) The area of normal maneuvering flight (turning flight) has not been specified for evaluation of the effects of autopilot malfunctions, although autopilots are commonly used in turning flight. A one-second delay is considered reasonable, following pilot recognition of a malfunction, prior to undertaking corrective action.

(F) It is necessary to establish satisfactory airplane response to autopilot hardovers throughout the entire certificated airspeed/altitude flight envelope. Since loading limitations of the test airplane preclude investigation of the entire flight envelope for which certification is requested, simulation results may be used to validate response in the unreachable center of gravity vs. weight combinations.

(G) The nominal worst-case weight/c-g combinations achievable by the test airplane, as predicted by simulation results, must be flight tested. The justification for selection of the weight/c-g combinations proposed for testing must be submitted for FAA review prior to type inspection authorization (TIA) issuance.

(H) The analysis must also present a comprehensive exploration of airplane "g" responses throughout the weight/c-g-airspeed-altitude flight envelope, including worst case and envelope boundary conditions. The analysis should include flight test and simulator responses adjusted for the presence of worst-case system tolerance effects.

(I) During recovery from an automatic pilot system malfunction, the pilot may overpower the autopilot or disengage it. The pilot should be able to return the airplane to its normal flight attitude under full manual control, without exceeding the loads or speed limits appropriate to the flight condition, without engaging in any dangerous maneuver during recovery, and without control forces exceeding the values given in § 25.143(c).

(J) In general, malfunction demonstrations may be restricted to hardovers (and, possibly, automatic trim failures), unless the autopilot is intended to be engaged in the takeoff and go-around modes at altitudes below 1,000 ft. AGL (if applicable), or if the automatic ILS approach mode of operation is intended to be extended below 100 ft. radio altitude in a non-fail passive configuration. In these cases, malfunction at runway rates lower than a hardover (i.e., slowovers) should also be investigated. Verification of failure effects may be permissible in the simulator environment.

(K) If an automatic throttle system (ATS) is installed, the malfunctions should be examined with and without the ATS operating.

(i) It should be possible for the pilot to overpower the automatic pilot system, and achieve the maximum available control surface deflection, without using forces that exceed the pilot control force limits specified in § 25.143(c).

(ii) The maximum bank and pitch attitudes that could be achieved without overpowering the automatic pilot system should be limited to those necessary for the normal operation of the airplane. Typically $\pm 55^\circ$ in roll and $+20^\circ$ to -10° in pitch.

(iii) It should be possible to carry out all normal maneuvers and to counter normal changes of trim due to change of configuration etc., within the range of flight conditions in which control wheel steering may be used, without encountering excessive discontinuities in control force that might adversely affect the flight path.

(iv) The stall and stall recovery characteristics of the airplane should remain acceptable with control wheel steering in use.

(v) In showing compliance with § 25.143(e), account should be taken of such adjustment to trim as may be carried out by the automatic pilot system in the course of maneuvers that can reasonably be expected. Some alleviation may be acceptable in the case of unusually prolonged maneuvers, provided the reduced control forces would not be hazardous.

(vi) If the use of this mode for takeoff and landing is to be permitted, it should be shown that:

(A) Sufficient control, both in amplitude and rate, is available without encountering force discontinuities;

(B) Reasonable mishandling is not hazardous (e.g. engaging the autopilot while the elevators or ailerons are held in an out-of-trim position); and

(C) Runaway rates and control forces are such that the pilot can readily overpower the automatic pilot with no significant error in flight path.

(7) Failure Modes/Malfunction Tests.

(i) General.

(A) Failure conditions of the system should be simulated in such a manner as to represent the overall effect, and worse case effect, of each failure condition about all axes.

(B) Investigations should include the effects of any failure, and any combination of failures, not shown to be extremely improbable.

(C) During malfunction testing, the recognition point should be that at which a line pilot in non-visual conditions may be expected to recognize the need to take action, and not that at which the test pilot does so. Recognition of the malfunction may be through the behavior of the airplane or a reliable failure warning system, and the recognition point should be identified. Control column or wheel movements alone should not be used for recognition.

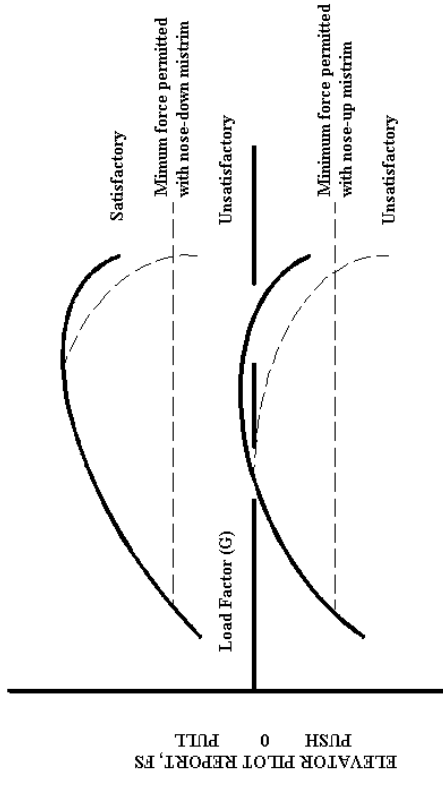

(3) Section 25.255(c) requires that the investigation of maneuvering stability (§ 25.255(b)) include all attainable acceleration values between $-1g$ and $+2.5g$. Sections 25.333(b) and 25.337, to which it refers, limit the negative g maximum to $0g$ at V_D . Section 25.251 further limits the g to that occurring in probable inadvertent excursions beyond the buffet onset boundary at those altitudes where buffet is a factor.

(4) Section 25.255(c)(2) allows for extrapolation of flight test data by an acceptable method. For example, if the stick force gradient between 0 and $+2g$ agrees with predicted data, extrapolation to $-1g$ and $2.5g$ should be allowed.

(5) Section 25.255(d) requires flight tests to be accomplished from the normal acceleration at which any marginal stick force reversal conditions are found to exist to the applicable limits of § 25.255(b)(1). This requirement takes precedence over the extrapolation allowance described in paragraph (4), above.

(6) Section 25.255(e) limits the investigation to the required structural strength limits of the airplane and maneuvering load factors associated with probable inadvertent excursions beyond the boundary of the buffet onset envelope. It also accounts for the fact that speed may increase substantially during test conditions in the $-1g$ to $+1g$ range. It limits the entry speed to avoid exceeding V_{YF}/M_{YF} .

(7) Section 25.255(f) requires that in the out-of-trim condition of paragraph (a) it must be possible to produce at least $1.5g$ during recovery from the overspeed condition of V_{YF}/M_{YF} . If adverse flight characteristics preclude the attainment of this load factor at the highest altitude reasonably expected for recovery to be initiated at V_{YF}/M_{YF} following an upset at high altitude, the flight envelope (e.g., V_{YF}/M_{YF} , altitude, etc.) of the airplane should be restricted to a value where $1.5g$ is attainable. If trim must be used for the purpose of obtaining $1.5g$, it must be shown to operate with the primary control surface loaded to the least of three specified values.

(i) The force resulting from application of the pilot limit loads of § 25.397 (300 lbs.).

(ii) The control force required to produce $1.5g$ (between 125 and 300 lbs.).

(iii) The control force corresponding to buffeting or other phenomena of such intensity that it is a strong deterrent to further application of primary longitudinal control force.

d. Procedures.

- (1) Basic compliance is determined by the characteristics of Fsg (normally a plot). Any standard flight test procedure that yields an accurate evaluation of Fsg data in the specified range of speeds and acceleration should be considered for acceptance. Bounds of investigation and acceptability are set forth in the rule and in discussion material above, and broad pilot discretion is allowed in the selection of maneuvers.
- (2) Investigation Range. Out-of-trim testing should be done at the most adverse loading for both high and low control forces. Testing should be accomplished both at the "Q" and Mach limits.
- (3) The ability to actuate the primary controls (including trim), when loaded, should be considered prior to the tests.

(D) Failure modes/conditions described in paragraph 181b(7)(vi) of this AC, appropriate to ILS approach modes, should be conducted.

(E) The definition of a successful approach is one that positions the airplane at the decision height (DH), such that the airplane can be safely landed.

(iii) For airworthiness approval to Category II (CAT II) minimums for each candidate system (autonomous pilot, flight director and HUD):

(A) Conduct a series of approaches on CAT II rated ILS beams to a radio altitude of 100 feet.

(B) For initial system approval, approximately 20 approaches (total for each affected system) are required to examine each configuration/combinations of equipment for which the applicant seeks credit.

(C) At least three Cat II beams should be included in the evaluation.

(D) When relatively minor changes are made to the approach control laws or when a different display (i.e., flight director instrument) is incorporated with the system, approximately 9 approaches (total for each affected system) have been found to be sufficient (i.e., 3 each on 3 different ILS beams).

(E) The approaches should be made in conditions chosen to show that the performance is satisfactory within the permitted extremes of weight, center of gravity, wind speed, localizer capture angles, glide slope captures from below and above (if appropriate) the beam, captures at various ranges from runway threshold, etc.

(iv) If approval is sought for ILS approaches initiated with one engine inoperative, and with the airplane trimmed at the point of glide path intercept, the automatic flight control system should be capable of conducting the approach without further manual trimming. For airplanes with three or more engines, the loss of a second critical engine should not cause a rate of lateral deviation from the ILS course greater than 3° per second (averaged over a 5-second period), or produce hazardous attitudes.

(v) Unless it is shown that failure of the automatic pilot system to disengage during the approach, when the pilot operates the quick release control on the control wheel, is improbable, then it should be demonstrated that the pilot can control the airplane manually without operating any of the other disengagement controls.

(vi) It is possible that many of the above tests can be performed in a simulator environment.

(6) Control Wheel Steering (CWS).

Hold or Vertical Speed or Altitude Hold or VNAV; from roll axis go-around mode to Heading Select or VOR or LNAV; etc.).

CHAPTER 3 - STRUCTURE

[RESERVED]

(xxii) Evaluate all reversion modes appropriate to the design. Most speed command go-around modes will be fail-passive (or "fail-soft") and will probably contain reversion modes. Consult the system description, the FMEA, and the responsible system engineer for definition of the appropriate evaluation. It may be possible to perform this testing in a simulator.

(xxiii) Evaluate adequacy of mode annunciations and controls and displays associated with the go-around maneuver.

(xxiv) Evaluate the go-around pitch attitude limit (if applicable) for compatibility and command harmony.

(xxv) "Fixed Pitch Go-Around." Missed approaches using the calibrated attitude markings on the Attitude Director Indicator (ADI) should be demonstrated to be an acceptable alternative technique for low visibility operations (CAT II & CAT III), in the event that automatic or flight director go-around modes are not available. A sufficient sample size should be collected to establish the transitional altitude loss. The target attitude for go-around (13 to 17 degrees is usually the target) should be established by the applicant. Use normal cleanup procedures. Simulate various failure conditions that would force the pilot to revert to this configuration. (e.g., simultaneous loss of autoland and go-around computation).

(xxvi) Quantitative time-history data should be derived with an on-board data system to facilitate post-flight evaluation of performance and to provide TIR records.

(5) Instrument Landing System (ILS) Approach Mode.

(i) A complete and comprehensive description of flight test evaluation for automatic pilot and flight director system ILS approach mode approval, including head-up displays (HUD), is contained in Advisory Circular 120-29, "Criteria for Approval Category I and Category II Landing Minima for FAR 121 Operators," and in Advisory Circular 91-16, "Category II Operations -General Aviation Airplanes." Further guidance is provided herein.

(ii) For airworthiness approval to Category I (CAT I) minimums:

(A) Conduct a series of approaches (usually 4 or more) on CAT I rated ILS beams to a radio altitude of 160 ft. (20 percent below the CAT I decision height of 200 ft).

(B) Conduct the approaches with and without automatic throttles, with and without yaw damper; alternate flap setting and so forth, for all configurations and combinations of equipment for which the applicant seeks approval.

(C) At least three CAT I beams should be included in the evaluation, one of which should exhibit very noisy localizer and glideslope characteristics.

CHAPTER 4 - DESIGN AND CONSTRUCTION

Section 1. GENERAL [RESERVED]

Section 2. CONTROL SURFACES [RESERVED]

Section 3. CONTROL SYSTEMS

34. GENERAL - § 25.671.

a. Explanation. This material deals with the all-engines out case of § 25.671(d). The intent of this rule is to assure that in the event of failure of all engines, the airplane will be controllable and an approach and landing flare possible. This may be done by analysis where the method is considered reliable.

b. Procedures. The airplane should be evaluated to determine that:

(1) It is controllable following the failure of all engines in the climb, cruise, descent, approach, and holding configurations and can be flared to a landing attitude from a reasonable approach speed. The airplane must be controllable when all engines fail in each of the specified configurations and in any specific configuration that is to be selected and maintained following the failure of the engines in accordance with the AFM emergency operating procedures.

(2) The effectiveness of the emergency power to drive the airplane control system, whether generated from a windmilling engine or an auxiliary power supply, should be demonstrated in flight.

(3) For airplanes with fully powered or electronic-flight control systems, the emergency procedures section of the approved Airplane Flight Manual should contain the appropriate operating procedures and a statement similar to the following:

"The airplane has a fully powered (or electronic) control system that is dependent upon engine windmill RPM, or an auxiliary power supply, to provide the necessary source of control system power in the event all engines fail in flight. A minimum airspeed of ~~XXX~~ knots IAS will provide adequate hydraulic or electrical power for airplane controllability in this emergency condition."

35. - 45. [RESERVED]

46. FLAP AND SLAT INTERCONNECTIONS - § 25.701.

a. Explanation. In accordance with § 25.701(a), if the wing flaps are not mechanically interconnected, tests or analysis should be conducted to simulate appropriate flap malfunctioning during takeoffs, approaches, and landings to demonstrate that the airplane is safe under these conditions. This demonstration should not require exceptional pilot skills or strength.

b. Reference. See paragraph 20a(4) of this AC and Advisory Circular 25-14, "High Lift and Drag Devices," dated May 4, 1988, for additional guidance.

c. Procedures. As appropriate to the installation.

47. TAKEOFF WARNING SYSTEM - § 25.703. [RESERVED]

FIGURE 181-1

ALTITUDE LOSS VERSUS ALTITUDE GO-AROUND MODE

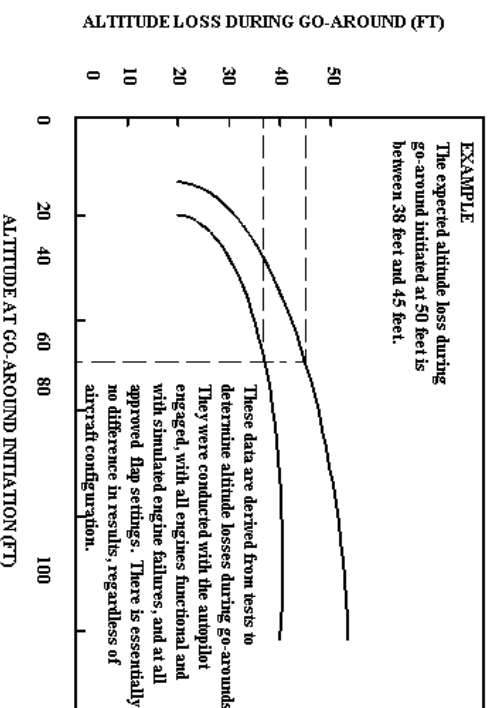

(xvii) Evaluate the go-around maneuver under conditions with automatic spoilers armed and go-around initiated at a low altitude, which results in wheel contact with the runway surface. Verify that momentary deployment of the ground spoilers under these conditions is acceptable.

(xviii) In addition to evaluation of speed performance to the criteria shown in Table 2 of Advisory Circular 25-15, "Approval of Flight Management Systems in Transport Category Airplanes," evaluate command bar lability, the dynamics of the airplane while following the commanded guidance, etc. The control action and flight path during the initial rotation should not be significantly different from those of a manually controlled go-around without command guidance.

(xix) The go-around from any point on the approach to touchdown should not require exceptional piloting skill, alertness, or strength, and must ensure that the airplane remains within the obstacle limitation surface specified in Advisory Circular 120-29, "Criteria for Approving Category I and Category II Landing Minima for FAR 121 Operators."

(xx) Evaluate pitch axis go-around mode behavior with simultaneous heading select turns during climb-out.

(xxi) Evaluate mode transitions from go-around to other approved modes using flight director, HUD, and automatic pilot guidance (i.e., from pitch axis go-around mode to IAS

Section 4. LANDING GEAR

(xvii) If the airplane is to be approved for Category III operations, the go-around altitude loss information must be included in the Airplane Flight Manual (see paragraph 7a of Advisory Circular 120-28C). The preferred format for presentation of this information in the AFM is as a cross-plot of altitude loss (ordinate of the crossplot) versus altitude of mode initiation (abscissa of the crossplot) as shown below.

48. - 51. [RESERVED]

52. RETRACTING MECHANISM - § 25.729.

a. Explanation. None.

b. Procedures.

(1) In accordance with the provisions of § 25.729, flight tests should be conducted to demonstrate the ability of the landing gear and associated components, in their heaviest configuration, to properly extend and retract at:

- (i) V_{LO} (the placard airspeed) in the cruise configuration at near 1g flight and normal yaw angles; and
- (ii) airspeeds and flap settings corresponding to typical landings. The landing gear operating placard airspeed, V_{LO} , established in accordance with § 25.11515(a), should not exceed the $1.6 V_{S1}$ design value of § 25.729(a)(1)(ii).

NOTE: "Normal" yaw angles are those associated with engine-out flight and counteracting crosswinds of up to 20 knots.

(2) The alternate extend system should be demonstrated at airspeeds up to V_{LO} at near 1g flight and normal yaw angles. An envelope of emergency extension capability should be established and presented in the emergency operating procedures section of the AFM. (Refer to NOTE paragraph above.)

(3) Operation test.- § 25.729(d).

(i) The engine-out gear retraction time should be determined from flight tests with one engine at idle power and the operating engine(s) adjusted to provide the lowest thrust-to-weight ratio to be certificated. The hydraulic system should be in the critical configuration corresponding to an actual engine failure condition. The airplane should be stabilized on a steady heading before gear retraction is initiated. The resulting gear retraction time will be used in developing AFM takeoff flight path performance information in accordance with § 25.111.

(ii) Gear retraction time is the time from landing gear lever movement to the "UP" position until the last landing gear, including doors, is in the retracted configuration. Allowance should be made for any delays associated with the landing gear indication system.

(4) Position indication and aural warning, § 25.729(e): It should be confirmed that the actual landing gear position agrees with the position indicated on the landing gear indicator. Landing gear aural warning should meet the intent of §§ 25.729(e)(2) through (e)(4). A combination of flight tests, ground tests, and analysis may be used to show compliance with these requirements.

53. WHEELS - § 25.731.

a. References.

(1) Technical Standard Order (TSO) C26c, "Airframe Wheels and Wheel-Brake Assemblies, with Addendum I," dated May 18, 1984, for additional guidance.

(2) Paragraph 55b(4)(vi) of this AC, Wheel Fuse Plugs.

(3) Paragraph 55c(7) of this AC, Wheel Fuse Plug Design.

1992.

(4) Advisory Circular 21-29A, " Detecting and Reporting Suspected Unapproved Parts, " dated July 16,

b. Explanation.

(1) Background.

(i) Original guidelines for wheels in § 4b.335 of the Civil Air Regulations (CAR) were superseded by TSO-C26 and subsequent revisions. Early versions of TSO-C26 referred to minimum standard requirements in versions of Society of Automotive Engineers (SAE) Aeronautical Standard (AS) 227. Minimum standards were subsequently specified in TSO-C26b and later revisions. For braked wheels, wheels and brakes must be approved as an assembly in recognition of design and safety interdependencies associated with thermal control, vibration control, structural stresses, etc. References (2) and 3) of paragraph a. above, provide insight into the criticality of proper fuse function to support airworthiness. As demands increased for longer life wheels and more robust designs, changes were introduced such as the addition of combined vertical and side loads for a portion of roll testing; an increase in roll miles at maximum static load from 1,000 to 2,000 miles; and addition of a roll-on-rim requirement to increase robustness in wheel flange areas.

(ii) In most cases, wheels are usually removed from service based upon condition. Typically, inspection frequency will increase as life on a particular wheel is accumulated in accordance with the wheel and brake suppliers Component Maintenance Manual (CMM). If wheel failures occur on the airplane, they typically occur when the airplane is on the ground with wheel and tire assembly loaded.

(iii) The trend in certain airplane manufacturer specifications is to place additional longevity and safety focused test requirements on wheel and brake suppliers. Added requirements, such as fail safe design verification(s), testing to failure of uncorroded and corroded wheels, and mandated use of overpressurization protection devices (in addition to fuses) have been incorporated. With the introduction of longer life tires, the demands on wheels and components, such as wheel bearings, have further intensified as landings between inspections at tire overhauls have increased. In addition, airplane manufacturers should be involved in wheel design, test, and manufacturer approvals to ensure that airplane specific needs have been addressed. For example, at least one airplane manufacturer specifies a missing wheel the bolt requirement so that Minimum Equipment List (MEL) dispatch relief can be provided for a limited number of cycles. As a second example, individual airplane manufacturers may specify intensified wheel load and/or test requirements to account for various tire failure modes on multi-wheeled landing gear truck and other airplane landing gear configurations. Therefore, continued airworthiness of a particular wheel/tire or wheel/brake/tire assembly is usually demonstrated by compliance with airplane manufacturer requirements and not TSO minimum standards.

(iv) Separate wheel applicable TSO and (if applicable) airplane manufacturer tests are performed with radial and bias tires due to different tire-to-wheel interface loading and resultant wheel stress pattern and deflection/clearance differences. For braked wheels, separate wheel and brake assembly tests are performed with radial and bias tires due to differences in tire energy absorption that may be encountered. Some significant differences in wheel life have been reported by one wheel and brake supplier in one case using bias tires from different tire manufacturers. Typically, however, wheel/tire, or wheel/brake/tire assembly tests, using different manufacturer bias tires have not been shown to be necessary.

(v) Wheel bearings in transport category airplane wheels should be qualified as part of the wheel assembly. Industry experience indicates that qualification of a specific manufacturer's bearing(s) in a given wheel assembly is required to assure proper performance and airworthiness. Standard part bearing assemblies are not acceptable unless performance can be demonstrated during wheel qualification testing. In response to demands for more robust wheel bearing systems, due in part to longer life tires and increased numbers of landings between wheel and bearing inspections, at least one airplane manufacturer has required qualification testing of each wheel and specific wheel bearing supplier assembly to test requirements exceeding those in TSO-C26c and typical airplane manufacturer specifications. This has required suppliers of larger wheel and brake assemblies to develop special test capabilities for qualification of specific wheel bearing assembly systems (i.e.: bearing manufacturer, grease, seals and other means of grease retention). It has been reported that roller end scoring is the most common mechanism leading to bearing failures on the airplane.

(iv) Evaluate go-around performance with normal conditions for each landing flap setting through a full range of gross weight and center of gravity conditions. Use normal cleanup procedures to the appropriate approach climb flap setting.

(v) Evaluate go-around performance with simulated engine failure conditions occurring:

(A) Just prior to go-around initiation;

(B) Just after go-around initiation; and

(C) During climb-out, both before and after initiation of altitude capture mode.

(vi) If engine-out approach/landing approval is sought by the applicant, then evaluate go-around performance initiated from an engine-out approach.

(vii) It should be demonstrated that the autopilot will command the correct speed to accomplish a go-around for the conditions in the testing described in paragraphs (v), (v), and (vi), above

(viii) Flight path control for allowing an engine failure during go-around should not require exceptional piloting skill or alertness.

(ix) Conduct go-arounds with and without, as applicable, automatic throttles, yaw damper, automatic ground spoilers, control wheel steering, and any other equipment configurations, and combinations thereof, for which the applicant is seeking certification credit. Include all sensor and instrument switching combinations.

(x) Evaluate Slow/Fast display behavior, if applicable, in conjunction with these go-around tests.

(xi) Evaluate the autopilot behavior with both series and parallel rudder (if available) configurations, particularly in conjunction with simulated engine failure tests.

(xii) Evaluate "fade-out" of parallel rudder (with simulated engine failure) during autopilot go-around mode transition to automatic altitude captures (if this feature is available).

(xiii) Verify that when automatic go-around is engaged, subsequent momentary ground contact will not cause its disengagement or a mode reversion out of go-around.

(xiv) Structure the test program such that altitude loss during the go-around maneuver can be determined as a function of height above the ground at go-around initiation. Altitude loss during the maneuver is directly proportional to the rate of descent on initiation of go-around.

(xv) Go-Around altitude loss is defined as the difference in altitude between the selection of the go-around mode and the minimum height above the ground achieved during the maneuver.

characteristics, if recovery action is taken within a reasonable period after the onset of stall warning, or other reliable warning. The autopilot must disconnect at stall warning unless proven safe beyond this point.

NOTE: Compliance with this provision need not be demonstrated if adequate means are provided to prevent such an error.

(2) Resetting the datum pressure or the selected altitude at any time during altitude capture should not result in hazardous maneuvers.

(C) The altitude hold mode should be evaluated:

- (1) During turning flight.
 - (2) During accelerating and decelerating flight.
 - (3) With engagement of the mode from climbing and descending flight conditions.
- (D) Thoroughly explore transition of VOR navigation from cruise/holding to the approach mode. Include appropriate procedures in the Airplane Flight Manual if special procedures or limitations are deemed to be necessary.

(4) Go-Around Mode.

(i) Advisory Circular 25-15 also contains some basic criteria and airspeed tolerance criteria for go-around systems that should be included in the flight evaluation. Also, Advisory Circular 120-28C, "Criteria For Approval of Category III Landing Weather Minima," contains additional go-around criteria pertinent to this flight evaluation, if the airplane is to be approved for CAT III operation.

(ii) As with the takeoff mode, the go-around roll axis control law will probably be a heading-hold or roll attitude-hold/wings-level mode and will not be addressed herein. The pitch axis control law may be an angle of attack control law system, but most modern systems will have control laws for speed control. The speed should be compatible with that used for a manually controlled go-around without guidance.

(iii) Under no circumstances should the system command a go-around speed less than $1.2 V_{SI}$ for the go-around flap setting (which equates to approximately $1.3 V_{30} + 3$ knots for the landing flap setting) or other firmly established minimum control speed (e.g., V_{MCL}) established for that particular airplane. In making this evaluation, consideration should be given to the autopilot roll axis control law and its effect on minimum control speeds; if the autopilot employs a wings-level control law, the minimum control speeds will be considerably increased over the pilot flying values that are determined with some degree of bank into the operating engine(s).

(vi) Improved wheel bearing grease and bearing preload retention means have also been introduced on some recent airplanes to increase wheel bearing longevity in the severe landing gear system environments and account for longer tire lives/ increased intervals between tire changes and inspections. Bearing wheel grease recommendations are usually specified in wheel and brake supplier CMMs. Intermixing of bearing cups/rollers/cones from different bearing manufacturers is not recommended on some large transport category airplane wheels due to different roller end scoring resistance capabilities and other often subtle differences.

c. Procedures/Method of Compliance. Due to the unique and critical nature of wheel, and wheel and brake designs, and historical airplane and personnel safety problems that have been experienced, compliance should only be approved upon successful completion of applicable TSO and tests any additional airplane manufacturer tests. Guidance should also be solicited from the original wheel and brake supplier(s)/TSO holders on any replacement part(s) to assure that continued airworthiness is not degraded.

54. TIRES - § 25.733 [RESERVED]

55. BRAKES - § 25.735

a. References:

- (1) Technical Standard Order (TSO)- C26c, "Aircraft Wheels and Wheel-Brake Assemblies, with Addendum I," dated May 18, 1984.
- (2) Advisory Circular 21-29A, "Detecting and Reporting Suspected Unapproved Parts," dated July 16, 1992.

b. Explanation.

(1) Background.

(i) The original objective of § 25.735 (formerly CAR 4b.337) evolved from a study to define a reasonable brake life for operational landings. This element is still retained in the current § 25.735(f), which requires substantiation that the brakes have the ability to absorb the energy resulting from "operational landings at maximum landing weight," and is directly related to the brake energy qualification tests of TSO-C26c. The two methods for compliance, stated in § 25.735(f), are also used in TSO-C26c for the determination of K_{Hpl} , the design landing kinetic energy rating for 100 stops at a deceleration rate of not less than 10 ft/sec^2 . The initial wear state of the brakes for the testing used to determine K_{Hpl} may be selected by the applicant. Any condition representative of service use, including new, and that satisfies TSO-C26c (or acceptable equivalent), may be used. Section 25.735(f) makes reference to "operational landings" and "in the landing configuration," which, in the context of modern transport airplane designs, could encompass a number of trailing edge flap positions and related landing speeds. The landing configuration for showing compliance with § 25.735(f) is left to the option of the applicant, but should be selected on the basis of its being the predominant landing configuration expected in operational service.

(ii) Over the years, as experience was gained in establishing takeoff and landing field lengths, it became evident that the refused takeoff was critical in determining overall brake capability and could dictate aircraft maximum gross weight for dispatch.

(iii) Investigation of an RTO overrun accident, in which 80 percent of the brakes on the subject aircraft were at or very near their completely worn state, brought about the need to consider the effect of brake wear state on: 1) energy absorption capability, and 2) stopping capability. As a result, the FAA issued a series of specific airworthiness directives for the existing fleet of transport category airplanes to establish brake wear limits such that the brakes would be capable of absorbing a maximum energy absorption RTO in the fully worn state. The FAA also initiated rulemaking to address energy absorption capability and stopping distance with fully worn brakes for future airplane types. The resulting rule, amendment 25-92, added:

(A) A requirement in § 25.735(h) for the maximum rejected takeoff kinetic energy capacity rating of the aircraft brakes to be determined with the brakes at 100 percent of the allowable wear limit;

(B) A new requirement in § 25.109(i) for the maximum kinetic energy rejected takeoff flight test demonstration to be conducted using brakes that have not more than 10 percent of their allowable wear range remaining; and

(C) A general performance requirement under § 25.101(f) that requires the accelerates-stop and landing distances of §§ 25.109 and 25.125, respectively, to be determined with all wheel brake assemblies at the fully worn limit of their allowable wear range.

(2) Approval (§ 25.735(d)). In accordance with § 21.305, a wheel and brake assembly may be approved under a Technical Standard Order (TSO) issued in accordance with Subpart O to 14 CFR Part 21; in conjunction with the type certification procedures for the airplane; or in any other manner approved by the Administrator, all of which are normally subject to flight test evaluation. (See TSO-C26c for additional guidance.)

(3) Brake tests (§ 25.735(b)). If the applicant desires to make the maximum possible use of the brakes in establishing the landing distance, and if the contribution of the brakes to the total deceleration is relatively large, the brake system should be designed to permit the application of slightly less than half the braking deceleration developed under the conditions specified in this paragraph. The following dual system is recommended: dual wheel elements (drums or disc units), transmitting elements, power sources, master cylinders, etc., connected to a single pedal on each rudder pedal, such that the failure of any single one of these would leave half the total braking capacity symmetrically disposed about the plane of symmetry of the airplane. With such a system, it should be possible to show compliance with § 25.735(b) by means of calculations based upon the test data necessary to establish the landing distance, plus the brake data calculated by the airplane manufacturer.

(4) If the system is designed so that, under conditions herein specified, appreciably less than half the total braking capacity remains, or if the remaining capacity is asymmetrically disposed, tests should be conducted to determine that half the mean deceleration may, in fact, be developed, and/or that the airplane may be safely controlled directionally while doing so. In order to obtain a minimum landing distance under § 25.125 and at the same time meet the deceleration requirements of § 25.735(b) in the event of failure of the normal brake system, it is common practice to provide an alternate brake system. When hydraulic (or pneumatic) brakes are used in the normal brake system, this alternate means usually consists of a duplicate hydraulic or pneumatic brake system and is commonly referred to as the "emergency brake system." The following items should be considered in the design of such systems:

(i) Relationship between normal and emergency brake systems. The systems for actuating the normal brake and the emergency brake should be separated so that a failure (i.e., hydraulic leakage of fluid) from one system will not render the other system inoperative. A hydraulic brake assembly may be common to both the normal and emergency brake systems if it is shown that the leakage of hydraulic fluid resulting from failure of the sealing elements in the brake assembly would not reduce the airplane's braking effectiveness below that specified in § 25.735(b).

(ii) Brake controls (§ 25.735(c)). General brake control force and operation should be noted throughout the flight test program to determine that they are satisfactory.

(iii) Brake control valves. In the normal brake systems of all airplanes, the brake valves should be of a type such that the pilots may exercise variable control of the pressure to the brakes. The foregoing provision need not necessarily apply to the emergency brake system, although obviously such a provision would be desirable. Flight tests should be conducted to determine that the normal and emergency brake systems fulfill the requirements of § 25.231.

(iv) Parking brake control (§ 25.735(d)). A demonstration should be made to determine that sufficient braking is provided with the parking brake to prevent the airplane from rolling on a paved, dry, level runway (or any suitable level hard surface) while maximum takeoff power is applied on the most critical engine, with the airplane loaded to maximum ramp weight at aft center of gravity (or the airplane loaded to a weight-s-g combination that prevents the wheels from sliding). In the case of propeller-driven airplanes, the effects of propeller wash and engine/propeller torque should also be considered in determining the critical engine. Because the resultant thrust vector can be at an angle to a propeller's axis of rotation, one engine/propeller may be more critical than its counterpart on the opposite wing, particularly if all propellers turn in the same direction.

(xvii) In addition to evaluating speed performance to the criteria shown in Table 2 of Advisory Circular 25-15, "Approval of Flight Management Systems in Transport Category Airplanes," evaluate command bar flyability, dynamics of the airplane while following the commanded guidance, initial pitch target presented during and immediately following rotation, etc.

(xviii) Evaluate takeoff pitch attitude limit, if applicable, for compatibility and command harmony.

(xix) Quantitative time history data should be derived with an on-board data system to facilitate post-flight evaluation of performance and to provide Type Inspection Report (TIR) records.

(3) Climb, Cruise, Descent, and Holding Modes.

(i) The acceptability of the autopilot system performance may be based on subjective judgment, taking into account the experience acquired from similar equipment and the general behavior of the airplane. The acceptable performance may vary according to airplane type and model.

(ii) Examination of the following modes are considered appropriate for inclusion in this section:

- | | |
|------------------------------|--------------------------|
| • Pitch Attitude Hold | • Roll Attitude Hold |
| • Vertical Speed Hold/Select | • Heading Hold/Select |
| • Altitude Hold/Select | • VOR Navigation |
| • IAS Hold/Select | • Lateral Navigation |
| • Mach Hold/Select | • Backcourse |
| • Level Change | • Non-Precision Approach |
| • Vertical Navigation | • VOR |
| • Turbulence (Penetration) | • Localizer (only) |
| • Area Navigation | |

Evaluation/approval of these modes generally will not require derivation of quantitative flight data.

(iii) Special characteristics associated with some specific modes worthy of note are:

(A) Operation of the system should not result in performance for which the pilot would be cited during a "check ride" (i.e., exceeding a speed target of 250 knots by more than 5 knots, if appropriate, during operations below 10,000 feet altitude, or overshooting a target altitude by more than 100 feet during capture of the preselected altitude).

(B) Where the automatic pilot system has the ability to acquire and maintain a preselected altitude, it should be shown in particular that:

(1) With the autopilot engaged, if the pilot fails to advance the throttles following an altitude acquisition from the descent, ensure that the airplane exhibits no hazardous

(v) Antiskid devices (§ 25.735(e)).

(A) In addition to meeting acceptable industry specifications, the installation of the antiskid device should comply with the requirements specified in paragraphs (B) and (C) below. The antiskid device and its installation will be approved for use on civil airplanes when the tests specified in the procedures section (see paragraph 55c of this AC) have been satisfactorily demonstrated.

(B) Data required.

(1) An engineering evaluation of the antiskid installation as installed on the airplane, including all necessary components, should be conducted. This analysis and complete descriptive data should be submitted to the FAA. The data should include hydraulic and electrical schematic diagrams of the installation, assembly drawings of antiskid system units, functional hazard analyses, software and hardware substantiations for electronic components, test results or stress analysis substantiating structural strength of attachments and modification of the axle or other structural members, installation drawings, recommended instructions pertaining to installation, maintenance and operation, and analysis of flight test data and results. Schematic drawings should refer to all units in the normal and emergency brake systems. The engineering evaluation should also assure that the antiskid system does not cause undesirable yaw characteristics.

(2) The engineering evaluation should account for a bounce condition wherein the wheels may leave the runway after the brakes have been applied, for a condition wherein the wheels stay on the runway but the oleos are extended (if the system utilizes landing gear oleo compression in its operation), and for a condition in which the wheels of one main gear may not be in contact with the runway for a considerable time while the wheels of the other main gear are firmly on the runway. If the antiskid installation incorporates the "landing with brake pedals depressed" feature, then this type of operation should also be considered.

(3) It should be shown that the brake cycling frequency imposed by the antiskid installation will not result in excessive loads on the landing gear.

(4) The antiskid equipment should ensure satisfactory braking action on wet and snow/ice-covered runways, as well as on dry, hard-surfaced runways, without additional antiskid adjustments.

(C) Systems requirements. The entire brake system (including both the basic brake system and the antiskid system) should conform to § 25.735. The single failure criterion of § 25.735 should be extended to include the antiskid system. The following should be considered for approval of antiskid systems:

(1) In the event of a probable malfunction within the antiskid system that would result in loss of the antiskid feature on one or more brake units, those brake units affected should automatically revert to normal braking.

(2) A means should be provided so that the pilot or copilot can readily deactivate the antiskid system to prevent loss of all braking capability due to antiskid system malfunctions.

(3) A Failure Mode and Effects Analysis (FMEA) should be provided to evaluate the effect of failures of the antiskid and associated systems (tires, wheels, brakes, etc.) on airplane safety and braking performance. For antiskid systems utilizing "locked wheel protection" circuits, this analysis should include a determination that assures mechanical faults, which could permit the affected axle to continue rotation (e.g., blown tires, broken wheel rims), will not significantly reduce the braking effectiveness of any cross-coupled wheel positions with intact wheels and tires. A tire or wheel failure that results in the loss of additional tires or wheels, either from shrapnel impingement or ensuing overload, should be considered a single failure event.

(vi) Wheel Fuse Plugs.

(A) The hazardous condition of exploding tires and wheels associated with high energy emergency stopping conditions has been greatly alleviated by the installation of wheel fuse plugs. These plugs

(C) Simulated engine failure at V_1 .

(D) Simulated engine failure at V_2+20 knots.

(E) Simulated engine failure at V_2+5 knots.

(vi) Evaluate the ability of the autopilot to command the correct speed for the conditions in the testing described in paragraphs (iii), (iv), and (v), above..

(vii) If a variable takeoff thrust derate feature is provided, perform takeoff demonstrations using up to the maximum derated thrust level for which approval is to be granted.

(viii) If an Automatic Takeoff Thrust Control System (ATTCS) is included on the airplane, evaluate its performance of intended function in conjunction with the above.

(ix) Conduct takeoffs with and without, as applicable, automatic throttles, yaw damper, automatic brake system, control wheel steering, and any other automated equipment configurations, and combinations thereof, for which the applicant is seeking certification approval. Include all sensor and instrument switching combinations.

(x) Evaluate Slow/Fast display behavior, if applicable, in conjunction with these takeoff tests.

(xi) Evaluate the autopilot behavior with both series and parallel rudder (if available) configurations, particularly in conjunction with simulated engine failure tests.

(xii) Evaluate "fade-out" of parallel rudder (with simulated engine failure) during autopilot takeoff mode transition to automatic altitude captures (if this feature is available).

(xiii) Evaluate pitch axis takeoff behavior during simultaneous heading select turns during climb-out.

(xiv) Evaluate mode transition from takeoff to other approved modes using flight director, heads-up display (HUD), and automatic pilot guidance (i.e., from pitch axis takeoff mode to IAS Hold or Vertical Speed or VNAV; from roll axis takeoff mode to Heading Select or VOR or LNAV, etc.).

(xv) Evaluate all reversion modes appropriate to the design. Most speed command takeoff modes will be fail-passive (or "fail-soft") and will probably contain reversion modes. Consult the system description, Failure Modes and Effects Analysis (FMEA), and the responsible systems engineer for definition of the appropriate evaluation. This may be accomplished in an appropriate simulator environment.

(xvi) Evaluate adequacy of mode annunciations and controls and displays associated with takeoff mode operation.

relieve the tire pressure when the wheel temperatures approach a dangerous limit. The effectiveness of these plugs in preventing hazardous tire blowouts must be demonstrated during a refused takeoff (RTO) test where the brake energy to be absorbed exceeds the maximum landing energy, but not the RTO energy, and the fuse plug must release, thereby deflating the tire(s) before blowout.

(B) An improperly designed blowout plug that allows premature or unwanted release of tire pressure during takeoff or landing could also constitute a hazardous condition. Such a situation would most probably arise during a takeoff from a quick turn-around type of airline operation. Fuse plug integrity should be demonstrated by conducting a maximum landing brake energy (which then becomes the quick turn-around chart limit for the AFM) test, which must not result in a fuse plug release.

(C) Most turbojet transport airplanes have been able to demonstrate wheel blowout plug integrity at a maximum energy level in accordance with the procedures outlined in this section. More restrictive operational limitations (e.g., runway slope and tailwind values) have been imposed to stay within this maximum energy level demonstrated for wheel blowout plug integrity. With the advent of requests to increase the maximum landing weights, and to eliminate these restrictive operational limits, it has been considered acceptable to remove the pertinent restrictions and operational limitations and substitute in their place a chase-around chart as a limitation in the FAA-approved Airplane Flight Manual (AFM). This chart will permit determining whether or not a critical energy level has been exceeded for the operating conditions of altitude, temperature, runway slope, tailwind, and landing weight. When the critical value is exceeded, a statement in the limitations section of the AFM will require that following a landing under such operating conditions, the airplane must remain on the ground a certain length of time prior to taxiing out for takeoff. This length of time will be the time to reach peak wheel temperatures (appropriate to the blowout plug location), plus 15 minutes. In lieu of the AFM fuse plug limitation chart, an alternate method for determining limit operational landing energy, such as a brake temperature limit, can be considered for approval.

(D) The wear level of the brakes used for the chase-around chart discussed in the preceding paragraph should be selected by the applicant. Service experience indicates that the conservatism contained in the method of determining the turnaround time limits is adequate to allow these limits to be determined using new brakes.*

(E) In the case where it is possible to demonstrate wheel blowout plug integrity at a maximum energy level in accordance with the procedures in this section and without imposing certain restrictions on the operational limitations (e.g., runway slope and tailwind values), it is not considered necessary to incorporate the chase-around chart and pertinent statement in the limitations section of the AFM. Where restrictions are necessary, a pertinent statement and reference to the chase-around chart could be included in the limitations section of the AFM. The chart may be in Section 4, or in an appendix to the AFM.

(vii) Replacement and Modified Brakes.

(A) In order to establish aircraft landing and RTO certification performance levels for a replacement brake or a modified brake, measured accelerate-stop tests, and functional flight tests (landing distance), may be required, depending upon an evaluation of the individual merits of each brake system change. The type and magnitude of flight tests required will depend on whether or not a requested change involves a change of change of heat sink and/or torque requirements of the original certificated brake. A review of the change by the cognizant Aircraft Certification Office (ACO) for the type certificate holder is necessary, since original landing gear designs are based on structural analysis, which could be adversely affected by a brake system change. In addition, such tests will also depend on whether or not an increase in the FAA certificated performance level is desired by the applicant.

(B) Changes to the friction couple elements (rotors and stators) are generally considered to be a major change, requiring the testing described in paragraph 55c(1), unless it can be shown that the change cannot affect the airplane stopping performance, brake energy absorption characteristics, or continued airworthiness. Historically, continued airworthiness considerations include such items as landing gear system/airplane vibration control, braking feel, landing gear system compatibilities etc.

(C) Changes to a brake by a manufacturer other than the original TSO holder might be considered to be a minor change, as long as the changes are not to the friction couple elements, and the proposed

(X) The controls, indicators, and warnings should be designed to minimize crew errors. Mode and system malfunction indications should be presented in a manner compatible with the procedures and assigned-tasks of the flightcrew. The indications should be grouped in a logical and consistent manner, and be visible under all lighting conditions.

(xi) The means provided to comply with § 25.1329(f) should also give an appropriate indication when there is an inadvertent change or disengagement of a mode.

(2) Takeoff Mode.

(i) Advisory Circular 25-15, "Approval of Flight Management Systems in Transport Category Airplanes," contains some basic criteria and airspeed tolerance criteria that should be included in the flight evaluation of systems containing takeoff guidance. Additional testing considerations, which should be considered for inclusion in the flight test plan, are presented in paragraphs (ii) through (xix), below.

(ii) The roll axis control law will probably be a heading hold or roll attitude-hold/wings-level mode. The performance of the roll axis control function is considered to be obvious during the normal course of flight testing and, therefore, is not addressed with specific test requirements herein. The pitch axis control law discussed below represents a system providing computed command guidance (flight director, HUD, and automatic pilot after liftoff) representing the reference speed to be flown during second segment climb-out.

(iii) For a normal all-engines-operating (AEO) takeoff, the reference speed should be the normal AEO initial takeoff climb speed selected by the applicant (typically V_2+10 knots). In the event that an engine failure occurs during the takeoff maneuver, at an airspeed greater than V_1 , the reference speed should be:

(A) V_2 if an engine failure occurs prior to V_2 .

(B) Existing speed if engine failure occurs between V_2 and the AEO initial climb speed.

(C) The AEO initial takeoff climb speed for all other conditions, if appropriate.

(iv) Evaluate takeoff performance with different flap settings and different loading conditions (gross weight and center of gravity) to cover the various flight conditions. Use normal rotation and cleanup procedures unless noted otherwise.

(v) Evaluate abnormal/simulated failure conditions including:

(A) Late rotation

(B) Early rotation

commensurate with the type of operation. Criteria and requirements for flight must consider the applicant's engineering analysis. The combination of analysis and flight evaluation will form the whole of the certification requirement and, as such, must be in harmony and provide full evaluation. The flight evaluations supplement the analysis as required in both the representative operating conditions of the airplane and for critical operating conditions. The critical conditions are determined from analysis of the total FGCS/airplane modes of operation and configuration conditions.

(ii) The requirement for demonstrating safe operation normally should include induced failures during flight. The requirement for failure demonstrations is also an outgrowth of the analysis submitted by the applicant and is a result of the particular design being evaluated (e.g., consideration should be made for multiple channel systems specifically designed to be self-adaptive to failure conditions).

(iii) The automatic pilot system should be installed and adjusted so that the system tolerances established during certification tests can be maintained in normal operation. This may be assured by conducting flight tests at the extremes of the tolerances. Those tests conducted to determine that the automatic pilot system will adequately control the airplane should establish the lower limit, and those tests to determine that the automatic pilot will not impose dangerous loads or deviations from the flight path should be conducted at the upper limit. Appropriate airplane loading to produce the critical results should be used.

(iv) Means must be provided to indicate to the flightcrew the current mode of operation and any modes armed by the pilot. Selector switch position is not acceptable as a means of indication.

(v) The system should be demonstrated to perform its intended function in all configurations in which it may be used throughout all appropriate maneuvers and environmental conditions, including turbulence, unless an appropriate operating limitation or statement is included in the Airplane Flight Manual. All maneuvers should be accomplished smoothly, accurately, and without sustained nuisance oscillation.

(vi) In addition to performance of intended function of each mode examined, the automatic pilot system should cause no sustained nuisance oscillations, undue control activity, or sudden large attitude changes, especially when configuration or power changes are taking place.

(vii) When automatic functions are provided that may be used with these systems (e.g., automatic throttle control or yaw damper, etc.), and use of the system is permitted with any of these functions inoperative, the system should comply with these flight test requirements with these additional functions operative and inoperative.

(viii) In addition to the quick release controls of § 25.1329(d), in order to show compliance with § 25.1309, an alternative means of disengagement for the automatic pilot should be provided. It should be readily accessible in flight.

(ix) It should be possible to disengage the automatic pilot system at any time without unacceptable out-of-trim forces.

changes) cannot affect the airplane stopping performance, brake energy absorption, vibration, and/or thermal control characteristics, and continued airworthiness of the airplane. In certain circumstances, the change to a steel rotor by a manufacturer other than the original TSO holder may be considered to be a minor change, as discussed in paragraph 55c(5)(ii).

c. Procedures. The extent of the flight test requirements, except new airplane certification, may vary depending upon an evaluation of the individual merits of each airplane brake system change, and whether or not an increase in the FAA certified performance level is desired by the applicant. Past experience has proven that dynamometer tests alone are not considered adequate in determining compliance with this requirement. Flight test procedures for new, replacement, and modified brakes are categorized as follows:

(1) Basic new airplane certification -- complete new design where no airplane performance data exist.

(i) Tests required.

(A) For complete analysis, at least six rejected takeoffs and six landings will normally be necessary.

(1) Six landings must be conducted on the same wheels, tires, and brakes.

(2) All tests should be conducted with engines trimmed to the high side of the normal idle range (if applicable).

(3) For airplanes whose certification basis includes Amendment 25-92, § 25.101(i) requires the stopping distance portions of the accelerate-stop and landing distances to be determined with all the aircraft brake assemblies in the fully worn state. An acceptable means of compliance with this requirement is to accomplish the flight test braking tests with less than fully worn brakes, and then correct the test results using dynamometer test data determined with fully worn brakes. It should be substantiated that the dynamometer test methodology employed, and analytical modeling of the airplane/runway system, are representative of actual conditions.*

(B) Additional tests may be necessary for each airplane configuration change (i.e., takeoff and/or landing flaps, nose wheel brakes, antiskid devices inoperative, deactivation of wheel brakes, etc.).

(C) Brake system response evaluation including braking during taxiing (see paragraph 30b(2)(i).

(D) Parking brake adequacy (see paragraph 55c(1)(iii)),

(E) Alternate braking system stops.

(F) Wheel fuse plug evaluation (see paragraph 55c(7)).

(G) Antiskid compatibility on a wet runway.

(H) Automatic gear retraction braking system on airplanes so equipped.

(ii) Maximum rejected takeoff (RTO) energy will be established by conducting an RTO at the maximum brake energy level for which the airplane will be certified. Fires on or around the landing gear are acceptable if the fires can be allowed to burn during the first 5 minutes after the airplane comes to a stop, before extinguishers are required to maintain the safety of the airplane. The condition of the tires, wheels, and brakes can be such that the airplane would require maintenance prior to removal from the runway. A deceleration rate must be maintained during this test that is consistent with the values used by performance scheduling. Tire or wheel explosions are not acceptable. Tire fuse plug releases may occur late in the RTO run, provided directional control is not compromised. The resulting distance (with fuse plugs blown during the RTO run) is to be included in the data used to establish AFM performance, only if it is longer than the data obtained with normal full braking configuration.

* (A) For airplanes whose certification basis includes Amendment 25-92, the maximum brake energy absorption level must be determined for an airplane with all wheel brake assemblies in the fully worn state. In accordance with § 25.1099(i), the flight test maximum energy RTO demonstration must be accomplished with all brake assemblies within 10 percent of their allowable wear limit (i.e., at least 90 percent worn). Dynamometer testing, when used to extend the flight test results to determine the maximum energy absorption capability of the brakes in the fully worn state (i.e., 100 percent worn), should be substantiated as being representative of actual airplane and runway conditions. The fully worn limit is defined as the amount of wear allowed before the brake must be removed from the airplane for overhaul. The allowable wear should be defined in terms of a linear dimension in the axial direction, which is typically determined by measuring the wear pin extension.

(B) The maximum energy RTO demonstration should be preceded by at least a three mile taxi, with at least three intermediate full stops, using normal braking and with all engines operating.

(C) Landings are not an acceptable means to conduct maximum energy RTO demonstrations. Though permitted in the past, service experience has shown that methods utilized to predict brake and tire temperature increases that would have occurred during taxi and acceleration were not able to accurately account for the associated energy increments.

(iii) The ability of the parking brake to prevent the airplane from rolling should be demonstrated on a paved, dry, level runway (or any suitable level hard surface) with takeoff power applied on the critical engine using the following test procedure:

(A) The airplane should be loaded to its maximum takeoff weight (or the airplane loaded to a weight-c.g. combination that prevents the wheels from sliding) with the tires inflated to the normal pressure for that weight, the flaps should be retracted, the control surfaces centered, and the parking brake set.

(B) Apply takeoff power to the critical engine with the other engine(s) at idle.

(C) Compliance with the requirements of § 25.735(d) is shown if the wheels do not rotate; this is best observed by painting a white radial stripe(s) on the wheels. The airplane may skip, the tread may shear, or the tire may slip on the wheel, but the parking brake must prevent the wheels from rotating. Skidding of the tires is acceptable.

(2) Addition of New or Modified Brake Design.

(i) This item concerns the addition of a new or highly modified brake design to an existing type certificated airplane for which FAA-approved braking performance test data exists, either for performance credit, or to the existing performance level. A highly modified brake is defined as one that contains new or modified parts that may cause a significant variance in brake kinetic energy absorption characteristics, airplane stopping performance, or continued airworthiness of the airplane. Examples are: significant change in rotor and/or stator lining compound or area, number of stages, piston area, reduction in heat sink weight, changes in total number of friction faces and elements, change in brake geometry (friction, radius, friction area), fuse plug relocation or change in release temperature, heat shield changes that would affect the temperature profile of the wheel and/or fuse plugs, or seal changes.

(ii) Tests Required.

(A) For improved performance credit, all applicable portions of paragraph 55c(1).

(B) For equivalent performance, a sufficient number of conditions to verify the existing approved performance levels (RTO and landing). Consideration should be given to verification of fuse plugs, performance verification at appropriate energy levels, and configuration differences, including antiskid on and off. Taxi tests to ensure that ground handling, maneuvering, and brake sensitivity are satisfactory should be conducted. At least two braking stops, one at heavy weight and one at light weight, should be conducted on a wet runway to verify brake and antiskid system compatibility.

179. PITOT HEAT INDICATION SYSTEMS - § 25.1326. [RESERVED]

180. MAGNETIC DIRECTION INDICATOR - § 25.1327. [RESERVED]

181. AUTOMATIC PILOT SYSTEM - § 25.1329.

a. Explanation.

(1) On most modern airplane installations, the autopilot and flight director are integrated into a single computer, use common control laws, and are identified as a Flight Guidance and Control System (FGCS). Although the Head-Up Display (HUD) system, if installed, is generally a separate system, evaluation of its modes of operation would be identical to a flight director system. For these reasons, the systems flight test evaluation criteria are combined herein.

(2) The system pertains to equipment or combinations of equipment that provide the means for airplane control and guidance, whether by means of pilot supervised automatic systems or through guidance to the pilot for manual control. This includes sensors, computers, power supplies, servomotors/actuators, and associated wiring.

(3) The system should include any indications and controllers necessary for the pilot to manage and supervise the system.

(4) Additional guidance material related to autopilot/FGCS operation, testing, and approval is contained in the following FAA Advisory Circulars:

(i) Advisory Circular 25-15, "Approval of Flight Management Systems in Transport Category Airplanes," dated November 20, 1989.

(ii) Advisory Circular 25-1329-1A, "Automatic Pilot Systems Approval," dated July 8, 1968.

(iii) Advisory Circular 91-16, "Category II Operations - General Aviation Airplanes," dated August 7, 1967.

(iv) Advisory Circular 120-28C, "Criteria for Approval of Category III Landing Weather Minima," dated March 9, 1984.

(v) Advisory Circular 120-29, "Criteria for Approving Category I and Category II Landing Minima for FAR 121 Operators," dated September 25, 1970.

b. Procedures.

(1) General.

(i) The evaluation of an FGCS should primarily concentrate on system intended function and safe operation. In certain areas, degree of performance will require specific criteria

with data processing and filtering. The airspeed indicating system should not have a lag in excess of 3 knots at the V_1 speed during any takeoff condition. Furthermore, if airspeed lag causes an increase of more than 100 ft. in takeoff or accelerate-stop distances, a lag correction must be applied to the airspeed indicating system. Airspeed lag should be determined by one of the following methods:

- (i) Conduct ground acceleration tests for a range of airplane gross weights to calibrate Indicated Airspeed (IAS) at the cockpit display against the reference Calibrated Airspeed. Determine airspeed lag from the calibration data by comparing the cockpit displayed airspeed with the reference calibration speed for a given gross weight and V_1 speed.
- (ii) Determine airspeed lag by analysis using a computer program suitable for AFM development. Compute takeoffs for a range of gross weights to determine the acceleration at V_1 . Calculate airspeed lag at V_1 for a corresponding acceleration and a known time lag due to data processing and filtering. The analysis should also consider other sources of airspeed lag as appropriate, such as the pneumatic lag in the pressure lines for the pitot and static sources.
- (6) Having established the calibration data, one acceptable method of adjusting for airspeed lag is to apply corrections directly in the ADC data processing to result in a lag-corrected airspeed at the cockpit display. Another would be to include an airspeed lag correction in the takeoff ground speed calibration of Indicated vs. Calibrated Airspeeds in the AFM. A single airspeed lag increment can be developed as the correction for the range of gross weights and corresponding accelerations at V_1 . This increment, when applied to the calibration, must result in no more than a 100 ft. increase in takeoff or accelerate-stop distances due to airspeed lag for any takeoff condition. A more accurate correction would result from presenting airspeed lag as a function of airplane acceleration based on the calibration data. If acceleration data are available in the ADC, a real time correction for lag during the takeoff can be applied in the data processing.

178. STATIC PRESSURE SYSTEMS - § 25.1325(d) and (e).

a. Explanation

- (1) If the altimeter installation is of the pressure type, its operation will be affected by any error that exists in the measurement of the static air pressure. Since the accuracy of the altimeter is of utmost importance, the static air vent system should be calibrated. If separate or alternate vent systems are employed for the altimeter and airspeed indicator, separate calibrations are required. Where the altimeter, rate of climb indicator, and airspeed indicators are vented to the same static systems, the altimeter calibration may be made in conjunction with the airspeed calibrations.
- (2) The theoretical relationship between airspeed error and altimeter error may be used to derive an altimeter calibration from the airspeed calibration if both use the same static vent, provided the total head sensing installation is designed to provide true readings over the angle of attack range involved.

b. Procedures. None.

(C) For extended performance, a sufficient number of conditions to define the extended line and determine equivalency to the existing performance levels. Consideration should be given to the items in paragraph (B), above.

(iii) Definitions.

- (A) Improved performance implies an increase in the μ versus energy level for the desired operation(s) and may be requested for landing, RTO's, or a specific configuration such as antiskid "on" only.
 - (B) Equivalent performance implies that sufficient data will be obtained to verify that the performance level for the desired change is equal to or better than the existing performance levels. The change may be for the purpose of changing the c.g. envelope, or for airplane configuration changes (such as flap angles), and may apply to specific operations (such as landings).
 - (C) Extended performance implies that the existing certification μ versus energy line will be extended to establish the braking force level for a proposed change, such as gross weight or the maximum desired energy level, and may be applied to a specific operation (such as landing only).
- (3) Addition of new, or changes to, antiskid systems that may affect airplane performance (e.g., new antiskid system, or a change from coupled to individual wheel control). A sufficient number of airplane performance tests and/or functional tests should be conducted to verify existing approved performance antiskid "on" levels. In the event an increase of braking performance is desired, full airplane performance testing is required.
 - (4) Fuse plug modification.
 - (i) Airplane tests for changes to the fuse plugs should be evaluated on a case-by-case basis. While airplane tests are required to establish the initial fuse-plug-no-melt, energy, minor changes to fuse plugs, or wheel designs may be validated by a back-to-back dynamometer comparison of old versus new designs, provided it is acceptable to the cognizant FAA ACO.
 - (ii) Airplane tests should be required when a significant change of wheel design and/or redesign or relocation of thermal or pressure fuse plugs is made.
 - (A) One airplane test should be conducted to show that the fuse plugs will release when excessive energies are absorbed.
 - (B) Another airplane test is required to verify the maximum kinetic energy at which fuse plugs will not release (fuse plug substantiation). Dynamometer tests are not adequate for this test.
- (5) Minor/Major Changes.
 - (i) Minor brake changes that do not affect airplane braking performance may require functional landings. This may be required to verify airplane-pilot-brake-antiskid combination compatibility. Normally, five non-instrumented, functional landings are considered sufficient to verify this compatibility. Examples of minor changes might include structural improvements (increased fatigue life), adjuster/retactor modifications, material and process specifications changes for structural components, and modified heat-sink relief slots (steel brakes). Examples of other minor changes that do not require functional landings are paint/corrosion changes, changes to bleed ports or lube fittings, revised over inflation devices, metal repair, and salvage procedure. Such changes could be considered to be minor whether they are proposed by the original manufacturer who holds the TSO authorization, or by another manufacturer seeking to produce replacement parts.
 - (ii) Changes to heat sink friction couple elements are to be considered major changes, unless the applicant can provide evidence that changes are minor. Based upon experience, thicker friction material or heavier heatsink elements are usually acceptable as minor changes in steel brakes. Thicker or heavier heat sink elements in carbon brakes may require additional laboratory and/or airplane testing to assess brake performances and continued airworthiness. Major changes are subject to extensive airplane testing, unless it can be shown that the change cannot affect the airplane stopping performance, brake energy absorption characteristics, and continued airworthiness. In this regard, the original manufacturer of the wheel/brake assembly who holds the TSO authorization, and the Type

Certificate holder who is knowledgeable with respect to such items as landing gear design assumptions and airplane braking system history, may possess data sufficient to show that such changes could be considered to be minor (i.e., performance would not be affected). In contrast, an applicant other than the original manufacturer who wishes to produce replacement rotors or stators may not have access to or have established developmental or other test data required to show that performance, braking energy capacities, braking system compatibilities, or overall continued airworthiness safeguards have been addressed. Due to the complex nature of the friction surfaces and airplane braking system interfaces, proposed replacement stators/rotors by an applicant other than the original manufacturer(s) should always be considered a major change.

(iii) It is considered very difficult to determine 100 percent identicality. This is particularly true for brake friction rubbing components (e.g., linings in cups, linings sintered to plates, steels used in steel brakes, and carbon discs in carbon brakes). A finding of equivalency based upon physical documentation and dynamometer testing may not be possible or practical due to friction material complexities and/or the extent of dynamometer testing required.

(iv) Due to the complexities associated with aircraft brake friction couples, industry and authorities have generally discouraged mixing of friction components from various suppliers within the same brake or mixing wheel and brake assemblies from different manufacturers on the same airplane. Typically, the manufacturers of large transport category airplanes have confined the use of specific wheel and brake suppliers' assemblies to specific airplanes through approved equipment lists. While multiple wheel and brake suppliers (i.e., multiple original TSO holders) are often selected to provide wheel and brake assemblies on a specific airplane model, intermixing of wheel and brake assemblies has been discouraged to avoid potential problems such as unequal energy sharing, unfavorable dynamic cross coupling between brakes, landing gear, and the airplane; degradation of vibration and/or thermal controls; unique brake control system tuning requirements for each wheel and brake assembly, etc.

(v) The FAA has, however, approved the use of replacement steel rotors. The following protocol for steel rotor equivalency findings has been updated to include brake wear and wear pattern assessments to assure that the worn brake capability of the original manufacturer's wheel and brake assembly is not degraded by a replacement steel rotor(s). The following criteria and evaluations represent protocol for replacement steel rotors to be considered as a minor change:

- (A) a very close correlation between the original part and the proposed replacement part;
 - (B) considerable and satisfactory prior manufacturing and in-service experience with a similar replacement part;
 - (C) a reasonable plan of test for completion of the dynamometer portion of the test program;
 - (D) successful completion of the dynamometer testing; and
 - (E) as a minimum, successful completion of a series of functional landings on the airplane.
- (vi) The necessity of conducting maximum energy RTO testing and other brake system tests on the airplane will depend upon the outcome of the above evaluations and worn brake RTO airplane test experiences (if applicable).
- (vii) If intermixing of replacement steel rotors with the original manufacturer's steel rotors is proposed, the applicant must propose an airplane test evaluation plan to the FAA that provides data to guide a worn brake rejected-take-off equivalency assessment. If the applicant cannot provide evidence on similar overall wear and wear patterns from the new to worn condition for the proposed mixing configuration(s), intermixing will not be permitted in order to assure that the worn brake rejected-take-off rating and approved wear limit of the original TSO holders' wheel and brake assembly is not jeopardized.

(viii) The dynamometer test plan, and, if applicable, the overall wear and wear pattern test plan, must include:

(2) Speed course: The airspeed, power, and altitude should be stabilized before entering the speed course. Constant airspeed should be maintained during each run. The runs should be made in both directions on reciprocal headings for each speed over the speed course. The following data should be recorded:

- (i) Time of day at beginning of run.
 - (ii) Time to make run.
 - (iii) Pressure altitude.
 - (iv) Ambient air temperature.
 - (v) Airspeed at several intervals during run.
 - (vi) Wing flap position.
 - (vii) Landing gear position.
 - (viii) Course distance.
- (3) Reference airspeed system: Stabilized runs at the test speeds listed in this paragraph should be made. The airspeed from the airplane's airspeed system and the reference airspeed system should be read simultaneously. The following data should be recorded:

- (i) Time of day.
- (ii) Airplane's indicated airspeed.
- (iii) Reference indicated airspeed.
- (iv) Pressure altitude.
- (v) Ambient air temperature.
- (vi) Wing flap position.
- (vii) Landing gear position.
- (4) Other acceptable airspeed calibration methods. Stabilized flight runs at the test speeds should be made, and the necessary data recorded, to establish the airplane's airspeed system error and the configuration of the airplane. Calibration methods may also include airspeed boom, static trailing cone, and radar range.
- (5) The procedures presented in this paragraph pertain to the calibration of the airspeed indicating system during takeoff ground acceleration. In particular, airplanes with electronic instruments in the cockpit must account for the airspeed lag at the cockpit display associated

run must determine the "system error" which is the relation between indicated and calibrated airspeeds. The system error is the sum of the pneumatic lag in the pressure lines, airspeed lag due to time lags in processing the data, and static source, position error.

(A) Airspeed lag must be measured during ground acceleration tests or determined by analysis. Increments should be developed for a range of airplane gross weights considering airspeed lag at V_1 and the associated increase in accelerate-stop and takeoff distances due to lag. The error due to lag in the airspeed indicating system during ground acceleration should not be greater than 3.0 knots throughout the takeoff operating envelope of the airplane. Furthermore, an increase in the takeoff distance or the accelerate-stop distance as a result of airspeed lag should not exceed 100 ft. The 3 knots limitation is intended to establish the maximum acceptable systematic error. Even though the lag may be within the 3 knots limit, an airspeed correction may be required to stay within the 100 ft. of increased distance.

(B) Corrections may be applied directly in the ADC or they may be introduced via the ground airspeed calibration provided in the Airplane Flight Manual (AFM). If corrections are applied directly in the ADC, it is possible to display calibrated airspeed in the cockpit. Furthermore, if acceleration data are input, the airspeed error can be computed and accounted for in real time, assuming the time lag is known. The alternative would be to use an airspeed lag increment derived from calibration tests that would represent a range of conditions within the takeoff envelope. After correction, an increase in distance due to lag should be less than 100 ft throughout the takeoff envelope, whether applied in the ADC or AFM. Consideration should be given to short field, lighter weight takeoffs (higher acceleration), as well as maximum weight and higher V_1 speeds, in deriving the increment.

(2) Configuration. Airspeed calibration tests should be conducted in the following configurations:

- (i) Weight - between maximum takeoff and maximum landing.
- (ii) C. G. position - optional.
- (iii) Takeoff configuration(s) - ground roll.
- (iv) Wing flaps and landing gear - all combinations of positions used to show compliance with the takeoff, climb, and landing requirements of 14 CFR part 25.
- (v) Thrust - as required.

b. Procedures.

(1) Any one or any desired combination of the procedures in subparagraphs (2) through (4) of this paragraph may be used for calibrating the airspeed indicating system. The airspeed should be measured or determined simultaneously from the airplane's system and the reference system during stabilized runs for at least five speeds spaced throughout the speed range, the lowest not to exceed $1.3 V_S$. The highest speed should not exceed V_{MO}/M_{MO} . The speed spread between the test speeds should be limited to 10 knots from V_S to $1.6 V_S$ or placard speed, and 20 knots from $1.6 V_S$ to V_{MO} .

(A) TSO Minimum Standard Performance Demonstration. The wheel and brake assembly containing the applicant's proposed steel rotor configuration must successfully demonstrate compliance with the braking and structural tests of the applicable TSO, and

(B) Compliance with:

- (1) the airplane-manufacturer-specified requirements, or
 - (2) the alternate procedures specified below:
- (ix) Alternate Procedures (steel rotors only).

(A) Energy and Torque Capacity Tests. A series of tests (not only one) may be necessary to demonstrate, in back-to-back tests, that brake energy absorption and torque and pressure vs. time profiles are equivalent. All friction components and structures should be in the new condition to obtain credit for this test. If rebuilt or in-service components other than these fail during testing, it should be realized that the results of the test(s) may be questionable. Suspect tests will be carefully reviewed by the FAA, and may require retesting. Prior to test, the applicant should carefully document wheel hardness and wheel drive, torque tube spline, piston/bushing assembly conditions to assure comparable test articles are being used. The same tire size and ply rating, manufacturer, tire condition, radial load, and rolling radius should be used in each test. Test machines and test conditions must be consistent from test to test, including test brake, wheel and tire break-in stop histories, brake pressure onset rates (psig/sec), maximum pressures, initial brakes-on-speeds, flywheel inertias, etc., to assure consistent test control. Artificial cooling is not permitted during or subsequent to the test until wheel and piston housing temperatures have peaked.

(B) The initial kinetic energy level for this series of tests will be at the discretion of the applicant. For each succeeding run, the KE will be increased by approximately 5 percent over the previous run, until the ultimate KE level is determined (i.e., points at which pistons are about to exit bores or flywheel deceleration falls below 3 ft/sec^2 (½ of the TSO RTO minimum average deceleration requirement)). The deceleration reported by the applicant should be based upon distance (and not time) in accordance with the following formula:

Distance Averaged Deceleration =

$$\frac{((\text{Initial brakes-on speed})^2 - (\text{Final brakes-on-speed})^2) / 2}{(\text{braked flywheel distance})}$$

(1) A minimum of two runs at this ultimate energy level must be conducted on the original manufacturer's wheel and brake assembly for baselines. These test runs must show similar results. Maximum braking force pressure must be applied during the tests. Fuse plug releases in any tests must demonstrate safe release of approved nitrogen-air mixtures.

(2) A minimum of two test runs at the ultimate energy level must then be conducted on the applicant's proposed wheel and brake assembly (i.e., a back-to-back demonstration of the two manufacturers brakes). Tests must show similar brake energy absorption, torque, and thermal performance capabilities, and torque and pressure versus time profiles, while demonstrating sealing and structural integrity comparable to the original manufacturer's wheel and brake assembly.

(C) Worn Brake RTO Capability. Worn brake RTO capability for the proposed wheel and brake assembly with steel rotor replacement configuration(s), and at the wear pin limit(s) proposed by the applicant, must be established during dynamometer test(s). The test brake energy absorption criteria, torque performance, and pass/fail requirements should be requested of the airplane manufacturer to provide supporting evidence that the worn brake RTO capability is equivalent to that achieved with the original TSO holder's wheel and brake assembly(ies). If unavailable, the applicant should propose a worn brake RTO test plan similar to that in paragraph 55c(1) for new brakes. The applicant should also propose to the FAA the method which will be followed by the applicant to verify that the worn brake RTO capability of in-service worn brakes with replacement rotors is equivalent to the capability established in initial dynamometer test(s) in accordance with paragraph 55(c)(1)(i)(A) of this AC.

(D) Intermixing of steel rotor assemblies produced by two manufacturers will not be allowed until it can be demonstrated that wear patterns of the intermixed assembly(ies), through a determined number of in-

service touts, does not jeopardize the worn brake RTO capabilities of the original or the replacement wheel and brake assemblies. Since dynamometer testing is generally impractical, the applicant should forward to the FAA an in-service plan to survey wear and wear patterns from a sampling of worn in-service brakes containing steel rollers from the original manufacturer only, from the applicant only, and from an in-service brake(s). Since the original manufacturer's brake often contains second, and possibly third four round steel rollers, at least two touts of in-service evaluation with replacement steel rollers may be required to assess equivalence. This data will provide guidance for approved worn brake RTO wear limits for brakes containing replacement rollers.

(E) Torque/pressure ratio-profiles. A torque/pressure ratio test plan and tests are required to demonstrate equivalent gain performances over a range of test speeds and test pressures. The test article conditions, break-in conditions and procedures, test speed range, and test pressure matrix, used to evaluate both the original and applicant wheel and brake assemblies, must be the same with tests conducted in the same order. The results of these tests will provide guidance for braking system control compatibility assessments.

(F) As a minimum, the five functional landings described in paragraph 55(c)(5)(D), above, are also a required part of this approval procedure.

(G) Continued Airworthiness. Past history with friction material couples has indicated the necessity of ongoing monitoring (by dynamometer test) of RTO capability to assure that the AFM limitations are not exceeded over the life of airplane programs. For larger transport category commercial airplanes, it has been shown that these monitoring plans have complemented the detection and correction of unacceptable deviations. The applicant must provide the FAA with a quality plan to demonstrate that the RTO capability of the friction couple is maintained with replacement steel rotors over time.

(6) Auto-braking. The following are required for auto-braking installations based on function, non-hazard, and non-interference on airplanes for which performance without auto-braking has been determined:

(i) The system design must be evaluated for integrity and non-hazard, including the probability and consequence of insidious failure of critical components. No single failure may compromise non-automatic braking of the airplane.

(ii) Positive indication of whether the system is operative or inoperative must be provided.

(iii) For each auto-brake setting for which approval is desired, the ground roll distance from touchdown to stop must be determined for the landing weights and altitudes within the envelope for which approval is desired. In determining ground roll distance, the performance must be established without reverse thrust, and any adverse effect upon performance associated with the use of reverse thrust must be established and accounted for. Repeatability of initial application should be shown by comparing the onset of braking for each of the range of settings. Landing ground roll distance data determined as prescribed herein must be presented in the performance information section of the FAA-approved AFM as guidance material.

If the auto-braking system is to be approved for wet runways, auto-brake compatibility on a wet runway should be demonstrated. These tests may be limited to the highest auto-brake setting, where antiskid activity is expected to occur throughout the stop, and a single lower setting, where antiskid activity is expected to occur for only a portion of the stop. AFM stopping distances for other settings can be computed based on predicted wet-runway friction coefficients and do not require demonstrations on wet runways of all auto-brake settings. Landing ground roll distance data determined on a wet runway should also be presented in the AFM for all operating modes of the system. This information is considered necessary so that the pilot can readily compare the automatic brake stopping distance and the actual runway length available, so as to assess the effect of the use of the automatic braking system on the runway margin provided by the factored field length.

(iv) Automatic braking systems that are to be approved for use during rejected takeoff conditions should provide only a single brake setting that provides maximum braking. In the event that automatic brakes result in a longer rejected takeoff distance than manual brakes, the FAA-approved AFM must present the longer rejected takeoff distance.

(v) Procedures describing how the automatic braking system was used during the FAA evaluation and in determining the landing ground roll distance of paragraph 55c(6)(iii) must be presented in the AFM.

Section 2. INSTRUMENTS: INSTALLATION

175. ARRANGEMENT AND VISIBILITY - § 25.1321. [RESERVED]

176. WARNING, CAUTION, AND ADVISORY LIGHTS - § 25.1322. [RESERVED]

177. AIRSPEED INDICATING SYSTEM - § 25.1323.

a. Explanation

(1) Methods. Unless a calibrated reference system is provided, the airspeed system should be calibrated throughout as wide a range as necessary to cover the intended flight tests. The procedures of this section are for the purpose of showing compliance with § 25.1323(b) and are not intended to cover the speed range of the flight tests. If an alternate airspeed indicating system is provided, it should be calibrated. The airspeed indicating system should be calibrated in accordance with the following methods:

(i) The tests should be conducted in stabilized flight at airspeeds throughout the speed range for the airplane configurations to be tested. The airplane's airspeed system should be calibrated against a reference airspeed system or a groundspeed course.

(ii) A reference airspeed system should consist of either of the following:

(A) An airspeed impact pressure and static pressure measurement device (or devices) that are free from error due to airplane angular changes relative to the direction of the free stream or due to slipstream variation resulting from changes in airplane configuration or power. In addition, the device or devices should have a known calibration error when located in the free stream; or

(B) Any other acceptable airspeed calibration method (e.g., the altimeter method of airspeed calibration).

(iii) When establishing the airplane's true airspeed by means of the groundspeed course, flight between the two reference points should be made at constant airspeed in two successive runs in opposite directions to eliminate the effect of wind. The runs should be made only in stable wind. The time to make the runs should be obtained by means of some calibrated device. The speed runs should not be made nearer the ground surface than a wing span's length.

(iv) If an alternate system is provided, it may be calibrated against either the reference system or the airplane's system.

(v) Airspeed Lag. With the advent of electronic instruments in the cockpit, the pneumatic signals from the pitot and static sources are processed and digitized in the Air Data Computer (ADC) and then filtered and transported to the cockpit display. As a result of the data processing and filtering, the associated time lag, and, consequently, airspeed lag at the cockpit display, can be an important consideration in the airspeed indicating system calibration during ground acceleration. As stated in § 25.1323(d), the calibration for an accelerated takeoff ground

(4) Verify that adequate warnings are provided of unsafe conditions, and that these warnings enable the flightcrew to take appropriate corrective action with a minimum of error.

(5) For probable operating combinations of required electrical installations, verify that power is provided for probable durations:

- (i) Under normal conditions;
- (ii) After failure of any one generator, converter, or storage device;
- (iii) After failure of one engine on a two-engine airplane; and
- (iv) after failure of two engines on airplanes with three or more engines.

(6) For probable operating combinations of required electrical installations, which must be provided with an alternate source of power, verify that power is provided for probable durations after failure of any one power system.

(vi) Compliance with operational requirements regarding landing runway length will continue to be predicated on landing distance data established using the requirements of § 25.125 for non-automatic braking.

(7) Wheel Fuse Plug Design.

(i) Wheel fuse plug integrity should be substantiated during braking tests where the energy level simulates the maximum landing energy. It should be demonstrated that the wheel fuse plugs will remain intact, and that unwanted releases do not occur. One acceptable method to determine this is as follows:

- (A) Set engine idle thrust at the maximum value specified (if applicable).
- (B) Taxi at least three miles (normal braking, at least three intermediate stops, and all engines operating).
- (C) Conduct accelerate-stop test at maximum landing energy, maintaining the deceleration rate consistent with the values used to determine performance distance.
- (D) Taxi at least three miles (normal braking, at least three intermediate stops, and all engines operating).
- (E) Park in an area so as to minimize wind effects until it is assured that fuse plug temperatures have peaked and that no plugs have released.
- (ii) In lieu of simulating the maximum kinetic energy landing during an accelerate-stop test, an actual landing and quick turn-around may be performed; however, caution should be exercised in order to prevent jeopardizing the safety of the flightcrew and airplane if the wheel plugs release right after liftoff, requiring a landing to be made with some flat tires. The following elements should be included in the tests:

- (A) Set engine idle thrust at maximum value specified (if applicable).
- (B) Conduct a landing stop at maximum landing energy, maintaining the deceleration rate consistent with the values used to determine performance distance.
- (C) Taxi to the ramp (three miles minimum with normal braking, at least three intermediate stops, and all engines operating).
- (D) Stop at the ramp. Proceed immediately to taxi for takeoff.
- (E) Taxi for takeoff (three miles minimum with normal braking, at least three intermediate stops, and all engines operating).
- (F) Park in an area so as to minimize wind effects until it is assured that fuse plug temperatures have peaked and that no plugs have released.

(iii) Fuse plug protection of wheels and tires should be demonstrated to show that the fuse plugs will release when excessive energies are absorbed. Normally, this will occur during RTO performance tests.

Section 5. FLOATS AND HULLS

57. - 59. [RESERVED]

(4) SR-450A 1(b) and § 25.1303(c) require that turbine-powered airplanes be equipped with a speed warning device that will provide aural warning whenever the speed exceeds V_{MO} plus 6 knots or $M_{MO} + 0.01M$. The regulations specify that the upper limit of the production tolerances permitted for the warning device shall be a speed not greater than the prescribed warning speed.

b. Procedures. The applicant should substantiate, by appropriate ground and/or flight tests with possible production instrument error corrections, that the system operates within the boundaries established by the regulation. Understanding that other procedures may be acceptable, this could be accomplished in accordance with the following:

(1) If the maximum allowable airspeed varies as a function of altitude, and is indicated by means other than a maximum airspeed versus altitude presentation in the airspeed indicator, it should be substantiated that the chosen means of maximum allowable airspeed indication provides an accurate presentation of the relationship between V_{MO} and altitude. The indicated V_{MO} should not exceed the actual V_{MO} for any altitude by more than six knots. This is particularly important for airplanes that have a step function in V_{MO} at an altitude of 10,000 feet due to bird strike considerations below that altitude.

(2) During production flights, the speed warning device shall provide warning at a speed equal to or less than $V_{MO} + 6$ knots or $M_{MO} + 0.01M$, minus the sum of the values stipulated in (i) and (ii) below:

(i) The possible error of the airspeed indicator or Mach meter used as the reference.

(ii) Three knots or 0.005M, if the airspeed indicator or Mach meter used as the reference has a static or pilot pressure source different from the pressure sources of the warning devices.

(3) The speed warning device shall be shown to comply with the requirements of (i) and (ii) below:

(i) During ground test using calibrated reference instruments, the installed speed warning device shall provide warning at a speed equal to or less than $V_{MO} + 6$ knots or $M_{MO} + 0.01M$. The procedure for this test should be processed in accordance with § 21.127(b)(5) or § 21.143(a)(3).

(ii) For each type design, a test should be conducted to show satisfactory correlation between the operation of the warning device during flight and the data obtained during the ground tests.

172. POWERPLANT INSTRUMENTS - § 25.1305. [RESERVED]

173. MISCELLANEOUS EQUIPMENT - § 25.1307. [RESERVED]

174. EQUIPMENT, SYSTEMS, AND INSTALLATIONS - § 25.1309.

a. Explanation. The following procedures, outline and paraphrase the appropriate provisions of § 25.1309. Further definition and explanation, if required, may be found in Part 25 of the Federal Aviation Regulations and in Advisory Circular 25.1309-1A, "System Design and Analysis," dated June 21, 1988.

b. Procedures.

(1) Evaluate functioning of required installed equipment to verify that performance is as intended under any foreseeable operating and environmental conditions.

(2) Evaluate failure conditions, as appropriate, to determine their impact on the capability of the airplane or the ability of the crew to operate it.

(3) Review, as appropriate, any design analyses, proposals, studies, or tests that correlate probabilities of failure condition occurrence with the effects of those failure conditions, to determine that they are properly categorized for the appropriate criticality level.

Section 6. PERSONNEL AND CARGO ACCOMMODATIONS

- (iv) Verify that all controls, displays, and annunciators consistent with normal and abnormal crew procedures, are satisfactorily identified, accessible, operable, and visible.
- (v) Electro-Magnetic Compatibility (EMC). Verify by observation that no adverse effects are present in the required flight systems.
- (vi) Following the flight, test the CVR audio recording in an appropriate laboratory, and evaluate for clarity of the recorded messages. Preferably the evaluators should not have advance information concerning the flightcrew conversations.
- (vii) Verify that the hot mike feature at each position allows for recording regardless of the position of the interphone transmit key switch (§ 25.1457(c)(5)).

(2) Digital Flight Data Recorder (DFDR).

- (i) Demonstrate operation of the DFDR self-test feature and, prior to collection of test data, set the trip number and date on the code switches of the Trip and Data Encoder, if so equipped.
- (ii) The certification data will be derived automatically during any appropriate flight that encompasses operation throughout the full flight envelope. Hand recorded data of heading (magnetic or true), barometric altitude, pitch attitude, indicated airspeed, and time (UTC) should be collected at several stabilized flight conditions for subsequent data correlation purposes.
- (iii) Following the flight, the data should be retrieved for correlation and accuracy verification.
- (iv) Demonstrate performance of intended function of the DFDR for all parameters specified in the operating rules (refer to Appendix B of part 121 for the relevant data ranges, accuracies, and recording intervals). Accuracy will be verified at stabilized points by correlating against, and comparing with, an approved instrumentation system or manual notes.
- (v) Electro-Magnetic Compatibility (EMC). Verify by observation that no adverse effects are present in the required flight systems.

g. Engine Interfacing Systems. [RESERVED]

h. Stability Augmentation Systems. [RESERVED]

i. All Weather Operation (Reduced Visibility) Systems. [RESERVED]

171. FLIGHT AND NAVIGATION INSTRUMENTS - § 25.1303

a. Explanation.

- (1) Section 25.1303(b)(1) requires an airspeed indicator to be visible at each pilot station. Additionally, if airspeed limitations vary with altitude, airspeed indicators must have a maximum allowable airspeed indicator showing the variation of V_{MO} with altitude. In practice, this maximum allowable airspeed indicator requirement is rarely complied with in a literal sense. The variation in V_{MO} is not normally depicted literally as a function of altitude, but rather as a radial marker on the airspeed indicator whose position varies as a function of altitude. This presentation of the maximum allowable airspeed limit, as a function of altitude, is approved based on a substantiation of equivalent safety with the literal interpretation of the rule.
- (2) Production tolerances for speed warning devices at V_{MO}/M_{MO} are required in accordance with § 25.1303(c) and SR450A.
- (3) Section 21.127(b)(2) requires each production flight test to include "An operational check of each part or system operated by the crew while in flight to establish that during flight, instrument readings are within normal range." Nowhere in these requirements is there any inference that the finite performance or quantitative limits, defined during type certification, need to be determined for each production airplane.

60. - 61. [RESERVED]

62. PILOT COMPARTMENT VIEW - § 25.773.

a. Explanation. (Reserved.)

b. Procedures. For detailed guidance on complying with pilot compartment view requirements, refer to Advisory Circular 25.773-1, "Pilot Compartment View for Transport Category Airplanes," dated January 8, 1993.

63. - 72. [RESERVED]

Section 7. EMERGENCY PROVISIONS

73. [RESERVED]

74. EMERGENCY EVACUATION - § 25.810(c).

a. Explanation.

(1) Installation of slip-resistant escape route. (See § 25.810(c) formerly § 25.803(e) See Advisory Circular 25-17, "Transport Airplane Cabin Interiors Crashworthiness Handbook," § 25.803(e), for guidance regarding slip resistant material.

(2) The effect of the slip-resistant surfaces on airplane performance, flight characteristics, and buffet should be evaluated and should, if necessary, account for significant drag increments.

b. Procedures. None.

75 - 83. [RESERVED]

(vi) Verify that there is no unacceptable mutual interference between the TOW system and other airplane systems and equipment.

(17) Instrument Comparator System.

(i) If an instrument comparator system is installed and activated, ensure the system monitors validity of and compares (side 1 vs. side 2) pitch and roll attitude, heading, radio altitude, localizer, and glideslope deviation information used for display in the cockpit instruments.

(ii) When these parameters exceed a preset threshold or trip level, or if an invalid condition is detected in any of the displayed information, an appropriate annunciator to that parameter will be illuminated.

(iii) A ground test on the airplane should be conducted to demonstrate performance of intended functions and validate the detector threshold levels. If annunciation is suppressed under certain conditions, these conditions should also be checked.

(iv) A flight evaluation should also be conducted to determine adequacy of the annunciator light locations and visibility under various lighting conditions and that the annunciators are properly identified.

(v) During flight, verify that the system is free from nuisance warnings and is compatible with other electronic systems.

(18) Reactive Windshear Warning System. A complete and comprehensive demonstration program (simulator and flight test) is contained in Advisory Circular 25-12, "Airworthiness Criteria for the Approval of Airborne windshear Warning Systems In Transport Category Airplanes," dated November 2, 1987.

(19) Traffic Alert and Collision Avoidance System. A complete and comprehensive demonstration program (laboratory/ground/flight test) is contained in Advisory Circular 20-131A, "Airworthiness And Operational Approval of TCAS II And Mode S Transponders," dated March 29, 1993.

f. Procedures-Recording Systems.

(1) Cockpit Voice Recorder (CVR).

(i) Demonstrate operation of the CVR self-test function and bulk erase feature.

(ii) During ground operations prior to and after engine start; during takeoff, climbout, cruise at V_{MO} / M_{MO} ; and during landing approach. Except where specifically noted, obtain the following CVR recordings:

(A) Flightcrew conversations using the area microphone.

(B) Flightcrew conversations using the oxygen mask microphones and the boom-microphone/handset, and the PTT hand-held microphones in flight and during ground operations.

(C) Radio transmissions by each crew member during cruise.

(D) Audio signals identifying navigation aids (through cockpit speakers and on radio channels) during landing approach.

(E) PA announcement during cruise.

(F) Selective (based on analysis) aural warning signals (see CAWS) during appropriate flight phases.

(iii) Use CVR circuit breaker to limit CVR recording to available capacity.

Section 8. VENTILATION AND HEATING

(14) Flight Warning Computer (FWC).

- (i) The FWC is a key subset of the overall warning, caution, and alerting system on the more modern airplanes. It is a microprocessor-based system that works in conjunction with, or totally replaces, the CAWS and MC/MW systems.
- (ii) The FWC incorporates sufficient computer capacity to perform many more functions than the MCS/MWS and, in addition to outputting to the visual warning displays and aural warning speakers, outputs hundreds of alerts/messages to other display media, most often an electronic display (Multi-function CRT on the instrument panel or the CDU portion of the Flight Management System).
- (iii) The added computer capacity also enables incorporating rather complex "inhibit" algorithms which, in turn, dictates a requirement for structuring a very complex ground test to verify operation of the inhibits. Review of the system description document will probably be required before any ground, flight, or bench tests can be defined.
- (iv) The flight evaluation should incorporate the tests described under CAWS and MC/MW systems.
- (v) Verify that the self-test feature functions properly.
- (vi) Simulate failure of selected sensor inputs to verify that the FWC detects the faults and illuminates the FWC fail annunciator.
- (vii) Demonstrate freedom from nuisance warnings by observing and logging nuisance events as they occur throughout the flight demonstration program. Assess the status at the end of the program by examining the log.

(15) Stall Warning Computer (SWC).

- (i) The SWC should be evaluated in conjunction with the stall tests described in Chapter 2, Section 6 of this Advisory Circular. Adequacy of the various warnings (stick shaker, warning light, aural (and voice) warning) should be assessed, in addition to the speed schedules.
- (ii) Demonstrate freedom from nuisance warnings during the takeoff, landing, and maneuvering flight tests described in Chapter 2 of this Advisory Circular. Further testing may be required to show freedom from nuisance warnings by the test requirements in Chapter 8 of this AC if special airworthiness approvals are sought.

(16) Takeoff Warning System (TOW).

- (i) The TOW system is usually a subset of the CAWS or MCS/MWS or FWC and is generally inhibited at nose wheel liftoff during the takeoff maneuver. It is usually armed when the squat switch indicates that the airplane is on the ground and one or more power levers are advanced beyond a prescribed position or engine thrust setting. The system alarms if the flaps/slats/stabilizer/spoiler/brakes are not set correctly for takeoff.
- (ii) Determine that each event is annunciated properly by conducting a static ground test.
- (iii) Flight evaluation during takeoff roll should be a qualitative assessment of the clarity, tone, and volume of each warning. Some systems incorporate a TEST switch, which facilitates activation during takeoff. If this feature is not available, it may suffice to check the audio level of a warning during touch and go landings (e.g., the "stabilizer" warning while accelerating to Vr speed).
- (iv) Simulate failure of selected sensor inputs to verify that the TOW system detects the faults and illuminates the fail annunciator (if installed).
- (v) Verify that the system "arm status" is not affected by electrical power transients, which occur when switching from ground or APU power, during engine start, following bus priority checks, etc.

84. VENTILATION - § 25.831.

a. Explanation.

- (1) This requirement deals with minimum ventilation requirements for each occupant of the airplane, control of the ventilating air, accumulation and evacuation of smoke and harmful or hazardous concentrations of gases or vapors, and failure conditions of the ventilation system. Specific quantities of fresh air along with carbon monoxide and carbon dioxide concentration limits are specified in the rule. Reference should be made to the paragraphs in this AC dealing with Cargo and Baggage Compartments, § 25.855; Exhaust Systems, § 25.1121; and Fire Extinguishing Agents, § 25.1197. AC 25-20, "Pressurization, Ventilation, and Oxygen Systems Assessment for Subsonic Flight Including High Altitude Operations," also provides guidance for ventilation requirements.
- (2) The objective of the inflight smoke evacuation test is to confirm that the flightcrew emergency procedures and the ventilation system are capable of handling heavy smoke, and to show that when using the emergency procedures, the smoke will dissipate at a reasonable rate. This is a quantitative and qualitative evaluation.

b. Procedures.

- (1) Flight testing should be conducted to ensure the amount of ventilation air provided meets the requirements specified and the flightcrew is able to accomplish their duties without undue fatigue and discomfort. Ventilation system controls in the flight deck should be demonstrated to perform their intended function.
- (2) The passenger and crew compartment should be monitored for the presence of carbon monoxide. Various flight and equipment configurations should be tested. A carbon monoxide test kit is normally used for this evaluation.
- (3) Inflight smoke evacuation testing should be conducted in accordance with Advisory Circular 25-9A, "Smoke Detection, Penetration, and Evacuation Tests and Related Flight Manual Emergency Procedures," dated January 6, 1994.

85. - 86. [RESERVED]

Section 9. PRESSURIZATION

87. PRESSURIZED CABINS - § 25.841.

a. Explanation

(1) Section 25.841(a) specifies cabin pressure altitude limits, as a function of the external pressure altitude, for cabins and compartments intended to be occupied. AC 25-20, "Pressurization, Ventilation, and Oxygen Systems Assessment for Subsonic Flight Including High Altitude Operation," dated 9/10/96, provides additional guidance for pressurized cabins. These cabin pressure altitude limits, to be demonstrated by flight testing, are:

- (i) Not more than 8,000 ft., at the maximum operating altitude of the airplane, for normal operation of the pressurization system.
 - (ii) For airplanes to be operated above 25,000 ft., the airplane must be able to maintain a cabin pressure altitude of not more than 15,000 ft. in the event of any reasonably probable failure or malfunction in the pressurization system.
 - (2) Though not addressed by § 25.841, airplanes may incorporate a "high altitude mode" to permit takeoff and landing at airports above 8,000 ft. For takeoff and landing altitudes above 8,000 ft., the cabin pressure limits to be demonstrated by flight testing are:
 - (i) Prior to beginning a descent into a high altitude airport, not more than 8,000 ft.
 - (ii) During a descent into or climb out of a high altitude airport, not more than 15,000 ft.
 - (iii) After a takeoff from a high altitude airport and after the cabin pressure altitude decreases to 8,000 ft., not more than 8,000 ft.
 - (3) Section 25.841(b)(6) requires an aural or visual warning to the flightcrew when the cabin pressure altitude exceeds 10,000 ft. For airplanes incorporating a high altitude mode that resets the cabin pressure altitude warning threshold, the reset warning activation level should not exceed 15,000 ft.
 - b. Procedures. It is recommended that the test airplane have the maximum allowable leakage rate permitted by the type design specifications. If an airplane does not meet this criteria, it will be necessary to substantiate compliance by additional testing or analysis for the maximum leakage rate allowed by the type design.
 - (1) Normal Operating Conditions - 8,000 Ft. Cabin Pressure Altitude.
 - (i) With the pressurization system operating in its normal mode, the airplane should be stabilized in the cruise configuration at the maximum operating altitude it is to be certificated for.

(ii) Initial approval of new individual Technical Standard Order approved (TSO'd) sensors, which have an equivalent function and interface as previously approved sensors, and are interfaced with a previously approved computer, may be approved by ground test. Applicable sensors (systems) are the air data computer system (ADC), the radio altimeter system (RA), and the Instrument Landing System (ILS).

(iii) Subsequent installations of identical computers and interfacing sensors in other airplane types will require a ground test and an uninstrumented functional flight test to determine proper functioning, freedom from interference, adequate sound and light levels, inhibit switch details, etc.

(iv) The functional flight test must include construction of a profile to selectively actuate each mode that the applicant elects to certify (not all modes are required by the FAA). Refer to the equipment supplier's system description to aid in constructing the flight profile.

(v) Evaluate the GPWS warning light and other annunciators for visibility in day and night lighting conditions.

(vi) Evaluate the sound level of the aural GPWS warning at V_{MO} with headsets on and with and without simultaneous radio communications.

(vii) Verify that the self-test function and the flap override switch perform their intended functions. The gear override switch should be verified as well.

(viii) Simulate failures of the ADC, RA's and ILS systems (open circuit breakers) and verify that the GPWS detects the faults and illuminates the GPWS fail annunciator.

(ix) Verify that conducting a radio altimeter self-test in flight will not induce a false GPWS failure warning.

(x) Verify that the GPWS does not adversely interfere or interact with other airplane systems.

(xi) Verify that the GPWS is free of inadvertent activation during electrical bus or generator switching.

(xii) Verify that the caution & warning priorities are assessed and that they include systems such as windshear. Example, windshear has priority over TCAS.

(12) Enhanced Ground Proximity Warning System (EGPWS), (RESERVED)

(13) Master Caution/Master Warning System (MCS/MWS).

(i) This system provides inputs to master warning (MW) and master caution (MC) lights located on the glare shield in front of each pilot and to the CAWS (see paragraph 170 e(8)). It contains the sensors, switches and logic required to assess the requirement for the warning and caution annunciators.

(ii) The system may contain logic to assess priority of the various warnings in order to sequence simultaneous actuation. If so, ground, flight, or bench tests may have to be conducted to verify this logic.

(iii) Some cautions may be inhibited during various phases of flight, particularly during the final stages of a Category III automatic landing operation (below alert height). If so, ground or flight tests may have to be structured to verify the inhibit logic. Also, certain warnings may be inhibited during the high speed stages of a takeoff roll. If this feature is incorporated, it too should be carefully substantiated.

(iv) Simulate failure of selected sensor inputs to verify that the MCS/MWS computer detects the faults and illuminates the fail annunciator (if installed).

(v) Verify that there is no unacceptable mutual interference between the MCS/MWS and other systems and equipment.

(8) Central Aural Warning System (CAWS).

(i) Most CAWS functions include aural (and voice, in some installations) warnings of the following typical airplane conditions:

Engine Fire	Altitude Advisory
APU Fire	Speedbrake
Overspeed	Autopilot Disconnect
Takeoff	Flap/Slat Overspeed
Stall	Cabin Altitude
Landing Gear	Stabilizer-In-Motion
Evacuation	

Pilot Call and SELCAL tones may also be included, although they are "Advisories" as opposed to "Warnings."

(ii) The logic for this system usually resides in another computer (e.g., the flight warning computer or master caution/master warning computer) in which case the two systems should be evaluated simultaneously. However, if the logic and/or computer governing activation of the warnings, priority logic, inhibits, etc. are contained in the CAWS itself, refer to the section covering the computers noted above for additional guidance on flight evaluation. Compliance may be shown by equivalent tests in a flight simulator or by bench tests.

(iii) Individual activation of each warning tone should be accomplished in flight under the most adverse noise conditions appropriate to the warning (e.g., V_{MO} / M_{MO} for overspeed, high speed descent for APU fire, acceleration following takeoff for flap/slat overspeed, etc.). Test switches and/or the self-test feature of the system would be an appropriate means to activate the warning.

(iv) The flight evaluation will be a pilot qualitative assessment of the clarity, tone, and volume of each warning.

(9) Overspeed Warning System. This system should be demonstrated in conjunction with the airspeed system calibration and should exhibit that it is consistently within the prescribed tolerances. The system tolerance is from V_{MO} to $V_{MO} + 6$ knots in the airspeed limited range, and from M_{MO} to $M_{MO} + 0.01M$ in the Mach limited range.

(10) Altitude Advisory (or Altitude Alerting) System.

(i) A ground test should be conducted to check the adequacy of the required pre-flight procedure provided in the Airplane Flight Manual.

(ii) A flight demonstration should be conducted at low, mid, and high altitudes to verify performance of the intended function of:

- (A) Alerting to an impending capture of a pre-selected altitude; and
 - (B) Alerting to an uncommanded departure from an assigned (selected) altitude.
- (iii) Low and high rates of vertical speed should be included in the evaluation with captures from above and below the pre-selected altitude.
- (iv) Determine adequacy of the alert light location and its visibility under various lighting conditions, and adequacy of the aural warning.

(v) A flight simulator may be used to perform appropriate tests.

(11) Ground Proximity Warning System (GPWS).

(i) Initial approvals of new GPWS should include flight evaluation with an instrumented airplane. The instrumented flight test of a computer type may be demonstrated on one airplane and the results made applicable to any other airplane with only a functional test being required.

(ii) The condition should be held long enough to record any cyclic fluctuations in cabin pressure due to relief valve operation.

(iii) The cabin pressure altitude should not exceed 8,000 ft.

(2) Failure Conditions - 15,000 Ft. Cabin Pressure Altitude.

(i) The critical reasonably probable system failure should be identified. The cabin pressure altitude warning system should be set to the high altitude side of its tolerance band or additional testing or analysis may be necessary for compliance. If more than one system failure mode is determined to meet the "reasonably probable" criteria, the flight test should be conducted for each failure mode identified.

(ii) The airplane should be stabilized in the cruise configuration at the maximum operating altitude it is to be certificated to, with the pressurization system operating in its normal mode.

(iii) After initiating the critical failure to allow the cabin pressure altitude to increase, the flight test crew should immediately don their oxygen masks, but take no further corrective action until 17 seconds after the 10,000 ft. cabin pressure altitude warning activates. Emergency descent procedures should then be initiated and the descent continued to an altitude below 15,000 ft.

(iv) The cabin pressure altitude should not exceed 15,000 ft. at any time during the test.

(3) High Altitude Takeoff Conditions (Greater than 8,000 Ft.).

(i) The pressurization system should be placed in its high altitude mode. It may be necessary to configure the oxygen system to prevent deployment of the oxygen masks at 10,000 ft., if the system is so designed. Airplane Flight Manual (AFM) procedures may need to be developed. The same applies to high altitude landings above 10,000 ft.

(ii) The cabin pressure altitude should not exceed 15,000 ft. during an actual climb-out from a high altitude airport to the maximum operating altitude the airplane is to be certificated for, or during an inflight simulation of such a climb-out. The simulation should commence the climb, from a starting altitude of 8,000 ft. or more, with the airplane unpressurized.

(iii) The cabin pressure altitude should eventually decrease to 8,000 ft. and then not exceed 8,000 ft. for the duration of the test.

(4) High Altitude Landing Conditions (Greater than 8,000 Ft.).

(i) The airplane should be stabilized in the cruise configuration prior to beginning a descent.

(ii) The pressurization system should be placed in its high altitude mode.

(iii) The cabin pressure altitude should not exceed 15,000 ft. during the descent to an actual, or simulated, landing at a high altitude airport.

88. TESTS FOR PRESSURIZED CABINS - § 25.843.

a. Explanation

(1) Section 25.843(b)(3) requires flight testing to evaluate the performance of the pressurization system and all related sub-systems at maximum altitude and under the dynamic conditions of climbing and descending flight. This testing substantiates the ability of the pressurization system to function correctly in stable and dynamic external pressure conditions.

(2) Section 25.843(d)(4) requires an investigation of the functionality of all doors and emergency exits after the flight test required by § 25.843(b)(3). The concern is the potential for jamming caused by the variable relative positions of doors and fuselage structure during the pressurization/depresurization cycle.

b. Procedures. The following tests may be initiated from an airport at any altitude within the airplane's proposed takeoff limitations. The pressurization system should be operated in its normal mode. The Master Minimum Equipment List (MMEL) dispatch may be taken into consideration and additional testing required to verify MMEL configuration.

(1) Steady Climb/Descent. The steady climb/descent pressurization system tests should be performed under conditions (i.e., weight, altitude, temperature, and configuration) that will result in rates of climb/descent corresponding to the maximum attainable within the operating limitations of the airplane.

(i) After takeoff, maintain a stable, continuous climb to the maximum operating altitude the airplane will be certificated to.

(ii) Maintain that altitude until the cabin pressure altitude has stabilized.

(iii) Initiate a steady, maximum rate of descent within the operating limitations of the airplane down to the airport.

(2) Stepped Climb/Descent. The stepped climb/descent pressurization system tests should be performed under conditions (i.e., weight, altitude, temperature, and configuration) that will result in rates of climb/descent corresponding to the maximum attainable within the operating limitations of the airplane.

(i) After takeoff, initiate a stepped climb to the maximum operating altitude the airplane will be certificated to. Step increments should be 5,000 to 7,500 ft.

(ii) Maintain each level-off altitude long enough for the cabin pressure altitude to stabilize.

(A) Display altitude without loss of signal indications or excessive fluctuations, under the following conditions:

(1) Pitch angle ± 5 degrees about the mean approach altitude.

(2) Roll angle zero to ± 20 degrees.

(3) Forward velocity from minimum approach speed up to 200 knots, in appropriate configurations.

(4) At altitudes from 0 to 200 feet with sink rates of 0 to 15 feet/second, in landing, approach, and go-around configurations.

(B) Track the actual altitude of the airplane over level ground without significant lag or oscillation.

(iii) With the airplane at an altitude of 200 feet or less, verify that any abrupt change in terrain, representing no more than 10 percent of the airplane's altitude, does not cause the altimeter to unlock. The indicator response to such changes should be appropriate. If the system unlocks, it should re-acquire the signal promptly without pilot intervention.

(iv) Caution should be exercised on airplanes equipped with Automatic Landing Systems if the radio altimeter system is prone to unlock while flying final approach over irregular terrain, since in all probability, the unlock will adversely affect the Autoland Availability requirement.

(v) If a Decision Height (DH) function is provided, verify proper operation at minimum altitudes of 200 feet, 100 feet, and 50 feet.

(vi) Verify that the push-to-test self-test feature generates a simulated radio altitude of less than 500 feet, and that no other systems experience unintended effects or interference. For aircraft with automatic landing systems, the Self-Test feature should be shown to be inhibited during the low altitude phases of the autoland.

(vii) Verify that the system provides a positive failure warning display any time there is a loss of power or a failure of the altimeter to function properly.

(viii) Verify that the radio altimeter system neither contributes to, nor is affected by, Radio Frequency or Electromagnetic Interference.

(6) On-Board Weight and Balance System

(i) In conjunction with conducting the airplane flight test program, on a pre-flight and post-flight basis, continually check and record the gross weight and center of gravity indications of the system with independently and accurately derived values of gross weight and CG.

(ii) Electromagnetic Compatibility (EMC). Verify that this system does not create adverse effects on any other required flight systems.

(7) Emergency Locator Transmitters (ELT). Flight testing of the ELT function is not allowed; however, evaluation of the effects of inadvertent actuation of ELT on other flight systems should be made. One method is to transmit on the VHF Communication System, whose antenna is closest to the ELT antenna, for a period of 3 seconds on frequencies spaced 0.5 MHz apart throughout the VHF communication band. Verify that the ELT is not activated by any transmission, no adverse interference is generated on VOR systems due to ELT/COM/VOR interactions, and that the desired VHF communication is established.

(K) Verify that all controls, displays, and annunciators are satisfactorily identified, accessible, operable, and adequate for direct sunlight and night conditions.

NOTE: It is possible that some of the above items can be accomplished in a laboratory or simulator environment.
(viii) Verify that there is no unacceptable mutual interference between the attitude system and other systems and equipment.

(3) Angle of Attack (AOA) System.

- (i) Pilot interface with this system will generally be a consequence of presenting a raw data readout in the cockpit and/or driving the Slow/Fast (S/F) display on the ADI, (if so equipped)
- (ii) Evaluate the displays during normal approaches and landings to assure reasonable/proper information is being presented for the particular flap setting and VREF speed over the gross weight and center of gravity range of the airplane (S/F should be centered).
- (iii) Conduct left and right sideslips that would be representative of normal operation on approach during crosswind landings or engine-out conditions.
- (iv) Determine that the malfunction indicators (flags) are appropriately displayed and are satisfactory annunciators.
- (v) Qualitatively assess that the thresholds of displays are wide enough to permit the pilot to follow the indicators, as appropriate to the operation of the airplane.
- (vi) Determine that instrument presentation is sufficiently damped to permit use in turbulent air and that hysteresis, if present, is acceptable.
- (vii) Verify that the AOA system neither contributes to, nor is affected by, Radio Frequency/Electromagnetic Interference (RFI/EMI).

(4) Air Data System.

- (i) The air data system performance, with the exception of airspeed calibration, will generally be demonstrated qualitatively by observation of the output displays.
 - (ii) Be particularly observant of barometric altimeter and vertical speed reversals as a function of rapid pitch attitude changes (e.g., takeoff rotation).
 - (iii) Verify that the Mach/Airspeed indicators operate smoothly throughout the complete speed envelope of the airplane.
 - (iv) Observe correct operation of the overspeed warning indicator (barber pole) while approaching V_{MO}/M_{MO} speeds.
 - (v) Observe the static and total air temperature (SAT/TAT) indicators for reasonableness of data presentation.
 - (vi) Verify that the air data system neither contributes to, nor is affected by, Radio Frequency/Electromagnetic Interference.
- (5) Radio Altimeter System.
- (i) The radio altimeter system should display to the flightcrew, clearly and positively, the altitude information that indicates the airplane main landing gear wheel height above terrain.
 - (ii) Under the measurement conditions described, verify that the altimeters:

(iii) Initiate a stepped descent from the maximum altitude allowing the cabin pressure altitude to stabilize at each level-off altitude. Step increments should be 7,500 to 10,000 ft.

(3) Positive Pressure Relief. If two valves are provided, one should be deactivated for this test.

- (i) After takeoff, climb to the operating altitude that provides maximum cabin differential pressure.
 - (ii) Manually close the outflow valve, allowing the cabin differential pressure to increase.
 - (iii) Verify the cabin pressure differential pressure warning functions properly.
 - (iv) Verify that the relief valve functions and the maximum cabin differential pressure is not exceeded.
- (4) Negative Pressure Relief/Emergency Descent. If two valves are provided, deactivate one for this test.
- (i) At cruise altitude, perform an emergency descent with the airplane in the critical condition for negative pressure on the fuselage.
 - (ii) Verify that the maximum negative differential pressure for the fuselage is not exceeded.

(5) Manual Cabin Pressure Control. If manual means for pressure control are provided, these means should be evaluated under normal and emergency operations of the airplane and flight envelope.

(6) Testing of Doors and Exits.

- (i) Prior to flight, all doors and exits should be checked for proper operation.
- (ii) After returning from a flight where the airplane is subjected to the maximum certificated altitude and cabin pressure differential pressure, and immediately upon landing, all passenger doors and emergency exits should be opened. There should be no change in the operating characteristics of any door or emergency exit relative to its pre-flight operation.

Section 10. FIRE PROTECTION (RESERVED)

on the first officer's side), compatibility of the two systems should be demonstrated (i.e., no excessive attitude monitor trips, no adverse influence on system availability (such as autoland) due to monitor trips, etc.). This also holds true for either mode of AHRS operation (NORMAL/BASIC or STANDBY), if this feature is available in the system.

(V) For systems that have two operational modes (NORMAL and BASIC), annunciation of the fact that the system is operating in the reversionary (BASIC) mode is largely dependent on the "user" system's architecture. For example, if the airplane is equipped with a CAT III autoland system or CAT III Head-up display (HUD) system, the performance in these modes with Basic Attitude may be degraded to the point where airplane safety is compromised in CAT III weather conditions. There must then be clear and unmistakable annunciation of the fact that this attitude condition exists.

(VI) For triple AHRS installations, switching is provided to substitute the third AHRS for either the captain's or first officer's system. Annunciation of the fact that the switched condition is in existence may or may not be required, depending on cockpit layout, pilot workload considerations, etc. This is an assessment generally made by the FAA project pilot. The same holds true for annunciation of whether or not the third system is inoperative.

(vii) Some additional flight evaluation suggestions follow:

(A) While on the ground, determine that the attitude system provides usable attitude information through 360 degrees of roll and pitch by rotating the platform through 360 degrees of roll and pitch while observing the appropriate attitude indicator.

(B) Verify the system performs as intended, providing satisfactory attitude and heading information to the pilot's and copilot's attitude and heading instruments throughout the normal airplane flight envelope, including unusual attitudes that may be expected in service.

(C) Verify that the flight control system functions properly when interfaced with the attitude system. This functional evaluation may be accomplished during a typical flight profile encompassing enroute, maneuvering, and coupled approach operations.

(D) Determine that loss of the air data system or airspeed input is properly annunciated and that the systems continue to provide satisfactory attitude/heading information.

(E) Verify that the comparator monitor provides proper annunciation of attitude/heading disparity.

(F) Verify that loss of a single power source does not cause loss of both attitude systems simultaneously.

(G) Verify that attitude/heading data from each is not lost for more than 1 second following loss of a primary power source (generator, alternator, inverter, etc.) simultaneous with loss of the associated powerplant.

(H) Verify that the system can be realigned in flight after being shutdown for more than 3 minutes (if applicable).

(I) Verify that each attitude system continues to operate correctly following a simulated airplane electrical power loss of "X" seconds (equipment specific), by removing power from each respective electrical bus.

(J) Verify proper operation of the back-up battery (if installed) and display of appropriate flags by pulling the attitude circuit breaker. Note that the system operates correctly on back-up battery power for approximately "X" minutes (equipment specific) and then shuts down. Determine that the appropriate flags appear on the effected displays.

standby compass system. These readings should be compared with the flight recorder data as a check on compass repeater capability.

(iv) Observe indicators for evidence of electronic or magnetic interference. Specifically, observe the standby compass operation as a function of windshield heat cycling and while keying radio transmissions.

(2) Attitude System--"Strapdown" (AHRS & IRS).

(i) In addition to flight evaluation of the pitch and roll attitude characteristics of conventional vertical gyros, which is rather straight-forward, the microprocessor-based strapdown attitude (and heading) systems present some additional considerations for certification and flight testing, which are discussed herein. Attitude and Heading Reference Systems (AHRS) and Inertial Reference Systems (IRS) are the types of systems envisioned.

(ii) Validation of acceptable equipment installations includes, but is not limited to, the validation of proper installation considering the combined effects of temperature, altitude, EMI, vibration, and other various environmental influences. These installation requirements are applicable to critical, essential, and non-essential systems. However, there may be cases where non-essential installations do not warrant the expense of having all, or even part, of these tests and analyses conducted. The necessity for conducting these on non-essential installations should, therefore, be determined on a case-by-case basis by the FAA project engineer, based on the specific and individual circumstances involved. Particular attention should be paid to the following environmental considerations:

(A) Vibration. Testing is generally accomplished on the sensor level to DO-160C requirements. The structural mounting provisions on the airplane should provide assurance that the DO-160C levels are not exceeded when the airplane encounters gusts, as defined in Appendix G to Part 25. The concern is that the dynamic range of the sensor may be exceeded during this vibration encounter.

(B) Temperature. Some systems have temperature monitors built into the sensor block. When the device temperature reaches a given level, the system automatically "shuts-down." This condition could represent a common mode failure wherein insufficient cooling is provided to the multiple sensors, with the consequent result that they all "trip" the temperature monitor simultaneously. Some equipment may be constructed with the cooling mechanism integral to the individual unit. Regardless of how the equipment cooling is accomplished, if the proper operation of the unit is below acceptable levels due to failures of the cooling function, then the cooling function must be addressed by analysis and demonstration, where applicable.

(C) Power Bus Transients. After the normally expected electrical bus transients due to engine failure, attitude should not be off or unstable for more than one second and should affect only displays on one side of the airplane. If power-up initialization or self-tests are started by the transient, any change in attitude should not be distracting; recognizably valid pitch and roll data should be available within one second. For most airplanes, an engine failure after takeoff will simultaneously create a roll rate acceleration, new pitch attitude requirements, and an electrical transient. Attitude information is paramount; transfer to standby attitude or transfer of control of the airplane to the opposite pilot cannot be reliably accomplished under these conditions in a timely enough fashion to prevent an unsafe condition. In testing this failure mode, switching the generator off at the control panel will usually result in the quickest switching time. Conversely, during an engine failure, as the engine speed decays, the generator output voltage and frequency each decay to a point where the bus control relays finally recognize the failure. This can be a significantly larger disturbance resulting in a different effect on the using equipment. One way to simulate this failure is with a fuel cut, at a safe altitude and airspeed. Both means should be tested.

(iii) Multi-axis Failures - Failure Modes and Effects Analyses (FMEAs) generally do not rule out the combined pitch/roll attitude failures. If this failure condition can propagate through the autopilot, a need may exist for demonstrating multi-axis autopilot hardovers, as described in paragraph 181 of this AC. If the autopilot system architecture is such that the failure cannot get through to the control surface (i.e., input sensor screening, fail-passive autopilot, reasonableness tests, etc.), the need for hardover demonstration may be eliminated. Be aware of the fact that most fail-passive cruise mode autopilots may not be truly fail-passive when reconfigured to reversionary modes.

(iv) Attitude Sensor Intermix - If the applicant is seeking certification credit for sensor intermix (e.g., vertical and directional gyros (VG/DG) on the captain's side, and attitude/heading reference system (AHRS)

CHAPTER 5 - POWERPLANT

Section 1. GENERAL

89. INSTALLATION - § 25.901. [RESERVED]
90. ENGINES - § 25.903
- a. Engine Isolation - § 25.903(d).
- (1) Explanation. Approval of Engine Isolation Criteria - The powerplants, and all systems controlling or influencing the performance of the powerplants, must be arranged and isolated from each other to allow operation, in at least one configuration, so that a failure of any engine or any said system will not:
- (i) Prevent the continued safe operation of the remaining engines; or
- (ii) Require immediate action by any crewmember for continued safe operation.
- (2) Procedures.
- (i) Automated control functions incorporated to reduce crew workload, which impact the engine operation and control, may require flight tests to demonstrate the effects of various simulated failures, including engine surging and single engine failures. Failures in systems such as the auto-throttles, digital flight guidance computers, engine synchronizers, and electronic engine controls may need to be simulated to ensure that surging or a failure in one engine system will not hazardously affect control and operation of the remaining engine systems. Such failure simulations may include disruption of electrical power to selected control components, as well as simulated engine failures (throttle chops).
- (ii) The applicant should submit a comprehensive test plan detailing the test conditions and failure modes to be simulated. Careful consideration should be given to conducting these tests at safe altitudes and airspeeds, since results of the failure simulations may not be entirely predictable. Where possible, without compromising test results, on-aircraft (i.e., installed engines) tests of this type should be accomplished on the ground.
- b. Control of Engine Rotation - § 25.903(c).
- (1) Explanation. Section 25.903(c) requires that a means be provided to stop the rotation of any individual engine in flight. An exclusion is provided for turbine engines whereby a means to stop rotation need only be provided in cases where continued rotation could jeopardize the safety of the airplane. If means are not provided to completely stop the rotation of turbine engines, it should be shown that continued rotation, either windmilling or controlled, of a shut down turbine engine will not cause:
- (i) Powerplant (including engine and accessories) structural damage that will adversely affect other engines or the airplane structure;
- (ii) Flammable fluids to be pumped into a fire or into an ignition source; or
- (iii) A vibration mode that will adversely affect the aerodynamic or structural integrity of the airplane.
- (2) Procedures. None.
- c. Turbine Engine Installations - § 25.903(d).
- (1) Explanation. Section 25.903(d) presents specific concerns related to turbine engine installations. The requirements presented in § 25.903(d)(2) are intended to ensure that the installed powerplant control devices, systems, and instrumentation will reasonably protect against exceeding engine operating limitations that adversely affect turbine rotor integrity.
- (17) Flight Management System (EMS). A complete and comprehensive flight test evaluation is contained in Advisory Circular 25-15, "Approval of Flight Management Systems In Transport Category Airplanes," dated November 20, 1989.
- (18) Global Positioning System (GPS). A complete and comprehensive flight test evaluation is contained in Advisory Circular 20-138, "Airworthiness Approval Of Global Positioning Systems (GPS) Navigation Equipment For Use As A VFR And IFR Supplemental Navigation System," dated May 25, 1994.
- (19) Microwave Landing System (MLS). [RESERVED]
- d. Procedures-Instruments and Displays.
- (1) Flight and Navigation Instruments.
- (i) Flight demonstration of the following pilots' instruments should address evaluation with regard to display, function, and lighting:
- (A) Attitude Director Indicator (ADI)-primary and standby
- (B) Horizontal Situation Indicator (HSI)
- (C) Radio Magnetic Indicator (RMI)
- (D) Airspeed and Mach No. Indicator-primary and standby (if installed)
- (E) Altimeter-primary and standby
- (F) Instantaneous Vertical Speed Indicator (IVSI)
- (G) Standby Compass
- (H) Clock
- (I) Total Air Temperature Indicator (TAT)
- (J) Radio Altimeter Indicator (RA)
- (ii) The instruments should be evaluated for suitability of location and performance during flight operation. Agreement between displayed functions, primary to standby, and captain's to first officer's display (where applicable) should be examined during takeoff, cruise, and landing, and during flight maneuvers of bank angles of ± 60 degrees and pitch angles from +25 to -10 degrees.
- (iii) In addition to the above instruments, the controls on the instrument, and those associated with changing the function of that instrument, should be evaluated.
- (iv) Day and night lighting of instruments must be demonstrated. Evaluate for adequate illumination of the instruments and associated control panels and placards.
- (2) Electronic Display Systems. A complete and comprehensive description and flight evaluation is contained in Advisory Circular 25-11 "Transport Category Airplane Electronic Display Systems," dated July 16, 1987.
- e. Procedures-Sensors and Warning Systems.
- (1) Compass System.
- (i) Conduct a ground compass swing and record deviations from correct magnetic headings at 15 degree intervals. Be particularly attentive for errors induced by intermittently operated electrical equipment that is not removable by compass compensation plates. (See chapter 16, section 5, of AC 43.13-1A, "Acceptable Methods, Techniques and Practices," dated 1988, or latest revision.)
- (ii) Compare indicated heading information with known runway directions during takeoffs and landings.
- (iii) Conduct an in-flight compass check by stabilizing the airplane on the four cardinal headings and recording the respective compass headings of both primary compass systems (in the slaved mode) and the

- (2) Intermixing of Engines. Engines with different ratings, and/or with different cowls, may be intermixed on airplanes, provided the proper limitations and performance information associated with the engine combination are used. In general, for four-, three-, or two-engine airplanes, the performance combination is as follows:
- (i) When one lower thrust engine is installed, the normal Airplane Flight Manual (AFM) performance level is reduced by an increment appropriate to the decrease in thrust resulting from the intermix.
 - (ii) When more than one lower thrust engine is installed, the AFM performance should be based on the thrust of the lower/lowest rated engine.
 - (iii) The minimum control speeds (V_{MCG} , V_{MCA} & V_{MCL}) must be based on the highest thrust engine(s).
 - (iv) The operating procedures must be provided for all engines installed (i.e., airstart altitude/airspeed envelopes, crew responses to engine warning systems, etc.). Differences in operating methods shall be limited to the equivalent of having a maximum of two different engines on the airplane.
 - (v) A maximum of two takeoff thrust settings (EPR or N_1) are permitted for airplanes with intermixed engines; this includes differences related to air conditioning pack and compressor bleed configurations.
 - (vi) A placard, identifying the location of the non-standard engine type, must be installed. All engine limits and instrument markings should be appropriate to the engine installed at each location. EPR, N_1 , N_2 , EGT, etc. limits for each engine, or the ratings at which they will be operated, must be properly presented to the pilot in accordance with §§ 25.1541 and 25.1543 and Part 121 of the FAR.
- d. Engine Restart Capability -- § 25.903 (e).
- (1) Explanation:
 - (i) Approval of Engine Restart Capability. An altitude and airspeed envelope must be established by the applicant for in-flight engine restarting, and means provided to restart each engine in flight within this envelope.
 - (ii) Engine Restart Envelope. For turbojet and early turbofan engines with low bypass ratios (approximately one), inflight restart capability was generally provided by "windmilling" of the engine. The windmilling airflow through these engines was capable of providing enough rotational energy to permit inflight restarting throughout most of the approved airspeed-altitude operating envelope. From the experience gained with these first-generation engines, acceptable restart capability has been established as 30 seconds from "FUEL ON" to ignition, and 90 seconds from "IGNITION" to stabilized idle. The 90 second ignition to idle time upper limit is based on the ability of the flightcrew to perceive the progression of the engine start by monitoring the time rate-of-change of N_2 and exhaust gas temperature. As bypass ratios increased, and rotational energy requirements increased, the "windmilling" restart envelopes became smaller. Some higher bypass ratio engines require an assist from an auxiliary pneumatic source, such as bleed air from an operating engine or an inflight operable Auxiliary Power Unit (APU), to provide restart capability over a large portion of the airplane operating envelope. Turbo-prop engines, particularly those with free-turbines, also require some sort of "auxiliary" start assist; this is generally provided by an electric starter or, in some cases, an inflight operable APU. Engine restart envelopes should clearly distinguish between the areas of different restart capabilities in terms of time to restart, windmilling only restart, and auxiliary air assisted restart. If an APU is required for restart over a significant portion of the operating envelope, a separate inflight start envelope should be substantiated by flight test for the APU in the "cold-soaked" condition associated with medium to high altitude cruise conditions. Engine and APU (if applicable) restart envelopes, and related procedures, should be included in the limitations section of the Airplane Flight Manual.
 - (iii) All-Engine Restart Capability. As technological advancements increased specific engine thrust output with a simultaneous decrease in specific fuel consumption, and wing designs produced greater lift, the number of engines required for a given airplane weight has decreased to the point where the majority of modern

- (v) Attitude (if provided to the basic instruments).
 - (A) The system must be installed to provide pitch and roll data to ± 1 degree relative to the airplane's reference level.
 - (B) During navigation tests, the vertical gyro data should be checked. Additionally after NAV tests are completed, the airplane should be flown and placed in a 25 degree bank with the INS in NAV mode. While in the turn, switch to ATT REF mode, and level the airplane. The attitude data should indicate properly. If the system requires level flight at the time ATT REF is selected, the AFM should contain the limitation.
 - (C) Power Bus Transients. After the normally expected electrical bus transients due to engine failure, attitude should not be off or unstable for more than one second and should affect only displays on one side of the airplane. If power-up initialization or self-tests are started by the transient, any change in attitude should not be a distraction; recognizably valid pitch and roll data should be available within one second. For most airplanes, an engine failure after takeoff will simultaneously create a roll rate acceleration, new pitch attitude requirements, and an electrical transient. Attitude information is paramount; transfer to standby attitude or transfer of control of the airplane to the opposite pilot cannot be reliably accomplished under these conditions in a timely enough fashion to prevent an unsafe condition. In testing this failure mode, switching the generator off at the control panel will usually result in the quickest switching time. Conversely, during an engine failure, as the engine speed decays, the generator output voltage and frequency each decay to a point where the bus control relays finally recognize the failure. This can be a significantly larger disturbance resulting in a different effect on the using equipment. The only known way to simulate this failure is with a fuel cut. Both means should be tested.
 - (vi) Electromagnetic Compatibility. The INS should not cause the performance of other systems aboard the airplane to be degraded below their normal function, and INS operation should not be adversely affected by other equipment.
- (10) Omega/VLF Navigation System. A complete and comprehensive flight test evaluation is contained in Advisory Circular 20-101C, "Airworthiness Approval of Omega/VLF Navigation Systems for use in the U.S. National Airspace System (NAS) and Alaska," dated September 12, 1988.
- (11) Loran-C Navigation System. A complete and comprehensive flight test evaluation is contained in Advisory Circular 20-121A, "Airworthiness Approval of Loran-C Navigation Systems for use in the U.S. National Airspace System (NAS) and Alaska," dated August 24, 1988.
- (12) Doppler Navigation System. Doppler Navigation System installed performance should be evaluated in accordance with Advisory Circular 121-13, "Self Contained Navigation Systems (Long Ranges)," dated October 14, 1969. (See also 14 CFR part 121, Appendix G, and paragraph 170c(9) of this AC, which addresses Inertial Navigation Systems.)
- (13) Area Navigation (RNAV). Information pertinent to flight evaluation of area navigation is contained in Advisory Circular 90-45A, "Approval of Area Navigation Systems for Use in the U.S. National Airspace System," dated February 21, 1975. Note that the area navigation function is most often performed by the systems identified in paragraphs 170c(9), (10), (11), (12), and (14) of this AC. Flight test requirements should be reviewed accordingly.
- (14) Multi-Sensor Navigation System. A complete and comprehensive flight test evaluation is contained in Advisory Circular 20-130A, "Airworthiness Approval of Navigation or Flight Management Systems Integrating Multiple Navigation Sensors," dated June 14, 1995.
- (15) Vertical Navigation System (VNAV). A complete and comprehensive flight test evaluation is contained in Advisory Circular 20-129 "Airworthiness Approval Of Vertical Navigation (VNAV) Systems for use in the U.S. National Airspace (NAS) and Alaska," dated September 12, 1988.
- (16) Performance Management System (PMS). A complete and comprehensive flight test evaluation is contained in Advisory Circular 25-15 "Approval of Flight Management Systems in Transport Category Airplanes," dated November 20, 1989.

transport category airplanes are equipped with just two engines. Service history has recorded a number of inflight all-engine thrust loss incidents from various causes: flameouts from inclement weather conditions, volcanic ash ingestion, fuel nozzle coking, fuel contamination and several cases of flightcrew fuel mismanagement. These incidents have occurred during takeoff climbout and in high altitude cruise. Consequently, it should be substantiated by flight test that restart capability exists following the inflight shutdown of all engines. This should be demonstrated for the momentary shutdown from a high power setting, associated with the takeoff and climb flight regimes, and the extended shutdown at medium to high altitude where the engines may be "windmilling" and/or "cold soaked."

(2) Procedures.

(i) Tests should be conducted to determine that inflight restarting can be accomplished within the envelope provided. Restarts at the conditions of the critical corners of the envelope and at or near the high altitude extremes of the envelope should be conducted to verify the boundary conditions of the envelope.

(ii) Inflight engine restart capability should also be evaluated with regard to suction feed climb conditions at the minimum suction feed reflight altitude, and loss of normal AC power (Ref: § 25.1351(d)).

(iii) The engine operating characteristics should be evaluated during each restart. In particular, any tendencies for the engine to surge, dwell for abnormally long periods below idle, or produce other unusual vibration or audible noises should be noted.

(iv) To address the dual engine flameout case during takeoff and initial climb-out, with the engines initially at maximum climb thrust (or higher), it should be demonstrated that the test engine will accelerate to the initial power setting after a brief shutdown (up to 15 seconds), when the fuel source is restored.

(v) To address dual engine flameout at high altitude (greater than 20,000 feet), it should be shown, by a combination of flight test and analysis, that the engines can be restarted, and the airplane's descent arrested, with a total altitude loss of not more than 5000 feet. Additionally, engine restart should be accomplished prior to exceeding 300 knots IAS.

(vi) If an onboard auxiliary power unit (APU) is required to provide power assist for inflight engine restart, the minimum APU start reliability should be determined, and its operation evaluated by flight tests in critical portions of the flight envelope.

(vii) If start cartridges are used to provide restart capability, they should be of sufficient capacity (or number) to provide at least two start attempts for each engine.

(viii) The inflight engine restart envelope presented in the Airplane Flight Manual (AFM) should identify a "core windmill reflight envelope" that will provide engine ignition within 30 seconds and stabilized idle within 90 seconds of restart initiation. A larger envelope, which includes appropriately labeled longer restart times, may be allowed if it can be shown that indication of a clear progression of engine start is provided to the flightcrew. The AFM should also contain the restart procedures appropriate to each phase of flight (i.e. low altitude "hot start," high altitude "cold soaked" start, etc.).

91. AUTOMATIC TAKEOFF THRUST CONTROL SYSTEMS (ATTCS) - § 25.904.

a. Explanation.

(1) Beginning in the 1970's, some manufacturers of turbojet powered airplanes elected to equip their airplanes with engine thrust control systems that automatically increased the thrust on the operating engine(s) when any engine failed. A similar system, referred to as an Automatic Takeoff Power Control System, was subsequently installed on turbopropeller airplanes.

(2) Takeoff performance credit was granted for ATTCS based upon prescribed system functional and reliability requirements, and performance related restrictions (e.g., initial takeoff thrust must not be less than 90 percent of that set by the ATTCS).

(2) When the conditions as described by the manufacturer are satisfied, set the mode selector to "Navigate". Verify that the NAV mode is achieved and no "warn" condition is indicated. Record the time at which NAV mode is verified.

(E) Departure Procedure.

(1) Taxi. While taxiing the airplane, monitor INS performance with the CDU data selector set to display track angle and ground speed.

(2) Takeoff. With the CDU set as required to observe ground speed, track angle, HDG, and drift angle during takeoff and initial airborne conditions, verify normal and proper performance. Reasonable assessment may be accomplished using other instruments and avionics..

(3) Initial track. Define a track from present position to first available waypoint and fly to intercept using instrument display or autopilot.

(F) In Flight. During flight conditions, perform and/or check the following: (NOTE: Do not change system mode selector from "Navigate" during navigational tests. If system is installed to provide attitude for the airplane system, the "ATT REF" mode must be checked after navigation mode tests are completed). When selector is changed to "ATT REF", ascertain that all appropriate equipment annunciators indicate the disconnect.)

(1) Exercise all procedures, such as waypoint navigation, officer navigation, selected track navigation, etc., that are listed as system capabilities by the manufacturer and in the Airplane Flight Manual (AFM).

(2) If updating capabilities are provided, either as manual or automatic, use defined procedures to verify operation.

(3) Operate the INS in both the manual and automatic modes for waypoint sequencing.

(4) Verify satisfactory control of the airplane, proper flight director indication, and flight instrument presentation, as appropriate to the installation. When the INS is operating, all airplane displays that would be affected or changed in meaning should be clearly annunciated to the pilot (e.g., compass heading (true versus magnetic) autopilot coupled modes, etc.).

(5) Operate the CDU in all display settings and verify functions and operation.

(6) Operate other avionics and airplane electrical systems to determine if any mutual interference results that would cause either the INS or other systems' performance to be less than required.

(Z) If basic accuracy has been previously established, a triangular course should be flown with a base leg length of at least one hour. The required accuracy is defined in paragraph 170(9)(f), above.

(G) Post Flight.

(1) Park the airplane at a position known to within 0.1 NM and determine the radial error rate using the total time in NAV mode and the measured radial error. Record end point position, time, and error rate calculations.

NOTE 1: On some models, radial error may be obtained as follows: Load the park position as waypoint N; then define track (LEG) O to N. The value of distance read on the CDU is the radial error.

NOTE 2: If the system has been updated, remove the update prior to error calculations.

(2) Pull INS primary power circuit breaker and verify operation on battery for 5 minutes. Reset breaker and verify that the system functions normally and the waypoint data is correct.

(3) Turn system to off.

(3) These systems represented "novel or unusual design features" not adequately addressed by the requirements of Part 25 at the time. Consequently, the airworthiness requirements for the early ATTCS certifications were prescribed in special conditions in accordance with § 21.16. The regulatory and technical content of those special conditions was added to Part 25 as § 25.904 and Appendix I by Amendment 25-62.

b. Procedures. Certification of an airplane with an ATTCS requires flight test demonstration of certain performance and functional aspects of the system, as outlined below:

(1) Takeoff speeds, as limited by V_{MCG} and V_{MCA} , must reflect the effect of ATTCS operation following failure of the critical engine. It is permissible to publish two sets of takeoff performance data: one for ATTCS unarmed and one for ATTCS armed. In such cases, the AFM limitations, operating procedures, and performance information should clearly differentiate between the two sets of performance data.

(2) Engine operating characteristics should be investigated during operation of the ATTCS, and with the operating engines at the steady-state maximum thrust level achieved following operation of the ATTCS. (Refer to the guidance material provided in paragraph 99 of this Advisory Circular.)

(3) Manual override of the ATTCS should be verified in flight test. This capability has been provided by the ability of the pilot to push the throttle levers to a higher thrust setting, for airplanes that use less than "full-throttle" for takeoff, and by activating an override switch for "firewall-type" fuel control systems. In the case of the override switch, it must be located on or forward of the power levers, and it must be easily accessible to the pilot's hand that normally controls the power lever position. It should also be demonstrated that the thrust/power level can be manually decreased at any time following ATTCS operation.

(4) A critical time period must be determined during which the probability of concurrent engine and ATTCS failure must be shown to be extremely improbable (not greater than 10^{-9} per flight hour). This critical time period is defined in Appendix I to Part 25 as being from one second before the airplane attains V_1 to a time where the actual takeoff flight path (i.e., no gradient reductions), following a simultaneous engine and ATTCS failure, would intersect the normal (i.e., engine failure at V_{FF} and no ATTCS) one-engine-inoperative actual takeoff flight path at no less than 400 feet above the takeoff surface. The probability of failure of the automatic takeoff thrust control system, itself, must be shown to be improbable (not greater than 10^{-5} per flight hour).

(5) Performance credit for an operating ATTCS is not to be taken when operations are conducted using reduced takeoff thrust methods. If the ATTCS is armed during reduced thrust takeoffs, the relevant takeoff speeds must meet the required controllability criteria of part 25 at the thrust level provided by operation of the ATTCS. It must be demonstrated that the airplane has no adverse handling characteristics and the engine(s) must not exhibit adverse operating characteristics or exceed operating limits when the ATTCS operates.

(i) The Airplane Flight Manual (AFM) must contain information, instructions, and procedures, as required, regarding the peculiarities of normal and abnormal operations when scheduling reduced thrust operations with an armed ATTCS.

(ii) Takeoff with an armed ATTCS is not restricted when airplane performance is based on an approved "derate" thrust rating that has corresponding airplane and engine limitations approved for use under all weight, altitude, and temperature (WAT) conditions.

92. PROPELLERS - § 25.905

a. Explanation. When an automatic control system for simultaneous RPM control of all propellers is installed, it should be shown that no single failure or malfunction in this system or in an engine controlling this system, will:

- (1) Cause the allowable engine overspeed for this condition to be exceeded at any time.
- (2) Cause a loss of thrust that will cause the airplane to descend below the takeoff path, established in accordance with § 25.111, if such a system is certificated for use during takeoff and climb. This should be shown

(x) Electro-Magnetic Compatibility (EMC). With all systems operating in flight, verify by observation that no adverse effects are present in the required flight systems.

(9) Inertial Navigation System (INS).

(i) Advisory Circular 25-4, "Inertial Navigation System," dated February 16, 1966, contains the basic criteria for the engineering evaluation of an inertial navigation system and offers acceptable means of compliance with the applicable regulations that contain mandatory requirements in an objective form. The engineering evaluation of an INS should also include awareness of Advisory Circular 121-13, "Self-Contained Navigation Systems (Long Range)," dated October 14, 1969, which presents criteria to be met before an operator can obtain operational approval. For flights up to 10 hours, the radial error should not exceed 2 nautical miles per hour of operation on a 95 percent statistical basis. For flights longer than 10 hours, the error should not exceed ± 20 NM cross-track or ± 25 NM along-track error. A 2 nautical mile radial error is represented by a circle, having a radius of 2 nautical miles, centered on the selected destination point. For airplanes intended for air carrier operation, reference should be made to Appendix G to Part 121 of the FAR.

(ii) The INS equipment supplier, through the applicant, will generally provide system reliability data sufficient so that additional testing for equipment reliability demonstration will not be required. Assuming adequate cooling is available for the installation, the data can be considered independent of which type of airplane was used for derivation.

(iii) Temperature. Some systems have temperature monitors built into the sensor block. When the device temperature reaches a given level, the system automatically "shuts-down." This condition could represent a common mode failure wherein insufficient cooling is provided to the multiple sensors with the consequent result that they all "trip" the temperature monitor simultaneously. Some equipment may be constructed with the cooling mechanism integral to the individual unit. Regardless of how the equipment cooling is accomplished, if the proper operation of the unit is below acceptable levels due to failures of the cooling function, then the cooling function must be addressed by analysis and demonstration, where applicable.

(iv) INS On-Airplane Test Procedure.

(A) With INS equipment off, verify all avionics equipment are operating normally.

(B) Close INS primary, heater, and excitation circuit breakers and set the mode selector to start warm-up, as required by the manufacturer's normal procedures.

(C) Alignment.

(1) Initiate INS alignment according to the manufacturer's procedures and input flight plan waypoints and record. (The airplane's present position must be loaded before the system can complete alignment. The airplane must not be moved until the system is aligned and in the "Navigate" mode, if so equipped.) Present position accuracy should be known to within 0.1 NM.

(2) Normal wind buffeting and movement of cargo and personnel will not affect alignment quality, but severe buffeting may lengthen the time required for alignment.

(3) Continue operation in the "NAV" mode until a minimum of one hour has passed.

(D) Pre-departure.

(1) Recheck that other avionics operate normally and that all systems and instruments using INS information operate correctly.

(2) Set up INS for a track from present position to any stored waypoint and check proper cockpit display unit (CDU) and instrument displays.

for all weights and altitudes for which certification is desired. A period of five seconds should be allowed from the time the malfunction occurs to the initial motion of the cockpit control for corrective action taken by the crew.

b. **Procedures.** Compliance with this policy may be shown by analysis, flight demonstration, or a combination of analysis and flight demonstration.

[93, -94, [RESERVED]]

95. **PROPELLER DEICING - § 25.979**

a. **Explanation.** None.

b. **Procedures.** If the propellers are equipped with fluid type deicers, the flow test should be conducted starting with a full tank of fluid and operated at maximum flow rate for a time period (\approx 15 min.) found operationally suitable. The operation should be checked at all engine speeds and powers. The tank should be refilled to determine the amount of fluid used after the airplane has landed.

96. **REVERSING SYSTEMS - § 25.933**

a. **Turboprop Reversing Systems - § 25.933(a)**

(1) **Explanation.**

(i) For reversers intended to be operable on the ground only, it must be shown that the airplane can be safely landed and stopped with a critical engine reverser deployed. In addition, if an undamaged reverser inadvertently becomes deployed in flight, it must be shown that it can be safely restored to a forward thrust position.

(ii) For turboprop reversing systems intended for ground and/or in-flight use, it must be shown that unwanted deployment of a critical reverser under normal operating conditions will not prevent continued safe flight and landing. Flight tests may be required to obtain aerodynamic data with the critical reverser deployed, to confirm that its deployment in the normal operating envelope will not be catastrophic to the airplane.

(2) **Procedures.**

(i) Turbine engine thrust reversers may be approved provided the following basic criteria are met:

(A) Exceptional piloting skill is not required in taxiing, or in any condition in which reverse thrust is to be used.

(B) Necessary operating procedures, operating limitations, and placards are established.

(C) The airplane control characteristics are satisfactory with regard to control forces encountered.

(D) The directional control is adequate using normal piloting skill. This is of particular importance for airplanes with aft-mounted engines, which may experience a loss of rudder effectiveness with reverse thrust. This may result in reductions in maximum reverse thrust levels (i.e., lower EPR or N₁ settings) and/or increases in reverse thrust minimum operational speeds. The stabilizing effect of the nose gear should also be investigated, particularly for the one-engine inoperative use of reverse thrust on wet runway surfaces.

(E) A determination is made that no dangerous condition is encountered in the event of the sudden failure of one engine in any likely reverse thrust operating condition throughout the airplane's approved operating envelope.

(F) The operating procedures and airplane configuration are such as to provide reasonable safeguards against engine foreign object ingestion and serious structural damage to parts of the airplane due to the reverse airflow. This is normally accomplished by specifying in the limitations section of the Airplane Flight Manual a minimum airspeed at which the thrust reversers must be retracted.

(i) **Warm-up Period (if applicable.)** All tests shall be conducted after the manufacturer's specified warm-up period.

(ii) **Display.** Check that the scope trace and sweep display move smoothly and are without gaps or objectionable variations in intensity. For color displays, verify appropriate colors and color contrast.

(iii) **Range Capabilities.** While maintaining level flight at 90 percent of maximum approved altitude of the airplane, set the radar controls so that large radar-identifiable objects such as mountains, lakes, rivers, coastlines, storm fronts, turbulence, etc., are displayed on the radar scope. Objects should be displayed at the maximum range specified by the manufacturer. Maneuver the airplane and adjust the radar controls so that tests may be conducted for the range requirements. The radar should be capable of displaying line-of-sight known prominent targets.

(iv) **Beam Tilting and Structural Clearance.**

(A) With the airplane maintained in level flight, adjust the radar controls so that large radar-identifiable targets appear on the radar scope when the antenna tilt control is adjusted for zero degrees. Maneuver the airplane so that an appropriate target appears at the dead ahead (0 degrees) bearing position. Slowly change the tilt control through an appropriate range and observe that the radar scope presentation does not change erratically, which might indicate structural interference between the radome and antenna. This interference should not occur throughout the operational speed envelope of the airplane.

(B) **Bearing Accuracy.** Fly under conditions that allow visual identification of a target, such as an island, a river, or a lake, at a range within the range of the radar. When flying toward the target, select a course from the reference point to the target and determine the error in the displayed bearing to the target on all range settings. Change the heading of the airplane in increments of 10 degrees to \pm 30 degrees maximum and verify the error does not exceed \pm 5 degrees maximum in the displayed bearing to the target.

(V) **Stability.** While observing a target return on the radar indicator, turn off the stabilizing function and put the airplane through pitch and roll movements. Observe the blurring of the display. Turn the stabilizing mechanism on and repeat the roll and pitch movements. Evaluate the effectiveness of the stabilizing function in maintaining a sharp display.

(vi) **Contour Display (Iso Echo).**

(A) If heavy cloud formations or rainstorms are reported within a reasonable distance from the test base, select the contour display mode. The radar should differentiate between heavy and light precipitation.

(B) In the absence of the above weather conditions, determine the effectiveness of the contour display function by switching from normal to contour display while observing large objects of varying brightness on the indicator. The brightest object should become the darkest when switching from normal to contour mode.

(vii) **Antenna Stability.** When installed, while in level flight at 10,000 feet or higher, adjust the tilt approximately 2-3 degrees above the point where ground return was eliminated. Put the airplane through down pitch, then roll movements. No ground return should be present.

NOTE: Roll right and left approximately 15 degrees; pitch nose down approximately 10 degrees.

(viii) **Ground Mapping.** Fly over areas containing large, easily identifiable landmarks such as rivers, towns, islands, coastlines, etc. Compare the form of these objects on the indicator with their actual shape as visually observed from the cockpit.

(ix) **Mutual Interference.** Determine that no objectionable interference is present on the radar indicator from any electrical or radio/navigation equipment, when operating, and that the radar installation does not interfere with the operation of any other equipment. Particular attention should be devoted to radar effect on electronic display systems and on localizer, glide slope, and ADF signals during approach to landing.

function. Determine that the transponder system does not interfere with other systems aboard the airplane and that other equipment does not interfere with the operation of the transponder system. There should be no dropouts, that is, when there is no return for two or more sweeps. If ring-around, spoking, or clutter appears on the ground radar scope, the airplane should switch to "low" sensitivity to reduce the interference. Uncontrollable ringing that hinders use of the ground radar should be considered unsatisfactory.

(iv) **Long Range Reception.** At 90 percent of maximum certificated altitude, perform two 360 degree turns, one to the right and one to the left, at bank angles of 8 degrees and 10 degrees with the flight pattern at least 160 NM (or 80 NM for airplanes to be operated below 18,000 ft.) from the radar facility. During these turns, the radar display should be monitored and there should be no signal dropouts (two or more sweeps). (Airspeed adjustments may be made to reduce turn radius.)

(v) **High Angle Reception.** Repeat the flight pattern and observations of (iv), above, at a distance of 50 to 70 NM from the radar facility and at an altitude of at least 35,000 ft. or within 90 percent of the maximum altitude for which the airplane is certificated or the maximum operating altitude. There should be no dropout (two or more sweeps). Switch the transponder to a code not selected by the ground controller. The airplane secondary return should disappear from the scope. The controller should then change his control box to a common system and a single slash should appear on the scope at the airplane's position. If a problem surfaces, a placard so noting shall be required.

(vi) **High Altitude Cruise.** Fly the airplane within 90 percent of its maximum certificated altitude or its maximum operating altitude beginning at a point 160 NM (or 80 NM for airplanes to be operated below 18,000 ft.) from the radar facility on a course that will pass over the radar facility. There should be no transponder dropouts (two or more sweeps) or "ring-around," except when station passage occurs or when known site features produce anomalies.

(vii) **Holding and Orbiting Patterns.**

(A) At an altitude of 2,000 feet or minimum obstruction clearance altitude (whichever is greater) above the radar antenna, and at holding pattern speeds, flaps and gear extended, fly one each standard rate 360 degree turn, right and left, at a distance of approximately 10 NM from the Air Route Surveillance Radar (ARSR) or Airport Surveillance Radar (ASR) facility. There should be no signal dropout (two or more sweeps).

(B) At an altitude of 2,000 feet or minimum obstruction clearance altitude (whichever is greater) above the radar antenna and at holding pattern speeds appropriate for the type of airplane, fly a 45 degree segment of a 10 NM orbit centered on the radar facility with gear and flaps extended. There should be no signal dropout (two or more sweeps).

(viii) **Surveillance Approach.** From an altitude of 35,000 feet or within 90 percent of the maximum certificated altitude of the airplane or the maximum operating altitude, whichever is less, perform a letdown and approach to a runway of an airport served by ASR having an Air Traffic Control Radar Beacon System (ATCRBS) facility. Alternately, a simulated approach and letdown may be made along a path parallel to, but separated three to four miles from, a vertical plane through the location of an ARSR facility. The approach should be made at the maximum normal rate of descent and in the normal approach and landing configuration for the airplane, and should continue down to an altitude of 200 feet or less above the ground radar antenna elevation. Not more than one dropout should occur for any 10 sweeps during final approach; if ring-around occurs, the flightcrew should reduce the sensitivity and the ring-around should cease.

(ix) **Altitude Reporting.** Conduct a functional test of the altitude encoder (transponder Mode "C") by comparison with ATC-displayed altitudes. Verify correspondence at several altitudes between ATC readings and the captain's altimeter, when set at or corrected to 29.92 inches of mercury.

NOTE: Throughout all tests, verify self-test function and radar interrogation reply light.

(x) **Electro-Magnetic Compatibility (EMC).** With all systems operating in flight, verify by observation that no adverse effects are present in the required flight systems.

(8) **Weather Radar System.**

(G) It is determined that the pilot's vision is not dangerously obscured under normal operating conditions on dusty or wet runways and where light snow is on the runway.

(H) For seaplanes, it is determined that the pilot's vision is not dangerously obscured by spray due to reverse airflow under normal water operating conditions.

(I) The procedure and mechanisms for reversing should provide a reverse idle setting such that, without requiring exceptional piloting skill, at least the following conditions are met:

(1) Sufficient power is maintained to keep the engine running at an adequate speed to prevent engine stalling during and after the reversing operation.

(2) The engine does not overspeed or stall during and after the reversing operation.

(3) The engine cooling characteristics should be satisfactory in any likely operating condition.

(J) For airplanes equipped with thrust reversers intended for inflight use, the effect of non-deployment of a reverser (i.e., asymmetric deployment) on airplane controllability should be investigated.

(ii) For the failed reverser demonstration tests, the following criteria are provided:

(A) The landing with a reverser deployed should be conducted with a flap setting and an airspeed such that a landing can be accomplished safely and consistently. The conditions and operating procedures to use when the landing is made with the deployed reverser must be defined and incorporated in the AFM per § 25.1585(a)(9).

(B) The restart test should be conducted at a reasonable and safe altitude and at an airspeed where the airplane can be safely controlled (approximately 200 knots). A procedure should be developed so that the reverser can be restored (if undamaged) safely, without causing unacceptable airplane controllability problems. The restarting procedure, airspeed, and airplane flight controls configuration must be incorporated in the AFM.

(3) **Aircraft Backing Using Reverse Thrust.** Limited operational approvals have been granted for the use of thrust reverser systems to back away from terminal gates in lieu of a tug pushback. These approvals are granted by the cognizant FAA Flight Standards office for each operator; the approval consisting of an amendment to the operator's Operations Specifications identifying the airplane type, the airport, and the specific gates at that airport at which reverse thrust backing may be used. Though reverse thrust backing is not specifically an airworthiness approval item, there are certain areas of concern that overlap airworthiness and operations. (These items are addressed in paragraph 242 of this AC.)

b. **Propeller Reversing Systems - § 25.933(b).**

(1) **Explanation.** None.

(2) **Procedures.** Reverse thrust propeller installations may be approved, provided the following is acceptable:

(i) A reliable means for preventing the inflight selection of a power setting below flight idle is provided.

(ii) Exceptional piloting skill is not required in taxiing or in any condition in which reverse thrust is to be used.

(iii) Necessary operating procedures, operating limitations, and placards are established.

(iv) The airplane control characteristics are satisfactory with regard to control forces encountered.

- (v) The directional control is adequate using normal piloting skill.
- (vi) A determination is made that no dangerous condition is encountered in the event of sudden failure of one engine in any likely operating condition.
- (vii) The operating procedures and airplane configuration are such as to provide reasonable safeguards against serious structural damage to the airplane due to the direct effects of the reverse airflow or any resultant buffeting.

(viii) It is determined that the pilot's vision is not dangerously obscured under normal operating conditions on dusty or wet runways and where light snow is on the runway.

(ix) It is determined that the pilot's vision is not dangerously obscured by spray due to reverse airflow under normal water operating conditions with seaplanes.

(x) The procedure and mechanisms for reversing should provide a reverse idle setting such that without requiring exceptional piloting skill at least the following conditions are met:

(A) Sufficient power is maintained to keep the engine running at an adequate speed to prevent engine stalling during and after the propeller reversing operation.

(B) The propeller does not exceed the approved speed limit of 14 CFR part 35 or the airplane-manufacturer-declared propeller speed limit during and after the propeller reversing operation.

(C) This idle setting does not exceed 25 percent of the maximum continuous rating.

(xi) The engine cooling characteristics should be satisfactory in any likely operating condition.

97. TURBOJET ENGINE THRUST REVERSE SYSTEM TESTS - § 25.924. [RESERVED]

98. TURBOPROPELLER DRAG LIMITING SYSTEMS - § 25.927.

a. Explanation: Approval of Automatic Propeller Feathering Systems. All parts of the feathering device that are integral with the propeller, or attached to it in a manner that may affect propeller airworthiness, should be considered from the standpoint of the applicable provisions of 14 CFR part 35 of the Federal Aviation Regulations (FAR). The determination of the continuing eligibility of the propeller under the existing type certificate, when the device is installed or attached, will be made on the following basis:

(1) The automatic propeller feathering system should not adversely affect normal propeller operation and should function properly under all temperature, altitude, airspeed, vibration, acceleration, and other conditions to be expected in normal ground and flight operation.

(2) The automatic device should be demonstrated to be free from malfunctioning which may cause feathering under any conditions other than those under which it is intended to operate. For example, it should not cause feathering during:

(i) Momentary loss of power; or

(ii) Approaches with reduced throttle settings.

(3) The automatic propeller feathering system should be capable of operating in its intended manner whenever the throttle control is in the normal position to provide takeoff power. No special operations at the time of engine failure should be necessary on the part of the crew in order to make the automatic feathering system operative. (See §§ 25.101, 25.111, 25.121 and 25.1501.)

(4) The automatic propeller feathering system installation should be such that not more than one engine will be feathered automatically, even if more than one engine fails simultaneously.

airplane on a station radial (within 5 degrees). The DME should continue to track with no unlocks to a range of 160 NM (80 NM for airplanes not to be operated at altitudes above 18,000 ft.).

(iv) Long Range Reception. Perform two 360 degree turns, one to the right and one to the left, at a bank angle of 8 to 10 degrees at not less than 160 NM (80 NM for airplanes not to be operated above 18,000 ft.) from the DME facility. A single turn will be sufficient if the antenna installation is symmetrical. There should be no more than one unlock, not to exceed one search cycle (maximum 35 seconds) in any five miles of radial flight. Tests may be conducted up to a maximum certificated altitude.

(v) High Angle Reception. Repeat the flight pattern and observations of (iv) above at a distance of 50-70 NM (20 to 30 NM for airplanes not to be operated above 18,000 ft.) from the DME facility and at an altitude of at least 35,000 ft. (or to within 90 percent of the maximum altitude for which the airplane is certificated or the maximum operating altitude).

(vi) Penetration. From an altitude of at least 35,000 ft. (or the airplane maximum altitude, if lower), perform a letdown directly toward the ground station using normal maximum rate of descent procedures to a DME facility, so as to reach an altitude of 5,000 ft. above the DME facility 5 to 10 NM before reaching the DME facility. The DME should continue to track during the maneuver with no unlocks.

(vii) Orbiting. At an altitude of 2,000 ft. above the terrain, at holding pattern speeds appropriate for the type of airplane and with the landing gear extended, fly at least 15 degree sectors of left and right 35 NM orbital patterns around the DME facility. The DME should continue to track with no more than one unlock, not to exceed one search cycle, in any 5 miles of orbited flight.

(viii) Approach. Make a normal approach to a field with a DME. The DME should track without an unlock (station passage excepted).

(ix) Electro-Magnetic Compatibility (EMC). With all systems operating in flight, verify by observation that no adverse effects are present in the required flight systems.

(7) Transponder Equipment.

(i) The ATC transponder system should furnish a strong and stable return signal to the interrogating radar facility when the airplane is flown in straight and level flight throughout the airspace within 160 NM of the radar station, from radio line-of-sight to within 90 percent of the maximum altitude for which the airplane is certificated or to the maximum operating altitude. Airplanes to be operated at altitudes not exceeding 18,000 ft. should meet the above requirements to only 80 NM.

(ii) When the airplane is flown in the following maneuvers within the airspace described above, the dropout time should not exceed 36 seconds:

(A) In turns at bank angles up to 10 degrees (skidding turns may be used to minimize turn radius).

(B) Climbing and descending at typical climb and descent altitudes.

(iii) Climb and Distance Coverage.

(A) Beginning at a distance of at least 10 NM from, and at an altitude of 2,000 ft. above that of the radar facility, and using a transponder code assigned by the Air Route Traffic Control Center (ARTCC), fly on a heading that will pass the airplane over the facility. Operate the airplane at its normal maximum climb attitude up to within 90 percent of the maximum altitude for which the airplane is certificated, or to a maximum operating altitude, maintaining the airplane at a heading within 5 degrees from the radar facility. After reaching the maximum altitude for which the airplane is certificated, fly level at the maximum altitude to 160 NM (or 80 NM for airplanes to be operated below 18,000 ft.) from the radar facility.

(B) Communicate with the ground radar personnel for evidence of transponder dropout. During the flight, check the "ident" mode of the ATC transponder to assure that it is performing its intended

- (5) The automatic propeller feathering system installation should be such that normal operation may be regained after the propeller has begun to feather automatically.
- (6) The automatic propeller feathering system installation should incorporate a switch, or equivalent means, by which to make the system inoperative.

b. Procedures:

(1) Propeller Feathering System Operational Tests.

- (i) Tests should be conducted to determine the time required for the propeller to change from windmilling (with the propeller controls set for takeoff) to the feathered position at the takeoff safety speed, V_2 .
- (ii) The propeller feathering system should be tested to demonstrate non-rotation or as a minimum, non-hazardous rotation at up to 1.2 times the maximum level flight speed, with one engine inoperative or the speed employed in emergency descents, whichever is higher, with:

- (A) The critical engine inoperative;
- (B) Wing flaps retracted;
- (C) Landing gear retracted; and
- (D) Cowl flaps (if applicable) closed.

(iii) A sufficient speed range should be covered to assure that the propeller feathering angle, established on the basis of the high speed requirement, will not permit hazardous reverse rotation at the lower speeds. In addition, the propeller should not inadvertently unfeather during these tests.

(iv) In order to demonstrate that the feathering system operates satisfactorily, the propeller should be feathered and unfeathered at the maximum operating altitude established in accordance with § 25.1527. The following data should be recorded:

- (A) Time to feather the propeller at the one-engine-inoperative cruising speed;
- (B) Time to unfeather the propeller to the minimum declared governing speed at maximum operating altitude (note that some driftdown may occur) and one-engine-inoperative cruising speed;
- (C) Altitude of propeller feathering tests; and
- (D) Ambient air temperature of propeller feathering tests.

(v) In order to demonstrate that the feathering system operates satisfactorily, the propeller should be feathered at the condition within the airplane operating envelope that is critical for the propeller.

99. TURBINE ENGINE OPERATING CHARACTERISTICS - § 25.939(a).

a. Explanation. The turbine engines of a transport category airplane must continue to operate safely during normal and emergency operation within the range of operating limitations of the airplane. Generally, compliance with § 25.939(a) can be determined to some extent while ascertaining compliance with other Part 25 requirements, such as performance, controllability, maneuverability, and stall speed characteristics. Turbine engines should be stable in their operation and run free of adverse characteristics throughout the normal flight envelope. Certain adverse characteristics are allowed in specific flight regimes if they do not present a hazardous condition.

b. Reference. See Advisory Circular 25-939-1, "Evaluating Turbine Engine Operating Characteristics," dated March 19, 1986, for comprehensive guidance in the evaluation of turbine engine operating characteristics to show compliance with the requirements of § 25.939(a), only. The referenced advisory circular does not provide guidance for compliance with § 25.939(c), which addresses inlet compatibility.

(iv) Bearing Accuracy. Using a properly operating directional gyro, and a ground checkpoint whose location is known with respect to the ground-based station to which the ADF is tuned, fly the airplane over the ground checkpoint at a minimum of six airplane headings (relative to the station to which the ADF is tuned), including headings of 0 degrees, 180 degrees, and headings 15 degrees each side thereof. Determine that the compensated or otherwise corrected ADF bearing indication is not in error by more than ± 5 degrees at any of the six headings. Repeat the foregoing procedure but fly at a minimum of six headings relative to the ground based station, including 45 degrees, 90 degrees, 135 degrees, 225 degrees, 270 degrees, and 315 degrees. In this case, the compensated or otherwise corrected bearing indication should not be in error by more than ± 10 degrees at any of these six headings.

NOTE: The distance between the ground checkpoint and the ground-based station used should be at least one-half of the service range of that station.

(v) Indicator Response. With the ADF indicating station dead ahead, switch to a station having a relative bearing of 175 degrees. The indicator should indicate within ± 3 degrees of the bearing in not more than 10 seconds.

(vi) Antenna Mutual Interaction. If the ADF installation being tested is dual, check for coupling between the antennae by using the following procedures.

(A) With #1 ADF receiver tuned to a station near the low end of the ADF band, tune the #2 receiver slowly throughout the frequency range of all bands and determine whether the #1 ADF indicator is adversely affected.

(B) Repeat (A) with the #1 ADF receiver tuned to a station near the high end of the ADF band.

(vii) Electro-Magnetic Compatibility (EMC). With all systems operating in flight, verify by observation that no adverse effects are present in the required flight systems.

(viii) Precipitation Static. The effect of precipitation static should be considered. This type of static is normally found in areas of high cirrus clouds, dry snow, dust storms, etc.

(6) Distance Measuring Equipment (DME).

(i) Airplanes to be operated above 18,000 ft. The DME system should continue to track without dropouts when the airplane is maneuvered throughout the airspace within 160 NM of the VORTAC station and at altitudes above radio line-of-sight up to the maximum altitude for which the airplane is certificated. This tracking standard should be met with the airplane:

- (A) In cruise configuration.
- (B) At bank angles up to 10 degrees (skidding turns may be used to minimize turn radius).
- (C) Climbing and descending at normal maximum climb and descent attitudes.
- (D) Orbiting a DME facility.
- (E) Providing clearly intelligible (visual/aural) identification of the DME facility.

(ii) Airplanes to be operated at altitudes below 18,000 ft. The DME system should perform as specified in paragraph (i) above, except that the maximum distance from the DME facility need not exceed 80 NM.

(iii) Climb and Maximum Distance. Determine that there is no mutual interference between the DME system and other equipment aboard the airplane. Beginning at a distance of at least 10 NM from a DME facility and at an altitude of 2,000 ft. above the DME facility, fly the airplane on a heading so it will pass over the facility. At a distance of 5 to 10 NM beyond the DME facility, operate the airplane at its normal maximum climb attitude, up to an altitude of 35,000 ft. or to within 90 percent of the maximum certificated altitude, maintaining the

c. Inlet Compatibility - § 25.939(c).

(1) Explanation. Section 25.939(c) requires substantiation that the engine inlet systems on turbine engines not cause harmful vibration to the engine as a result of airflow distortion. This should be verified in both static and transient thrust conditions.

(2) Procedures. Compliance with § 25.939(c) may require special instrumentation of the inlet itself, or the engine's most critical component (i.e., fan blades). Interlocks permit the applicant to verify that the installed airflow distortion patterns are within the limits established by the engine manufacturer. In addition, accelerometer and/or strain gauge data could be acquired in flight tests to verify that vibration and stress level limits are not exceeded during operation in the normal flight envelope."

100. INLET, ENGINE, AND EXHAUST COMPATIBILITY - § 25.941. [RESERVED]

$$\text{Upper limit} = \frac{1775}{\text{Ground Speed in Knots}} \text{ (secs.)}$$

$$\text{Lower limit} = \frac{1183}{\text{Ground Speed in Knots}} \text{ (secs.)}$$

(ii) If a high/low sensitivity feature is installed and selected, the marker beacon annunciator light and audio will remain on longer than when in low sensitivity.

(iii) The audio signal should be of adequate strength and sufficiently free from interference to provide positive identification.

(iv) As an alternative procedure, cross the outer marker at normal ILS approach altitudes and determine adequate marker aural and visual indication.

(v) Illumination shall be adequate in bright sunlight and at night.

(vi) Electro-Magnetic Compatibility (EMC). With all systems operating in flight, verify by observation that no adverse effects are present in the required flight systems.

(5) Automatic Direction Finding System (ADF).

(i) Receiving Function. Determine that, when flying toward or away from a station with all required electrical and radio equipment in operation, the average bearing pointer indications are such that they present a usable bearing at the below-listed distances, during day light hours (between one hour after local sunrise and one hour before local sunset) and when atmospheric disturbances are at a minimum. The amplitude of pointer oscillation is relatively unimportant, provided a valid direction to the station can be determined. At the distances shown below, the tone audio identification of the station to which the receiver is tuned shall be intelligible.

(ii) General Information.

Classification of LEMF Radio Beacons in U.S. National Service

<u>Class</u>	<u>Power (watts)</u>
Comlo	under 25
MH	under 50
H	50-1999
HH	2000 or more

<u>Facility</u>	<u>Range</u>
Compass Locators	15 Nautical miles
Transmitters <50 watts	25 Nautical miles
Transmitters 100-200 watts	50 Nautical miles
Transmitters 200-400 watts	60 Nautical miles
Transmitters over 400 watts	75 Nautical miles

NOTE: In areas where the known service range is less than the above distances, the actual shorter range may be used. It is advisable to ascertain the operating status of the facility to be used, prior to flight testing.

(iii) Pointer Reversal. While flying the airplane directly over a properly operating ground-based station, note the airplane's altitude and measure the complete pointer reversal time by using a stopwatch. Using the airplane's true ground speed and the airplane's altitude, determine that the pointer reversal occurred within a circular area centered over the station, having a radius equal to the altitude being flown. Partial reversals that lead or lag the main reversal are permissible.

establish localizer on-course operation. The localizer deviation indicators should direct the airplane to the localizer on-course. Perform this maneuver with both a left and a right needle deflection. Continue tracking the localizer until over the transmitter. Acceptable front course and back course approaches should be conducted to 200 ft. or less above the threshold.

(iv) Electro-Magnetic Compatibility (EMC). With all systems operating in flight, verify by observation that no adverse effects are present in the required flight systems.

(3) Glideslope Systems.

(i) These flight tests may be reduced if adequate antenna radiation pattern studies have been made, and those studies show the patterns to be without significant holes. A significant hole is one that is greater than 10 db from the average within 30 degrees horizontally and 15 degrees vertically of the nose of the airplane.

(A) The signal input to the receiver should be of sufficient strength to keep the warning flags out of view at all distances up to 10 NM from the final approach fix. This performance should be demonstrated at all airplane headings between 30 degrees right and left of the localizer course. The deviation indicator should properly direct the airplane back to the glideslope path when the airplane is above or below the path.

(B) Interference with the navigation operation should not occur with all airplane equipment operating and all pulse equipment transmitting. There should be no interference with other equipment as a result of glideslope operation.

(ii) Glideslope Interception. Fly the localizer course inbound, at the altitude at which the glideslope beam intercepts the final approach fix, and at least 10 NM from the fix. The glideslope deviation indicator should be centered (± 25 percent of full scale) at the final approach fix. There should be no flags from the time the needle leaves the full scale fly-up position until it reaches the full scale fly-down position.

(iii) Glideslope Tracking. While tracking the glideslope, maneuver the airplane through normal pitch and roll attitudes. The glideslope deviation indicator should show proper operation with no flags. Acceptable approaches to 100 ft. or less above the threshold should be conducted.

(iv) Electro-Magnetic Compatibility (EMC). With all systems operating in flight, verify by observation that no adverse effects are present in the required flight systems.

(4) Marker Beacon System.

(i) In low sensitivity, the marker beacon annunciator light should be illuminated for a distance of 2,000 to 3,000 ft. when flying at an altitude of 1,000 ft. on the localizer centerline in all flap gear configurations.

NOTE: An acceptable test to determine distances of 2,000 to 3,000 ft. is to fly at a ground speed listed in Table I and time the marker beacon light duration.

Table I

Altitude = 1,000 ft. (AGL)	
Ground Speed (Knots)	Light Time (Seconds)
2,000 ft.	3,000 ft.
90	13
110	11
130	9
150	8
	20
	16
	14
	12

For ground speeds other than tabled values, the following formulas may be used:

101. NEGATIVE ACCELERATION - § 25.943.

a. Explanation. Section 25.943 requires that no hazardous malfunction of an engine, auxiliary power unit (APU), or any component or system associated with their operation, should result from airplane operation at negative accelerations. A hazardous malfunction in this case is considered to be one that causes loss or sustained malfunction of the engine or APU, or improper operation of the engine accessories or systems. This requirement can be satisfied by flight test demonstrations that take into consideration the critical airplane, engine and APU configurations. The range of negative accelerations to be tested is prescribed by the flight envelope for the airplane, as defined in § 25.333. The duration of the negative acceleration excursions is intended to represent anticipated non-normal operational events such as atmospheric upsets, collision avoidance maneuvers, etc.

b. Procedures.

- (1) In conducting negative acceleration tests, consideration should be given to engine accessory configurations, and critical levels of fuel and oil.
- (2) Accelerations should be measured as close as practicable to the airplane's center of gravity position.
- (3) With the engines operating at maximum continuous thrust, and the APU operating with normal load (if flight operable), the airplane should be flown at a critical negative acceleration within the flight envelope. The duration of each test condition should be a minimum of 7 seconds between 0 and -1.0g, with a total accumulation of 20 seconds of negative acceleration operation.
- (4) Test data should be analyzed with regard to maintaining adequate fuel flow to the engines and APU, and maintaining lubrication of critical components.
- (5) Test planning should consider that sufficient altitude be available to conduct a suction feed reflight in the unlikely event of an all-engine flameout, in which case the tank pump feed lines will become uncovered and air will enter each feed line.

102. THRUST OR POWER AUGMENTATION SYSTEM § 25.945. [RESERVED]

Section 2. FUEL SYSTEM

[103 - 108.] [RESERVED]

109. UNUSABLE FUEL SUPPLY - § 25.959.

a. Explanation.

(1) The purpose of this test is to determine, for each fuel tank, the quantity of fuel that is not available to the engines, as specified in § 25.959. The unusable fuel quantity is considered as the quantity of fuel that can be drained from the fuel tank sump with the airplane in its normal level ground attitude after a fuel tank unusable fuel test has been performed.

(2) A fuel tank that is designed not to feed the engines under all flight conditions need be tested only for the flight regime for which it is designed (e.g. cruise conditions). Tanks that are not subject to aerostatic effects of flight, such as wing bending or tank flexing, may have their unusable fuel quantity determined during a ground test. Suitable instructions on the conditions under which the tank may be used should be provided in the Airplane Flight Manual (AFM). It must be noted that the Part 25 requirements, such as fuel flow (§ 25.955(a)(2)) and fuel quantity gauge calibration (§ 25.1553), are also related to the unusable fuel quantity. These other requirements must also be considered when the unusable fuel quantity is being determined for each fuel tank.

b. Procedures.

(1) The fuel system and tank geometry should be analyzed to determine the critical conditions for the specific tanks being considered (i.e., main and auxiliary or cruise tanks). The analysis should determine the amount of unusable fuel as a function of airplane attitudes (i.e., pitch and roll), including those encountered when executing sideslips and dynamic maneuvers such as go-around/pitch-up and acceleration. Particular attention should be directed toward the fuel tank or cell geometry and orientation with respect to the longitudinal axis of the airplane and location of the fuel tank outlets (i.e., fuel pump inlets or pickups). Care should be taken in planning how the critical attitude conditions are tested, so that the test procedure does not result in a non-conservative unusable fuel quantity.

(2) The term "most adverse fuel feed condition" is not intended to include radical or extreme conditions not likely to be encountered in operation. Judgment must be used in determining what maneuvers are appropriate to the type of airplane being tested. The test conditions should be selected using good judgment with regard to the kind of conditions the airplane under test will be subjected to in operation.

(3) Airplane attitude limitations may be used as a means of reducing the unusable fuel quantity, provided it is demonstrated that likely operational flight maneuvers can be accomplished with those attitude limits. Nose down pitch attitude should not be less than that for normal descent, approach, and landing maneuvers. Nose up pitch attitude consistent with a normal go-around condition, or a minimum of 10 degrees nose up, whichever is less, must be considered. Roll attitude limitations should not be less than that required to enter a normal traffic pattern, intercept the final approach course, and land with a 10-knot crosswind.

(4) After the most adverse fuel feed condition and the critical flight attitude have been determined for the specific fuel tanks being considered, the appropriate flight tests should be conducted. The flight testing should investigate the effects of the following:

- (i) Steady state sideslips anticipated during operation with the airplane in both the approach and landing configurations.
- (ii) For those airplanes capable of high roll and pitch rates, abrupt maneuvers should be considered.
- (iii) A go-around condition at maximum acceleration and maximum rotation rate to the maximum pitch attitude should be considered.

airplanes to be operated below 18,000 ft.) from the VOR facility. Signal dropout should not occur as evidenced by the malfunction indicator appearance. Dropouts that are relieved by a reduction of bank angle at the same relative heading to the station are satisfactory. The VOR identification should be satisfactory during the left and right turns. Skidding turns may be used to minimize turn radius.

(iv) High Angle Reception. Repeat the turns described in (iii) above, but at a distance of 50 to 70 NM (20 to 30 NM for airplanes not to be operated above 18,000 ft.) from the VOR facility and at an altitude of at least 35,000 ft. (or to within 90 percent of the maximum certified altitude of the airplane or the maximum operating altitude).

(v) Enroute Station Passage. Verify that the TO-FROM indicator correctly changes as the airplane passes through the cone of confusion above a VOR facility.

(vi) VOR Approach. Conduct VOR approach(es) with gear and flaps down. The facility should be 12-15 NM behind the airplane with the approach conducted after a 30 degree radial change over the station. Use sufficient maneuvering in the approach to assure the signal reception is maintained during beam tracking.

(vii) Electro-Magnetic Compatibility (EMC). With all systems operating in flight, verify by observation that no adverse effects are present in the required flight systems.

(viii) Identifier. The audio identifier should be checked, as should the decoded ident, if equipped with a digital bus.

(ix) Station tuning. Evaluate various methods of station tuning, including automatic and manually through a Flight Management System (FMS). Also, a check for proper indications for loss of signal or receiver failure should be done.

(2) Localizer Systems.

(i) These flight tests may be reduced if adequate antenna radiation pattern studies have been made, and those studies show the patterns to be without significant holes. A significant hole is one that is greater than 10 decibels (dB) from the average within 30 degrees horizontally and 15 degrees vertically of the nose of the airplane

(A) The signal input to the receiver, presented by the antenna system, should be of sufficient strength to keep the malfunction indicator out of view when the airplane is in the approach configuration (landing gear extended-approach flaps) and at least 25 NM from the station. This signal should be received for 360 degrees of airplane heading at all bank angles up to 10 degrees left or right, at all normal pitch attitudes, and an altitude of approximately 2,000 ft.

(B) Satisfactory results should also be obtained at bank angles up to 30 degrees, when the airplane heading is within 60 degrees of the inbound localizer course. Results should be satisfactory with bank angles up to 15 degrees on headings from 60 degrees to 90 degrees of the localizer inbound course, and up to 10 degrees bank angle on headings from 90 degrees to 180 degrees from the localizer inbound course.

(C) The deviation indicator should properly direct the airplane back to course when the airplane is right or left of course.

(D) The station identification signal should be of adequate strength and sufficiently free from interference to provide positive station identification, and voice signals should be intelligible with all electrical equipment operating and pulse equipment transmitting.

(ii) Localizer Intercept. In the approach configuration and at a distance of at least 25 NM from the localizer facility, fly toward the localizer from course, inbound, at an angle of at least 50 degrees. Perform this maneuver from both left and right of the localizer beam. No flags should appear during the time the deviation indicator moves from full deflection to on-course.

(iii) Localizer Tracking. While flying the localizer inbound and not more than 5 miles before reaching the outer marker, change the heading of the airplane to obtain full needle deflection; then fly the airplane to

(iv) If the Flight Management System (FMS) data base or operational program can be accessed in flight by ACARS, exercise all interface functions to demonstrate performance of the intended function.

(v) ACARS should not cause interference with the operation of any of the airplane's radio/navigation systems. Particular attention should also be devoted to non-interference with flight guidance takeoff and approach functions, particularly autoland, since these are likely flight regimes for ACARS transmissions.

(5) Selective Calling System (SELCAL). Verify performance of intended function of the SELCAL by receipt of VHF and HF (if appropriate) calls from ground stations.

(6) Satellite Communications (SATCOM). [RESERVED]

(7) Portable Battery-Powered Megaphones.

(i) Conduct hearing range and intelligibility tests on the airplane to demonstrate that the amplified speech is heard and clearly understood throughout the interior cabin region served by the megaphones, with the engines off and with all significant conditions associated with an accident (including the presence of passengers and the normally-attendant confusion din) appropriately simulated.

(ii) Verify that the megaphone reliably performs its intended function and is designed:

(A) For ease of handling, and use, with one hand;

(B) With sufficient acoustical feedback suppression; and

(C) With a volume control.

c. Procedures – Navigation.

(1) Very High Frequency Omnidirectional Range (VOR) Systems.

(i) These flight tests may be reduced if adequate antenna radiation pattern studies have been made and these studies show the patterns to be without significant holes (with the airplane configurations used in flight, i.e., flaps, landing gear, etc.). Particular note should be made in recognition that certain propeller r.p.m. settings may cause modulation of the course deviation indication (prop-modulation). This information should be presented in the Airplane Flight Manual (AFM).

(A) The airborne VOR system should operate normally with warning flags out of view at all headings of the airplane (wings level) throughout the airspace within 160 NM of the VOR facility (for airplanes to be operated above 18,000 ft.), from the radio line-of-sight altitude to within 90 percent of the maximum altitude for which the airplane is certified or the maximum operating altitude.

(B) The accuracy determination should be made such that the indicated reciprocal agrees within 2 degrees. The test should be conducted over at least two known points on the ground such that data are obtained in each quadrant. Data should correlate with the ground calibration and in no case should the absolute error exceed ± 6 degrees. There should be no excessive fluctuation in the course deviation indications.

(ii) Enroute Reception. Fly from a VOR facility rated for high altitude along a radial at an altitude of 35,000 ft. (or to within 90 percent of the airplane maximum certificated altitude or the maximum operating altitude) to a range of 160 NM (80 NM for airplanes not to be operated above 18,000 ft.). The VOR warning flag should not come into view, nor should there be deterioration of the station identification signal. The course width should be 20 degrees ± 5 degrees (10 degrees either side at the selected radial). If practical, perform an enroute segment on a doppler VOR station to verify the compatibility of the airborne unit. Large errors have been found when incompatibility exists.

(iii) Long Range Reception. Perform a right and/or left 360 degree turn at a bank-angle of at least 10 degrees, at an altitude just above the radio line-of-sight, and at a distance of at least 160 NM (80 NM for

(iv) Effects of turbulence on unusable fuel quantity should be considered.

(v) If the airplane includes a low fuel quantity warning system, it should be demonstrated that the airplane can complete a go-around, approach, and return to landing, without fuel feed interruption, using the normal go-around pitch attitude; this should include go-arounds accomplished with the aid of automated flight guidance systems.

(5) If airplane attitude limitations are employed to reduce the unusable fuel quantity, those attitude limitations must be published in the AFM as limits for flight maneuvers after the low fuel warning light/message illuminates. This will provide insurance that the fuel remaining that is above the unusable quantity can be used without risk of fuel feed interruption to the engines. Flight tests must be conducted to confirm that the proposed pitch attitude limit:

(i) is practical in terms of airplane flight characteristics for accomplishing a go-around; and

(ii) will not result in lift and drag characteristics that will increase the time and/or fuel quantity necessary to complete the go-around to a point where the fuel remaining is less than the unusable fuel quantity.

(6) If fuel pump failure enroute would result in a significant reduction in usable fuel, the unusable fuel supply test should include a determination of this quantity. The effects of pump failure on the unusable fuel quantity should be presented in the AFM so that the flightcrew can take the reduction in usable fuel into account for flight planning purposes.

(7) Auxiliary fuel tanks and fuel transfer tanks designed or restricted for use during cruise flight only (not suitable for takeoff and landing) should be tested for unusable fuel quantity by appropriate investigation of the cruise environment. This should include reasonable turbulence levels, asymmetrical power, adverse fuel feed/transfer configuration, etc.

110. FUEL SYSTEM HOT WEATHER OPERATION – § 25.961.

a. Explanation.

(1) A flight test is normally necessary to complete the hot weather operation tests. If a ground test is performed, it should closely simulate flight conditions. If a hot fuel climb test is elected, hot weather fuel systems tests should be conducted with hot fuel in the tanks normally used for takeoff and landing, and with the maximum number of engines drawing fuel from each tank, as allowed in the airplane flight manual, to obtain the maximum anticipated fuel flow through the lines. In the case of symmetrical fuel tank systems, the tests may be confined to one of each such system. Critical fuel that is unweathered or has not been exposed to long storage periods should be used during the tests. This ensures that the fuel has the maximum Reid vapor pressure (RVP) for which approval is requested. Fuel samples should be taken from the fuel tank prior to the test; for typical JET B (JP-4) type fuels, a minimum RVP of 3.0 has been required. The fuel temperature, just prior to takeoff, should be as close as practical to the maximum value for which operational approval is sought, but not less than 110° F as required by § 25.961(a)(5). If the fuel must be heated to this temperature, caution should be taken to prevent overheating during the process.

(2) The desirable outside ambient air temperature at the airport from which the tests are being conducted should be at least 85° F. If tests are performed in weather cold enough to interfere with test results, steps should be taken to minimize the effects of cold temperatures. This may be accomplished by insulating fuel tank surfaces, as appropriate, fuel lines, and other fuel system components from cold air to simulate hot-day conditions. It should not be necessary to provide additional heat to the fuel after the original fuel sample is heated to temperature during the hot weather tests. However, if the fuel is used as the cooling medium for any heat exchangers, the maximum heat available to the fuel should be considered.

(3) If auxiliary pumps are being considered for use as emergency pumps, they should be inoperative. This test may be used to establish the maximum pressure altitude for operation with these

pumps off. A fuel pressure failure is considered to occur when the fuel pressure decreases below the minimum prescribed by the engine manufacturer, or the engine does not operate satisfactorily.

b. Test Procedures and Required Data.

(1) The fuel temperature, just prior to takeoff, should be as close as practical to the maximum value for which operational approval is sought. If heating of the fuel is required, a takeoff and climb should be made as soon as possible after the fuel in the tank has been heated to avoid cooling of the fuel.

(2) Power settings should be maintained at the maximum approved levels for takeoff and climb in accordance with § 25.961(a)(2). The airspeed during the climb should not exceed that speed used in demonstrating the requirements specified in § 25.961(a)(4). While § 25.961(a)(3) requires full fuel tanks for this test, experience has shown that may not always be the most critical fuel load. Generally, full tanks result in the maximum head pressure over the tank pumps. A lesser tank quantity results in a lesser head pressure. A greater rate of climb results in more air per unit time being released in the feed lines during the climb. Rate of climb is dictated primarily by airplane weight; however, airplane weight is a combination of payload and fuel state, and thus an analysis may be required to determine the critical combination of fuel quantity state and airplane weight that is operationally likely to occur.

(3) If the engines are normally operated with the auxiliary/emergency pumps "off," they should remain "off" until fuel pressure failure occurs. Restoration of fuel pressure should be noted and the climb continued to the maximum operating altitude selected by the applicant for certification. If a lower altitude is substantiated, appropriate limitations should be noted in the AFM.

(4) The tests should be conducted with the fuel system operating and configured normally, in accordance with the normal procedures outlined in the AFM. The following data should be recorded at reasonable time intervals:

- (i) fuel temperature in the tank
- (ii) engine fuel pressure, measured at the engine/airplane interface, at the start of the test and during climb (note any pressure failure, fluctuation, or variation)
- (iii) main and auxiliary/emergency fuel pump operation, as applicable
- (iv) pressure altitude
- (v) ambient air temperature
- (vi) airspeed
- (vii) engine power setting and operating parameters (i.e., engine pressure ratio, gas generator speed, fan speed, exhaust gas temperature, fuel flow, etc.)
- (viii) comments on engine operation
- (ix) fuel quantities in fuel tanks
- (x) fuel grade or designation determined prior to test
- (xi) airplane pitch and roll attitudes

(5) If significant fuel pressure fluctuations occur during testing of the critical flight conditions, but pressure failure does not occur, additional testing should be considered to determine that pressure failure may not occur during any expected operating mode. Also, the fuel system should be evaluated for vapor formation when switching from different fuel feed configurations, or at low fuel flow and idling approach and landing.

(v) High Angle Reception. Repeat the above test at a distance of 50 to 70 NM from the ground station and at an altitude of 35,000 ft., or the maximum operating altitude of the airplane (20 to 30 NM for airplanes to be operated below 18,000 ft.).

(vi) Approach Configuration. With the landing gear extended and the flaps in the approach configuration, demonstrate intelligible communications between the airplane and the ground facility.

(vii) Electro-Magnetic Compatibility (EMC). With all systems operating in flight, if practicable, verify, by observation, that no adverse effects are present in the required flight systems.

(2) HF Systems.

(i) Acceptable communication should be demonstrated by contacting one or more ground stations on several of the frequencies allowed by HF propagation conditions. Distances may vary from 100 to several thousand NM, and at least one over-the-horizon communication link should be established via ionospheric propagation. When a new HF antenna installation is being evaluated, the test should be conducted at an altitude of not less than 90 percent of the maximum altitude to check for possible corona arcing at the antenna.

(ii) The effect of precipitation static should be considered. This type of static is normally found in areas of high cirrus clouds, dry snow, dust storms, etc.

(iii) Electro-Magnetic Compatibility (EMC) should be evaluated with all systems operating in flight, if practicable, to verify, by observation, that no adverse effects are present in the required flight systems.

(3) Audio Systems.

(i) Acceptable communications should be demonstrated for all audio equipment, including microphones, speakers, headsets, interphone amplifiers, and public address systems. If provisions for passenger entertainment are included, adequate override of the music/audio by the cockpit crew attendants, or by prerecorded announcements, should be demonstrated. All modes of operation should be tested, including operation during emergency conditions (e.g., emergency descent with oxygen masks) with all airplane engines running, all airplane pulse equipment transmitting, and all electrical equipment operating. Flight tests, except as described in (ii) below, are generally not necessary unless airstream noise is considered a factor or unless excessive feedback with cockpit speakers is encountered during ground tests, which makes cockpit sound levels questionable.

(ii) If a flight evaluation of the passenger address (PA) system is deemed to be necessary (or the prudent thing to do), PA announcements should be made from each handset station, including the cockpit, with the airplane operated at mid to high altitude at speeds approaching V_{MO}/M_{MO} .

(iii) Electro-Magnetic Compatibility (EMC). With all systems operating during flight, verify, by observation, that no adverse effects are present in the required flight systems.

(4) ARINC Communication Addressing and Reporting System (ACARS). ACARS is an addressable VHF digital data link system that permits communication between the airplane and a ground-based facility. The display medium is a printer and/or electronic multifunction display.

(i) Acceptable performance should be demonstrated by verifying that pre-flight loaded data is retained in memory during power interrupts generated during transfers from ground to APU power, from APU to engine generators, and during cross-the-switching in all possible combinations.

(ii) Verify that simultaneous transmission of ACARS data and VHF voice communication is satisfactory and is free of interference between the two independent VHF systems, considering frequency and VHF antenna isolation. Exercise all possible switching combinations.

(iii) If the Selective Calling System (SELCAL) can be initiated by the ground station via the ACARS data link, demonstrate performance of that function by observing that the cockpit aural and visual indications are proper.

[111. - 116.] [RESERVED]

117. FUEL-TANK VENTS AND CARBURETOR VAPOR VENTS - § 25.975.

a. Explanation. Approval of Fuel Tank Vents (§ 25.975(a)).

(1) The tank venting arrangement must prevent siphoning of fuel during normal operation. Also the venting capacity and vent pressure levels must maintain acceptable differences of pressure between the interior and exterior of the tank during:

- (i) Normal flight operation;
- (ii) Maximum rate of ascent and descent; and
- (iii) Refueling and defueling.

(2) No vent or drainage provision may end at any point where the discharge of fuel from the vent outlet would constitute a fire hazard, or where the discharge of fumes could enter personnel compartments.

(3) Each carburetor vent system must have means to avoid stoppage by ice.

b. Procedures.

(1) Tests should be conducted to ensure that no hazardous quantities of fuel will be siphoned onboard during any likely maneuvers encountered during normal operations. Maneuvers that may require evaluation include, but are not necessarily limited to, the following:

- (i) Taxi turns and turning takeoff maneuvers with fuel tanks filled to the maximum volume (below the required 2 percent expansion space) allowed by the type design, including consideration of tolerances in the volumetric shutoff level. Typically, left and right-hand turns are conducted in a "figure eight" maneuver, followed by a maximum pitch and ascent rate takeoff;
- (ii) Maximum climb power ascent at high climb angles;
- (iii) Simulated turbulent air oscillations at or near the natural yawing and pitching frequency of the airplane;
- (iv) Rapid descent with high initial pitch-down rate;
- (v) In-flight power-up turns; and
- (vi) Sideslip maneuvers on approach.

(2) The changes in tank secondary barrier cavity pressure during all airplane maneuvers, including emergency descent, must be accounted for in the design of the fuel tank. Bladder type tanks may be critical under emergency descent conditions, depending on the cavity vent line sizing. The vent/drain configuration must provide the required positive and negative pressure relief between the outer shell and the bladder or inner wall, to prevent collapse or over-expansion of the inner tank. Depending on the location of the overboard vent/drain exit and the airflow characteristics around the exit or exit mast, a flight test may be required to evaluate the ascent and/or emergency descent characteristics of the cavity vent system with the airplane in both the "clean" and "wheels and flaps down" configuration.

(3) Verification that liquid discharge from the vent mast will flow clear of the airplane, not attaching itself to any airplane surface or re-entering any compartment of the airplane, may need to be accomplished by impingement tests conducted in flight. Small discharges of fuel from the fuel tank vent outlet have been acceptable, provided the fuel discharges clear of the airplane and does not result in siphoning of fuel from the tank. This can be accomplished using dyed fluid and/or coating the surfaces required to be free of impingement with powder compounds that will be washed away if contacted by liquid.

(5) The requirement for demonstrating safe operation should normally include induced failures during flight. The requirement for failure demonstrations is also an outgrowth of the analysis and laboratory test results submitted by the applicant and is a result of the particular design being evaluated (e.g., consideration should be made for multiple channel systems specifically designed to be self-adaptive to failure conditions). Performance and malfunctions testing should include those flight conditions and airplane configurations that have been identified to be the most critical by analysis and/or test. Such items as weight, c.g., speed, altitude, flaps, slats, gear, speed brakes, and airplane system degradation should be considered.

(6) The amount of flight testing should be determined through the cooperative efforts of the assigned project personnel. It is recommended that the procedures that follow be used as a guide in preparing for the flight testing of an initial certification program. Follow-on items relevant to system derivative certification may result in considerably reduced flight testing. However, sufficient testing should be accomplished to assure satisfactory performance. When ground or flight test data, available from similar previously approved installations, are sufficient to properly evaluate a system's performance, additional testing may not be required. In the absence of such data, additional testing or analysis should be presented to substantiate the areas potentially affected.

(7) Particular attention should be given to those installations where an external piece of gear, such as an antenna, could affect the flight characteristics. All installations of this nature should be evaluated by the flight test pilot.

(8) Installations that can or may change the established limitations, flight characteristics, performance, operating procedures, or any required systems require approval by an FAA Aircraft Certification Office (ACO) flight test branch. New installations of equipment in the cockpit, or modifications that affect existing equipment in the cockpit, should be evaluated through the cooperative efforts of the FAA, the project engineer, and the assigned flight test pilot, and assessed for the need of an FAA flight test demonstration.

(9) Throughout the systems/equipment evaluation, the operation of annunciators should be assessed to determine that proper conspicuity and display are provided to the appropriate flight crewmember. Any mode of operation selected by a manual action, or automatically, should be positively identified. Any submode should be evaluated to determine the need for annunciation.

b. Procedures - Communications.

(1) VHF Systems.

(i) Airplanes to be operated above 18,000 ft. Intelligible communications should be provided between the airplane and facilities throughout circle-turns within 160 NM of an FAA approved ground facility and above minimum radio line-of-sight with no intervening terrain. Bank angles up to 10 degrees on all headings should be used. Drop outs that are relieved by a reduction in bank angle at the same relative heading to the station are satisfactory. It is suggested that the Long Range Reception Test of paragraph (iv), below, be conducted first. If this test is successful, the circle-turns (within 160 NM) of this paragraph need not be conducted. Skidding turns may be used to minimize turn radius.)

(ii) Airplanes to be operated below 18,000 ft. For airplanes limited to operation below 18,000 ft., intelligible communications should be provided as given in (i) above, except that the distance from the ground facility need not exceed 80 NM.

(iii) Antenna Coverage Measurement. If antenna locations are symmetrical, tests may be conducted using only one direction of turn. When antenna radiation pattern data are available, flight testing in a 360 degree turn may not be necessary, if satisfactory communication is achieved during checks in the vicinity of the predicted bearings and bank angles of worst performance.

(iv) Long Range Reception. At a distance of at least 160 NM (or 80 NM for airplanes to be operated below 18,000 ft.) from the ground facility antenna on a heading and above radio line-of-sight, perform a right and/or left 360 degree turn at a bank angle of at least 10 degrees. Communicate with the ground facility every 10 degrees of turn to test the intelligibility of the signals received at the ground station and in the airplane. The minimum line-of-sight altitude for 160 NM is approximately 17,000 ft. and for 80 NM is approximately 4,000 ft.

If dyed water or other liquid is used, it may be necessary to add chemicals to prevent freezing during the test. Sufficient test maneuvers should be accomplished to ensure that impingement will not occur during any inadvertent discharge from the venting system.

(4) Carburetor vent systems may require flight testing to ensure against stoppage by freezing. Such tests can be conducted in conjunction with the tests required by § 25.1095 and/or § 25.1101 (see the "Procedures" for those sections in this AC).

[118. - 120.] [RESERVED]

CHAPTER 6 - EQUIPMENT

Section 1. GENERAL

170. EQUIPMENT - FUNCTION AND INSTALLATION - § 25.1301.

a. Explanation.

(1) Certification of the installation of modern avionics/electrical systems on airplanes can be summarized, generally, by stating that the systems/equipment must:

- (i) Perform its intended function (§ 25.1301);
- (ii) Be adequately protected for failure conditions (§ 25.1309);
- (iii) Be arranged to provide proper pilot visibility and utilization (as appropriate) (§ 25.1321);
- (iv) Be protected by circuit breakers to preclude failure propagation and/or minimize distress to the airplane's electrical system (§ 25.1357); and
- (v) Be installed in a manner such that operation of the system will not adversely affect the simultaneous operation of any other system (§ 25.1431).

(2) Accordingly, the recommended flight test procedures for equipment covered in Subpart F of 14 CFR part 25 (excluding powerplant instruments, airspeed calibration, safety equipment, and lights) are grouped together under this section and are organized as follows:

- Para. b. Communication Systems.
- Para. c. Navigation Systems.
- Para. d. Instruments and Displays.
- Para. e. Sensors and Warning Systems.
- Para. f. Recording Systems.
- Para. g. Engine Interfacing Systems (autothrottle, thrust rating, ATTCS, etc.).
- Para. h. Stability Augmentation Systems.
- Para. i. All Weather Operation (Reduced Visibility) Systems.

(3) Section 25.1301 refers to each item of installed equipment. Type certification involving equipment approvals is governed by Title 49 United States Code, section 44704. That section requires the Administrator to make, or require the applicant for a type certificate to make, such tests "necessary in the interest of safety." Tests may be necessary in order to allow the Administrator to find that the aircraft is properly designed and manufactured, performs properly, and meets the regulations and minimum standards prescribed under section 44701(a) of Title 49. "Optional equipment," however, is not a term that is meaningful under the Act in connection with the type certification of any given airplane. Where equipment or a system is a part or appearance of the airplane and is designed to aid and will obviously be used by the crew, the statutorily required tests and findings that must be used necessarily account for that equipment, whether or not it is characterized as "optional." Moreover, the regulatory requirement of § 21.21(b)(2) specifies that the Administrator must find that no feature or characteristic of the airplane makes it unsuitable for the category in which certification is requested. Therefore, the extent to which that equipment must be tested or evaluated, in order that the Administrator may make the necessary finding with respect to the whole airplane, is a technical determination within the engineering and operational expertise of the Administrator. (See Advisory Circular 25-10, "Guidance for Installation of Miscellaneous, Non-Required Electrical Equipment," dated March 6, 1987, for further information.)

(4) Criteria and requirements for flight must consider the applicant's engineering analysis and laboratory (simulator) test program. The combination of analysis, laboratory, and flight evaluation will form the whole of the certification requirement and, as such, must be in harmony and provide full evaluation. The flight evaluations supplement the analysis and simulation as required in both the representative operating conditions of the airplane and for analysis of the airplane modes of operation and configuration conditions.

(5) If the measured carbon dioxide concentrations exceed three percent by volume (corrected to Sea Level, Standard Day conditions), protective breathing equipment should be provided for each flight crewmember on flight deck duty.

(6) Appropriate emergency operating procedures should be entered in the Airplane Flight Manual.

[166. - 169.] [RESERVED]

Section 3. FUEL SYSTEM COMPONENTS

[121. - 126.] [RESERVED]

127. FUEL JETTISONING SYSTEM - § 25.1001.

a. Explanation.

(1) Section 25.1001(a) prescribes the conditions governing the need for installation of fuel jettisoning systems; if an airplane can meet the climb requirements of §§ 25.119 and 25.121(d), at the weight existing after a 15 minute flight consisting of a maximum weight takeoff and immediate return landing, a fuel jettisoning system is not required. Credit is given for the actual or computed weight of fuel consumed in the 15 minute flight using the airplane configurations, power settings, and speeds appropriate to each flight segment.

(2) If a fuel jettisoning system is required, § 25.1001(b) prescribes the conditions that will determine the minimum flow rate of the system. Section 25.1001(b) requires the fuel jettisoning system to be capable of reducing the weight of the airplane, within 15 minutes of operation, from that specified in § 25.1001(a) to a weight at which the airplane will meet the climb requirements of §§ 25.119 and 25.121(d). Since the weight defined in § 25.1001(a) allows credit for a 15 minute fuel burn, a literal interpretation of this rule would result in a 15 minute jettisoning period beginning after a 15 minute takeoff, go-around, and approach flight. In application, the 15 minute jettisoning period will occur during a 30 minute flight in which weight reduction credit will be given for the fuel consumed and jettisoned. The airplane must be able to meet the specified climb requirements at the weight existing at the end of this 30 minute flight.

(3) Airplanes should also be investigated for other elements that may limit their ability to safely accomplish an immediate return landing without a fuel jettisoning system. Advances in wing design and propulsion technology have resulted in transport category airplane designs that can take off at weights considerably above their maximum landing weights. Many of these airplanes are capable of meeting the climb requirements of §§ 25.119 and 25.121(d), following a 15 minute flight, without a fuel jettisoning system. Some of these airplanes, however, may not be capable of landing without exceeding other certification limits such as maximum brake energy, landing distance, and tire speed. This is particularly true when non-normal procedures, implemented as a result of failures that have been shown to be foreseeable events, call for reduced flap settings and increases of as much as 30 knots, for a given weight, over speeds associated with the normal landing flap setting. Margins to flap placard limit speeds and flap load-relief activation speeds should be established and maintained for non-normal configurations that may be used in immediate return landings.

(4) An additional consideration that is representative of actual operating conditions is the ability to perform a go-around from field elevation with the flaps in the approach position and the landing gear down. Through compliance with § 25.1001(b), assurance will be obtained that the airplane can accomplish an all-engines-operating balked landing go-around, with normal landing flaps, followed by a one-engine-inoperative climb-out with approach flaps and landing gear up. However, non-normal procedures generally call for one-engine-inoperative landings to be made with the flaps in the position used to show compliance with the approach climb requirements of § 25.121(d). It should therefore be determined under what combinations of weight, altitude, and temperature the airplane can establish a positive rate-of-climb with one-engine-inoperative and the other operating at go-around thrust, with the flaps in the appropriate go-around position and the landing gear down.

b. Procedures. The basic purpose of these tests is to verify that the minimum jettisoning rate will allow the airplane to safely execute an immediate return landing, and to determine that the required amount of fuel may be safely jettisoned under reasonably anticipated operating conditions within the prescribed time limit, without danger from fire, explosion, or adverse effects on the flying qualities.

(1) Jettisoning Rate

(i) In determining the minimum jettisoning rate, the tanks, tank combinations, or fuel feed configurations that are critical should be selected for demonstrating the flow rate.

rate.

(ii) It should be determined if airplane altitude or configuration has an effect on the jettisoning

(iii) It should be demonstrated that the means to prevent jettisoning of the fuel in the tanks used for takeoff and landing, below the level to meet the requirements of §§ 25.1001(e) and (f), are effective.

(iv) It should be demonstrated that operation of the jettisoning system does not have a detrimental effect on operation of the engines (and the APU if installed and approved for inflight operation).

(2) Fire Hazard

(i) The fuel jettisoning flow pattern should be demonstrated from all normally used tank or tank combinations on both sides of the airplane, whether or not both sides are symmetrical.

(ii) The fuel jettisoning flow pattern should be demonstrated for the flight conditions specified in §§ 25.1001(d)(1), (2), and (3). Steady-state sideslips anticipated during operation should be conducted during flight conditions.

(iii) Fuel in liquid or vapor form should not impinge upon any external surface of the airplane during or after jettisoning. Colored fuel, or surface treatment that liquid or vaporous fuel changes the appearance of, may be used on airplane surfaces for detection purposes. Other equivalent methods for detection may be acceptable.

(iv) Fuel in liquid or vapor form should not enter any portion of the airplane during or after jettisoning. The fuel may be detected by its scent, a combustible mixture detector, or by visual inspection. In pressurized airplanes, the check for the presence of liquid or vaporous fuel should be accomplished with the airplane unpressurized.

(v) There should be no evidence of leakage after the fuel jettisoning valve is closed.

(vi) Testing should be conducted with the wing flaps in all available positions and during transition from each position to the next. If there is any evidence that wing control surface (flaps, slats, etc.) positions may adversely affect the flow pattern and allow fuel to impinge on the airplane, the airplane should be placarded and a limitation noted in the Airplane Flight Manual.

(3) Control.

(i) Changes in the airplane control qualities during the fuel jettisoning tests should be investigated, including asymmetrical jettisoning.

(ii) Discontinuance of fuel jettisoning should be demonstrated in flight.

(4) **Residual Fuel.** The quantity of usable fuel that cannot be jettisoned should be determined to meet the requirements of §§ 25.1001(e) or (f), as applicable. One acceptable means to show compliance with the requirement for sufficient fuel remaining to permit continued flight has been to drain the remaining fuel from the test tank(s) after landing; applicants may propose other means of compliance.

Section 9. POWERPLANT FIRE PROTECTION

[155, - 158.] [RESERVED]

159. **DRAINAGE AND VENTILATION OF FIRE ZONES.** - § 25.1187.

a. **Explanation.** - There must be complete drainage of each part of each designated fire zone to minimize the hazards resulting from failure or malfunctioning of any component containing flammable fluids. The drainage means must be:

(1) Effective under conditions expected to prevail when drainage is needed;

(2) Arranged so that no discharged fluid will cause an additional fire hazard; and

(3) Arranged so that no discharged fluid will enter any other fire zone.

b. **Procedures.**

For detailed information related to flammable fluid drainage, ventilation, and fire protection, refer to Advisory Circular 25.1187, "Minimization of Flammable Fluid Fire Hazards," (to be released).

[160, - 164.] [RESERVED]

165. **IRE EXTINGUISHING AGENTS.** - § 25.1197.

a. **Explanation.** Carbon Dioxide in Flightcrew Compartments. Carbon dioxide has been found to adversely affect flightcrew personnel in the performance of their duties. Therefore, in airplanes equipped with built-in carbon dioxide fuselage compartment fire extinguisher systems, the carbon dioxide concentration occurring at the flightcrew stations as a result of discharging the fire extinguishers should be determined in accordance with the procedures of this section (also see paragraph 84 of this AC), except that such determination is not considered necessary if:

(1) Five pounds or less of carbon dioxide will be discharged into any one such fuselage compartment in accordance with established fire control procedures; or

(2) Protective breathing equipment is provided for each flight crewmember on flight deck duty.

b. **Procedures.** Flight Test Investigation.

(1) The carbon dioxide concentrations at breathing level at the flightcrew stations should be determined in flight tests during which fuselage compartment fire extinguishers are discharged in accordance with established fire control procedures. Since carbon dioxide is heavier than air, a nose-down attitude is likely to produce the critical concentrations in the crew compartment. Perform the tests described in paragraphs (2) and (3) below.

(2) A rapid descent at the "maximum operating limit speed" of the airplane with the flaps and landing gear up.

(3) A rapid descent with the flaps and landing gear down, at the maximum permissible speed for this configuration. If it appears that any other condition is likely to be critical on a particular airplane, it should also be investigated.

(4) In the flight tests specified above, it will be permissible to institute emergency ventilating procedures immediately prior to or following the discharge of carbon dioxide, provided such procedures can be accomplished easily and quickly by the flightcrew, and do not appreciably reduce the effectiveness of the fire protection system.

Section 4. OIL SYSTEM [RESERVED]

Section 8. POWERPLANT CONTROLS AND ACCESSORIES

[141. - 154.] [RESERVED]

[128. - 130.] [RESERVED]

Section 5. COOLING

Section 7. EXHAUST SYSTEM

137. GENERAL - § 25.1121.

a. Explanation. Section 25.1121(a) - Carbon monoxide contamination- Carbon monoxide detection tests are conducted in accordance with this requirement to determine that the disposal of exhaust gases from each exhaust system does not cause carbon monoxide contamination of any personnel compartment.

b. References. Also see information related to the evacuation of other personnel compartment atmosphere contaminants contained in paragraphs 84 and 165 of this AC addressing the requirements of §§ 25.831 and 25.1197, respectively.

[138. - 140.] [RESERVED]

Section 6. INDUCTION SYSTEM

131. AIR INDUCTION - § 25.1091

(iv) The secondary effects of falling and blowing snow should also be considered in the evaluation of susceptibility to, and protection from, ice accumulations. The critical ambient temperatures should be defined; this evaluation should take into consideration not only temperatures in the immediate vicinity of the freezing point, where "wet, sticky snow" is likely, but also colder temperatures where snow may adhere to partially heated interior inlet surfaces, melt, and refreeze in a colder location. Any hardware or ancillary systems (e.g., screens, particle separators, oil coolers) installed in turbine engine inlets may facilitate the accumulation of snow and potential for generation of ice. The effects of falling and blowing snow should be evaluated for both ground and flight conditions. The number of actual airplane tests within the critical snow and temperature environment should be maximized. The test article must be in production configuration with respect to surface finish, texture, and material type, to assure accurate representation of the in-service configuration. Recognizing that the desired atmospheric conditions may be difficult to find, some conditions may be substantiated by analysis, provided that analysis is supported by some form of test data (e.g., temperature survey data).

(v) It would be inconsistent to consider that § 25.1093(b) pertains only to the engine or engine inlet lip. The wording is broad and objective. It should be noted that the icing requirements pertaining specifically to the engine are included in § 33.68. Section 25.1093(b) was included to assure that the engine, as installed in the airplane, did not suffer adverse effects when the airplane was subjected to the icing envelope requirements covered by Appendix C to Part 25. It is not logical to exclude any part of the airplane that might shed ice so as to produce an adverse effect on the engine.

(vi) The foregoing discussions are intended to describe the minimum program to achieve certification for flight in icing conditions.

(2) Procedures. None.

[133. - 136.] [RESERVED]

a. Explanation - § 25.1091(d)(2). The turbine engines of transport category airplanes are susceptible to surge, stall, and flameout when excessive amounts of water are ingested. The certification requirements for turbine engines include the demonstration of a capability to operate in simulated rainfall with no adverse operating effects. The quantities of water spray that may be directed toward the engine inlets, resulting from the airplane passing through standing water on taxi and runways, may exceed that used in the simulated rainfall ingestion testing. This becomes particularly important during takeoff, where the engines are operated at high power settings and the airplane will experience a wide range of speeds. During takeoff and landing ground rolls, the airplane's tires generate bow waves, side spray, and "rooster tails" (spray that is thrown off the tires as they rotate), which can collect into concentrated streams of water that, if ingested into the engines, Auxiliary Power Units (APU), or air conditioning systems, could affect operation sufficiently to cause an unsafe condition. Similarly, water ingestion into the airspeed system during ground operations may cause erratic cockpit indications of airspeed. It is often practical to investigate these effects concurrently with the engine water ingestion evaluation.

b. References:

- (1) Advisory Circular 20-124, Water Ingestion Testing for Turbine Powered Airplanes, dated September 30, 1985.
- (2) Advisory Circular 91-6A, "Performance Information for Operation with Water, Slush, Snow or Ice on the Runway," dated May 24, 1978.

c. Procedures:

- (1) Method of Compliance. The applicant may show compliance with the requirements of § 25.1091(d)(2) by test or by reasonable analysis. The analytical approach may be acceptable in cases where an airplane and/or its engines were modified, but the overall geometry and configuration remained unchanged.
- (2) Water Depth. Takeoffs should not be attempted when the depth of standing water, slush, or wet inch is greater than one-half inch over an appreciable part of the runway (Ref. AC 91-6A). Therefore, one-half inch of standing water is the accepted criteria for conducting tests to demonstrate compliance with the water ingestion requirements of § 25.1091(d)(2). Testing may be conducted in specially constructed water test beds, where the selected water depth is maintained over not less than 90 percent of the test bed area. If the airplane successfully completes testing with a one-half inch water depth, no operating limitations will be imposed for wet runway operations.
- (3) Airplane Configuration. Testing should be conducted to demonstrate all critical phases of taxi, takeoff, and landing operations. High lift devices and landing gear doors should be in the position appropriate to each phase of operation tested. All portions of the airplane that may affect water spray patterns should be in the production configuration desired for approval (e.g., chine tires, fenders). The most critical powerplant operating configuration (bleed air, electrical load, ignition system, etc.) that is consistent with the applicant's recommended procedures for operation on wet runways should be used.
- (4) Test Facility. The test facility must have adequate space for simulated takeoff and landing runs. Intermediate dams may be used in the water test bed to maintain the selected water depth over not less than 90 percent of the test bed area. The test bed length should not be less than that required to produce a spray pattern of one second duration at critical test speeds. The test bed width need only accommodate one landing gear, if acceptable data are presented to the FAA that show the combined nose and main gear spray is not more hazardous than the spray produced by either gear separately.
- (5) Test Procedures. The tests should be conducted with the appropriate thrust or power setting. To establish the critical speed ranges, test runs should be made through the water test bed in speed increments of not more than 20 knots. If the rotated airplane attitude is suspected to be critical, at least one run at V_R should be conducted with the airplane rotated to the normal rotation pitch attitude. If thrust reversers or reversing propellers are provided, testing should also be conducted with those systems operating.

data:

(6) Test Data. The applicant is expected to provide personnel and equipment to collect the following

(i) Test Site Data. The outside air temperature, wind velocity, and water depth should be recorded before each test run.

(ii) Airplane Performance Data. The airplane velocity should be recorded when it enters and exits the water test bed. Engine rotor speeds and Interstage turbine temperature (ITT) (or exhaust gas temperature (EGT), as applicable) should be recorded and any engine abnormal engine sounds noted.

(iii) Water Spray Pattern. Appropriate areas of the airplane should be coated with agents that will permit identification of water spray impingement. Suitable high speed photography or video equipment should be utilized to record the origin, trajectory, and configuration of the water spray.

(iv) Pilot Comments. Pilot comments should be noted to determine if the takeoff would have been affected by abnormal audible engine sounds, airplane instrument anomalies, etc.

(7) Test Results. No hazardous quantities of water are considered to have been ingested when review of the collected test data shows that:

(i) No engine flameout, performance degradation, distress, or airspeed fluctuations occurred that would create a safety hazard.

(ii) No abnormal engine sounds occurred, such as pops or bangs, or cockpit instrument indications of incipient engine surge or stall, or they were not of sufficient magnitude to cause a pilot in service to abort the planned operation.

132. INDUCTION SYSTEM ICING PROTECTION - § 25.1093.

a. Reference. Advisory Circular 20-73, Aircraft Ice Protection, dated April 21, 1971.

b. Reciprocating Engines - § 25.1093(a).

(1) Explanation.

(i) Conditions for tests. The carburetor air temperature measurement has been found to provide satisfactory average readings through the use of a minimum of three thermocouples so arranged as to give an average air temperature. This indicator should be calibrated prior to the test. Operationally, it has been determined that the tests should be conducted at an altitude where the free air temperature is 30° F, or at two altitudes of different temperatures, one of which is near 30° F.

(ii) Configuration. The test should be conducted in the configuration that follows:

(A) Weight - optional.

(B) C.G. Position - optional.

(C) Wing Flap Position - optional.

(D) Landing Gear Position - optional.

(E) Engines - 60 percent maximum continuous power.

(F) Cowl Flaps - appropriate for flight condition.

(G) Mixture Setting - normal cruising position.

(2) Procedures. Test procedures and required data.

(i) After all temperatures have stabilized (i.e., when the rate of temperature change is less than 2° F per minute), and with the airplane in level flight and full cold carburetor at 60% maximum continuous power, the following data should be recorded:

(A) Pressure altitude.

(B) Ambient air temperature.

(C) Indicated airspeed.

(D) Carburetor air temperature.

(E) Engines, R.P.M. and manifold pressure.

(F) Torque pressure.

(G) Mixture setting.

(H) Cowl flap setting.

(ii) Preheat should then be applied slowly (power may be restored to 60 percent maximum continuous at the applicant's option) and the above data recorded again after the temperatures have stabilized. The carburetor heat rise is determined by comparing the results of the data obtained with and without preheat.

c. Turbine Powered Airplanes - § 25.1093(b).

(1) Explanation.

(i) Section 25.1093(b) requires that each turbine engine operate throughout its flight power range without adverse effect on engine operation or serious loss of power or thrust in the icing conditions specified, including those related to falling and blowing snow. This requirement must be met for all operating conditions of the airplane and is not limited to operations where icing can be predicted or when icing penetrations are specifically intended. It is clear that the engines require protection against the possible hazardous effects of ice ingestion for all operating conditions, while the remaining airframe need be protected only if certification for flight in icing conditions is desired. This can also be verified by a review of §§ 25.1093(b), 25.1419, and 33.68.

(ii) One purpose of flight in natural and/or tanker-provided icing conditions is to demonstrate that chunks of ice discharged from unprotected surfaces do not cause damage to the engine or other critical parts of the airplane, and to demonstrate that ice discharged from protected surfaces after an undetected icing encounter, during which the ice protection system was inoperative, does not cause engine damage or malfunction, or damage to other critical parts of the airplane. In order to accomplish these objectives, the airplane should be exposed to an icing condition of a magnitude and duration sufficient to accumulate enough ice to produce an acceptable demonstration. If, after installation on the airplane, it is possible for the engines to ingest ice shed from the airframe, which will cause an adverse effect or serious loss of power or thrust on the engine, compliance with § 25.1093(b) has not been achieved, and the required level of airworthiness for the engine installation has not been obtained.

(iii) It has been established from experience that turbine engines can be affected seriously and adversely by inadvertent in-flight ice encounters in which only a minor performance loss could be attributable to the amount of ice accumulated on the airframe. Based upon this experience, it was deemed necessary to require a higher level of ice protection for the engines than was found necessary for the airframe. The requirements of §§ 25.1093(b), 25.1419, and 33.68 reflect this concept. Satisfactory operation of protected surfaces at the design point condition, as described in Advisory Circular 20-73, should be demonstrated by icing tunnel tests or by analysis supported by tests. The ability to de-ice and anti-ice protected surfaces should be demonstrated during the natural and/or tanker-provided icing tests.